

02

Hydraulics

EMB DIN 2353 Metric Steel Compression Fittings, Donaldson Filtration Systems, Gates Hydraulic Hose and Couplings, MHA Zentgraf Valves, Burnett and Hillman BSP Adaptors, Cejn® Couplings, RSB Clamps





DIN 2353 Couplings and Fittings

A division of Gates Europe, EMB is one of the largest European manufacturers of DIN 2353 cutting ring couplings to ISO EN 9000 / 2000 Quality Approval.

02

EMB produces:

- A comprehensive range of metric light, light-heavy and heavy duty DIN 2353 hydraulic fittings (mild carbon steel, stainless steel, brass)
- FS (Form and Seal) system – tube end forming
- Hydraulic adaptors (BSP / ORFS / JIC)
- Weld fittings
- Test and monitoring systems
- 37° din flare adaptor system
- Pre-assembly tools and machines



Applications using EMB Fittings include:

- Construction machinery
- Moulding machinery
- Agricultural machinery
- Elevators and fork-lifts
- Machine Tools
- Shipbuilding and offshore
- Vehicles and railway
- Hydraulic aggregates and systems
- Distribution



EMB pipe screw joints and accessories correspond to the DIN 2353 / ISO 8434-1 and 8434-4 standards.

Rated pressure has a safety factor of 4 (DIN 3859), but EMB precision hydraulic fittings generally exceed the standardised pressure rating.



EMB Working Pressures are in Excess of DIN Standards up to 800 bar

- 4 mm OD to 8 mm OD
- 6 mm OD to 42 mm OD
- 6 mm OD to 38 mm OD

Light Light Series
Light Series
Heavy Series

Manufactured to DIN 2353, ISO 8434-1 and 8434-4



Pressure Rating (ISO 8434-1) PN bar

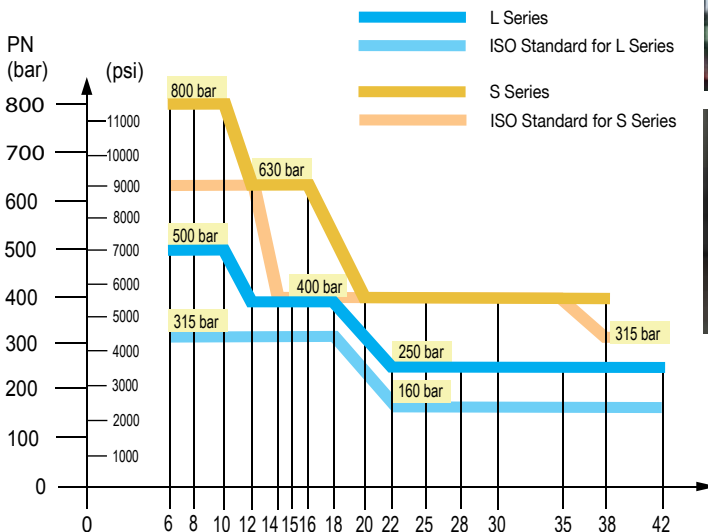

Light Light Series	Light Series			Heavy Series		
4mm OD - 8mm OD	6mm OD - 10mm OD	12mm OD - 18mm OD	22mm OD - 42mm OD	6mm OD - 10mm OD	12mm OD - 16mm OD	22mm OD - 38mm OD
100 bar	500 bar	400 bar	250 bar	800 bar	630 bar	400 bar

EMB DS Cutting Ring

Easy to Assemble



2 Cutting Edges

Cannot be Over-Tightened

EMB's steel and stainless steel "DS" cutting ring is a rigid, optimised two-edge cutting ring featuring a secondary metallic seal.

Each cutting edge cuts in sequence, resulting in the capacity to withstand larger pull out loads and provide increased tube stability.

The second cutting edge reduces both transverse force and torque, and functions as a "physical stop" that prevents overtightening during assembly. ①

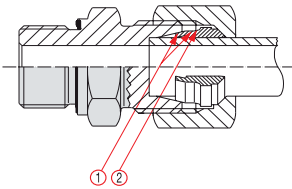

Evenly distributed force within the cone guarantees security. ③

A rising strength is imparted to the whole length of the ring and flows over the ring on to the body cone and the cone of the nut. This effect arises from the conical design of the inside end. ④

The conical surface opposite the cutting edges is highly finished, thereby reducing the loss by friction during the installation and resulting in a stronger grip. Besides higher stability, the reinforced end of the DS ring reduces friction and takes the pressure off of the base of the nut. ⑤

The required reduction of the cross-section optimises the radial stability and thereby keeps the tube secure. The stop area clearly limits overwinding by the bearing at the stud's front surface. ⑥

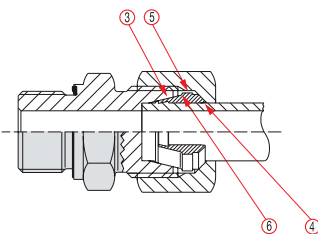

The DIN 2353 Standard

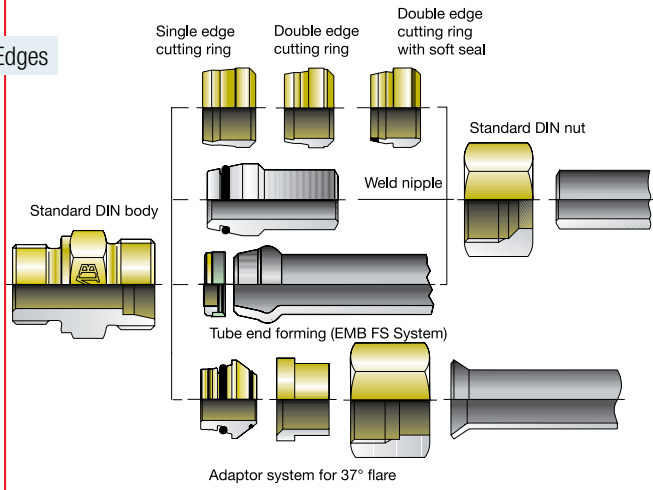

DIN 2353 / ISO 8434

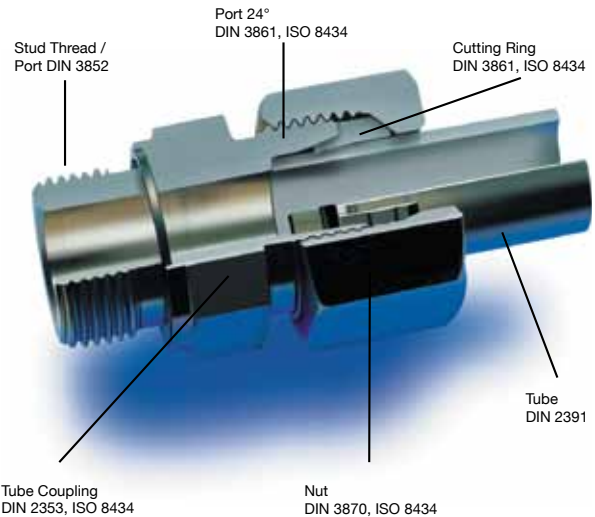

EMB Safety in Assembly

- EMB has a safe assembly solution for all applications
- Convenient, simple and short assembly times following straightforward instructions

- 100% controlled final assembly of cutting rings
- Final turning in the stud only 30° (starting from pressure point)
- 50% controlled pre-assembly of other manufacturers' cutting rings



EMB Opticam, Type CAM 34



Tube Nuts & Cutting Rings

Tube Nut
Light Light Series



PGC: 234	OD (mm)	Price
MN4LL	4	£0.39
MN6LL	6	£0.36
MN8LL	8	£0.40

Light Series

PGC: 234	OD (mm)	Price
MN6L	6	£0.39
MN8L	8	£0.44
MN10L	10	£0.48
MN12L	12	£0.67
MN15L	15	£0.87
MN18L	18	£1.59
MN22L	22	£2.29
MN28L	28	£4.26
MN35L	35	£5.42
MN42L	42	£5.56

Heavy Series

PGC: 234	OD (mm)	Price
MN6S	6	£0.44
MN8S	8	£0.50
MN10S	10	£0.68
MN12S	12	£0.83
MN14S	14	£1.22
MN16S	16	£1.68
MN20S	20	£2.49
MN25S	25	£4.80
MN30S	30	£5.93
MN38S	38	£8.69

Cutting Ring
Light Light Series



PGC: 234	OD (mm)	Price
MF4LL	4	£0.43
MF6LL	6	£0.41
MF8LL	8	£0.44

Light Series

PGC: 234	OD (mm)	Price
MF6LS	6	£0.36
MF8LS	8	£0.39
MF10LS	10	£0.45
MF12LS	12	£0.48
MF15L	15	£0.59
MF18L	18	£0.81
MF22L	22	£0.98
MF28L	28	£1.18
MF35L	35	£1.92
MF42L	42	£2.71

Heavy Series

PGC: 234	OD (mm)	Price
MF14S	14	£0.88
MF16S	16	£0.87
MF20S	20	£1.12
MF25S	25	£1.39
MF30S	30	£1.78
MF38S	38	£2.53

DIN 2353 Metric Steel Compression Fittings



Blanking Caps & Plugs

Blanking Cap
24° Cone
Light Series



PGC: 234	OD (mm)	Price
MBC6L	6	£3.43
MBC8L	8	£3.93
MBC10L	10	£4.53
MBC12L	12	£5.41
MBC15L	15	£7.51
MBC18L	18	£11.36
MBC22L	22	£15.91
MBC28L	28	£29.03
MBC35L	35	£43.19
MBC42L	42	£60.06

Heavy Series

PGC: 234	OD (mm)	Price
MBC6S	6	£3.99
MBC8S	8	£4.66
MBC10S	10	£5.50
MBC12S	12	£6.45
MBC14S	14	£11.43
MBC16S	16	£12.19
MBC20S	20	£17.91
MBC25S	25	£30.14
MBC30S	30	£44.03
MBC38S	38	£63.63

Blanking Plug
Light Series



PGC: 234	OD (mm)	To Suit Nut (mm)	Price
MBP6LS	6	6	£0.91
MBP8LS	8	8	£1.13
MBP10LS	10	10	£1.20
MBP12LS	12	12	£1.43
MBP15L	15	15	£1.92
MBP18L	18	18	£2.09
MBP22L	22	22	£3.27
MBP28L	28	28	£5.48
MBP35L	35	35	£10.77
MBP42L	42	42	£16.65

Heavy Series

PGC: 234	OD (mm)	To Suit Nut (mm)	Price
MBP14S	14	14	£3.60
MBP16S	16	16	£2.05
MBP20S	20	20	£3.11
MBP25S	25	25	£4.36
MBP30S	30	30	£7.58
MBP38S	38	38	£13.97

Straight Couplings

Straight Coupling
Light Light Series



PGC: 234	OD (mm)	Price
MSC4LL	4	£2.73
MSC6LL	6	£3.03
MSC8LL	8	£3.09

Light Series

PGC: 234	OD (mm)	Price
MSC6L	6	£2.67
MSC8L	8	£2.88
MSC10L	10	£3.41
MSC12L	12	£4.09
MSC15L	15	£5.63
MSC18L	18	£8.59
MSC22L	22	£11.78
MSC28L	28	£21.16
MSC35L	35	£29.05
MSC42L	42	£37.36

Heavy Series

PGC: 234	OD (mm)	Price
MSC6S	6	£3.21
MSC8S	8	£3.60
MSC10S	10	£4.36
MSC12S	12	£4.99
MSC14S	14	£9.21
MSC16S	16	£9.33
MSC20S	20	£13.75
MSC25S	25	£23.20
MSC30S	30	£32.27
MSC38S	38	£43.76

Equal Bulkheads

Equal Bulkhead
Light Series



PGC: 234	OD (mm)	Price
MBH6L	6	£5.03
MBH8L	8	£5.19
MBH10L	10	£6.35
MBH12L	12	£7.56
MBH15L	15	£11.05
MBH18L	18	£17.72
MBH22L	22	£22.74
MBH28L	28	£34.82
MBH35L	35	£53.86
MBH42L	42	£72.88

Heavy Series

PGC: 234	OD (mm)	Price
MBH6S	6	£9.15
MBH8S	8	£10.07
MBH10S	10	£11.58
MBH12S	12	£12.75
MBH14S	14	£22.81
MBH16S	16	£21.35
MBH20S	20	£33.51
MBH25S	25	£50.57
MBH30S	30	£85.64
MBH38S	38	£97.78



DIN 2353 Metric Steel Compression Fittings

Bulkhead Elbows

Bulkhead Elbow

Light Series



PGC: 234	OD (mm)	Price
MBHE6L	6	£9.89
MBHE8L	8	£10.28
MBHE10L	10	£11.38
MBHE12L	12	£14.02
MBHE15L	15	£16.87
MBHE18L	18	£23.66
MBHE22L	22	£37.18
MBHE28L	28	£57.41
MBHE35L	35	£85.52
MBHE42L	42	£121.22

Heavy Series

PGC: 234	OD (mm)	Price
MBHE6S	6	£11.54
MBHE8S	8	£12.80
MBHE10S	10	£16.03
MBHE12S	12	£16.58
MBHE14S	14	£92.37
MBHE16S	16	£23.98
MBHE20S	20	£37.64
MBHE25S	25	£61.24
MBHE30S	30	£83.60
MBHE38S	38	£125.98

Equal Crosses

Equal Cross

Light Series



PGC: 234	OD (mm)	Price
MX6L	6	£24.37
MX8L	8	£26.77
MX10L	10	£28.99
MX12L	12	£32.11
MX15L	15	£38.11
MX18L	18	£49.27
MX22L	22	£78.76
MX28L	28	£94.55
MX35L	35	£129.49
MX42L	42	£199.03

Heavy Series

PGC: 234	OD (mm)	Price
MX6S	6	£29.16
MX8S	8	£31.73
MX10S	10	£34.18
MX12S	12	£36.25
MX14S	14	£53.97
MX16S	16	£52.88
MX20S	20	£75.97
MX25S	25	£94.59
MX30S	30	£127.83
MX38S	38	£201.88

Equal Elbows

Equal Elbow

Light Light Series



PGC: 234	OD (mm)	Price
ME4LL	4	£6.15
ME6LL	6	£6.22
ME8LL	8	£6.78

Light Series

PGC: 234	OD (mm)	Price
ME6L	6	£6.11
ME8L	8	£6.48
ME10L	10	£6.90
ME12L	12	£8.16
ME15L	15	£11.06
ME18L	18	£15.07
ME22L	22	£21.17
ME28L	28	£33.64
ME35L	35	£49.09
ME42L	42	£64.35

Heavy Series

PGC: 234	OD (mm)	Price
ME6S	6	£7.01
ME8S	8	£7.49
ME10S	10	£8.89
ME12S	12	£9.81
ME14S	14	£16.64
ME16S	16	£15.64
ME20S	20	£21.61
ME25S	25	£35.53
ME30S	30	£50.15
ME38S	38	£71.34

Equal Tees

Equal Tee

Light Light Series



PGC: 234	OD (mm)	Price
MT4LL	4	£7.63
MT6LL	6	£7.74
MT8LL	8	£8.93

Light Series

PGC: 234	OD (mm)	Price
MT6L	6	£7.91
MT8L	8	£8.53
MT10L	10	£9.43
MT12L	12	£11.44
MT15L	15	£14.97
MT18L	18	£20.71
MT22L	22	£29.32
MT28L	28	£47.55
MT35L	35	£64.17
MT42L	42	£90.38

Heavy Series

PGC: 234	OD (mm)	Price
MT6S	6	£9.15
MT8S	8	£10.07
MT10S	10	£11.58
MT12S	12	£12.75
MT14S	14	£22.81
MT16S	16	£21.35
MT20S	20	£33.51
MT25S	25	£50.57
MT30S	30	£65.64
MT38S	38	£97.78

Unequal Tees

Unequal Tee

Light Series



PGC: 234	OD 1 (mm)	OD 2 (mm)	OD 3 (mm)	Price
MT6-10-6L	6	10	6	£38.14
MT6-8-6L	6	8	6	£23.76
MT8-6-8L	8	6	8	£15.50
MT8-10-8L	8	10	8	£34.81
MT8-12-8L	8	12	8	£27.44
MT10-8-10L	10	8	10	£23.34
MT12-6-12L	12	6	12	£25.60
MT12-8-8L	12	8	8	£28.07
MT12-8-12L	12	8	12	£20.34
MT12-10-10L	12	10	10	£30.74
MT12-10-12L	12	12	12	£20.64
MT12-15-12L	12	15	12	£32.53
MT15-6-15L	15	6	15	£48.66
MT15-10-15L	15	10	15	£34.37
MT15-12-15L	15	12	15	£30.31
MT18-10-10L	18	10	10	£70.12
MT18-10-18L	18	10	18	£41.21
MT18-12-18L	18	12	18	£42.07
MT18-15-18L	18	15	18	£43.67
MT22-10-22L	22	10	22	£79.53
MT22-12-22L	22	12	22	£55.42
MT22-15-22L	22	15	22	£54.43
MT22-18-18L	22	18	18	£72.35
MT22-18-22L	22	18	22	£63.62
MT28-10-28L	28	10	28	£120.93
MT28-15-28L	28	15	28	£93.04
MT28-22-22L	28	22	22	£122.08
MT28-22-28L	28	22	28	£89.75

Heavy Series

PGC: 234	OD 1 (mm)	OD 2 (mm)	OD 3 (mm)	Price
MT10-6-10S	10	6	10	£35.36
MT12-8-12S	12	8	12	£46.76
MT12-10-12S	12	10	12	£72.00
MT12-16-12S	12	16	12	£44.41
MT16-6-16S	16	6	16	£63.87
MT16-8-16S	16	8	16	£47.56
MT16-10-16S	16	10	16	£40.21
MT16-12-16S	16	12	16	£43.75
MT16-20-16S	16	20	16	£72.77
MT20-10-20S	20	10	20	£97.87
MT20-12-20S	20	12	20	£97.99
MT20-16-20S	20	16	20	£75.30
MT20-25-20S	20	25	20	£97.31
MT25-16-25S	25	16	25	£87.49
MT25-20-25S	25	20	25	£95.25



DIN 2353 Metric Steel Compression Fittings

Male Stud Couplings Form A

Male Stud Coupling Form A

Male Thread BSPP
Light Series



• Can be used with a bonded seal or 60° cone

PGC: 234	OD (mm)	BSPP	Price
MMC6-1/8L	6	1/8	£1.64
MMC6-1/4L	6	1/4	£2.25
MMC8-1/8L	8	1/8	£5.70
MMC8-1/4L	8	1/4	£2.20
MMC8-3/8L	8	3/8	£4.99
MMC10-1/4L	10	1/4	£2.45
MMC10-3/8L	10	3/8	£3.12
MMC10-1/2L	10	1/2	£5.53
MMC12-1/4L	12	1/4	£5.80
MMC12-3/8L	12	3/8	£4.43
MMC12-1/2L	12	1/2	£4.67
MMC12-3/4L	12	3/4	£16.06
MMC15-3/8L	15	3/8	£5.76
MMC15-1/2L	15	1/2	£5.04
MMC15-3/4L	15	3/4	£16.84
MMC18-3/8L	18	3/8	£14.63
MMC18-1/2L	18	1/2	£9.04
MMC18-3/4L	18	3/4	£17.23
MMC22-1/2L	22	1/2	£13.67
MMC22-3/4L	22	3/4	£13.55
MMC22-1L	22	1	£27.63
MMC28-1/2L	28	1/2	£31.59
MMC28-3/4L	28	3/4	£30.47
MMC28-1L	28	1	£15.81
MMC28-11/4L	28	1 1/4	£36.11
MMC35-1L	35	1	£37.84
MMC35-11/4L	35	1 1/4	£25.15
MMC42-11/2L	42	1 1/2	£32.27

Male Stud Coupling Form A

Body Only
Male Thread BSPP
Light Series



• Can be used with a bonded seal or 60° cone

PGC: 234	OD (mm)	BSPP	Price
XMMC6-1/8L	6	1/8	£1.53
XMMC6-1/4L	6	1/4	£2.10
XMMC8-1/8L	8	1/8	£4.80
XMMC8-1/4L	8	1/4	£1.89
XMMC8-3/8L	8	3/8	£4.10
XMMC10-1/4L	10	1/4	£2.33
XMMC10-3/8L	10	3/8	£2.20
XMMC10-1/2L	10	1/2	£7.25
XMMC12-1/4L	12	1/4	£4.16
XMMC12-3/8L	12	3/8	£3.78
XMMC12-1/2L	12	1/2	£4.12
XMMC12-3/4L	12	3/4	£15.28
XMMC15-3/8L	15	3/8	£4.51
XMMC15-1/2L	15	1/2	£3.74
XMMC15-3/4L	15	3/4	£17.15
XMMC18-3/8L	18	3/8	£12.09
XMMC18-1/2L	18	1/2	£6.11
XMMC18-3/4L	18	3/4	£14.48
XMMC22-1/2L	22	1/2	£11.14
XMMC22-3/4L	22	3/4	£9.57
XMMC22-1L	22	1	£24.66
XMMC28-1/2L	28	1/2	£26.77
XMMC28-3/4L	28	3/4	£26.46
XMMC28-1L	28	1	£11.08
XMMC28-11/4L	28	1 1/4	£31.59
XMMC35-1L	35	1	£32.77
XMMC35-11/4L	35	1 1/4	£18.21
XMMC42-11/2L	42	1 1/2	£25.50

Heavy Series

PGC: 234	OD (mm)	BSPP	Price
MMC6-1/4S	6	1/4	£2.41
MMC6-3/8S	6	3/8	£5.41
MMC8-1/4S	8	1/4	£4.09
MMC8-3/8S	8	3/8	£7.76
MMC10-1/4S	10	1/4	£6.36
MMC10-3/8S	10	3/8	£5.57
MMC10-1/2S	10	1/2	£8.96
MMC12-1/4S	12	1/4	£9.91
MMC12-3/8S	12	3/8	£4.14
MMC12-1/2S	12	1/2	£8.60
MMC12-3/4S	12	3/4	£19.30
MMC14-3/8S	14	3/8	£19.79
MMC14-1/2S	14	1/2	£10.13
MMC16-3/8S	16	3/8	£12.29
MMC16-1/2S	16	1/2	£6.75
MMC16-3/4S	16	3/4	£17.40
MMC20-1/2S	20	1/2	£15.50
MMC20-3/4S	20	3/4	£11.49
MMC20-1S	20	1	£29.75
MMC25-3/4S	25	3/4	£25.68
MMC25-1S	25	1	£18.64
MMC25-11/4S	25	1 1/4	£44.49
MMC30-3/4S	30	3/4	£42.13
MMC30-1S	30	1	£31.54
MMC30-11/4S	30	1 1/4	£42.05
MMC38-1S	38	1	£43.71
MMC38-11/4S	38	1 1/4	£35.86
MMC38-11/2S	38	1 1/2	£38.39

Heavy Series

PGC: 234	OD (mm)	BSPP	Price
XMMC6-1/4S	6	1/4	£1.69
XMMC6-3/8S	6	3/8	£5.92
XMMC8-1/4S	8	1/4	£3.12
XMMC8-3/8S	8	3/8	£7.22
XMMC10-1/4S	10	1/4	£5.16
XMMC10-3/8S	10	3/8	£4.23
XMMC10-1/2S	10	1/2	£7.32
XMMC12-1/4S	12	1/4	£9.26
XMMC12-3/8S	12	3/8	£3.16
XMMC12-1/2S	12	1/2	£6.97
XMMC12-3/4S	12	3/4	£17.70
XMMC14-3/8S	14	3/8	£18.05
XMMC14-1/2S	14	1/2	£7.62
XMMC16-3/8S	16	3/8	£10.17
XMMC16-1/2S	16	1/2	£4.21
XMMC16-3/4S	16	3/4	£14.15
XMMC20-1/2S	20	1/2	£12.61
XMMC20-3/4S	20	3/4	£8.20
XMMC20-1S	20	1	£22.86
XMMC25-3/4S	25	3/4	£19.96
XMMC25-1S	25	1	£13.41
XMMC25-11/4S	25	1 1/4	£37.37
XMMC30-3/4S	30	3/4	£27.02
XMMC30-1S	30	1	£22.98
XMMC30-11/4S	30	1 1/4	£33.04
XMMC38-1S	38	1	£34.64
MMC38-11/4S	38	1 1/4	£26.93
MMC38-11/2S	38	1 1/2	£27.23

Male Stud Couplings Form B

Male Stud Coupling Form B

Male Thread BSPP
Metal to Metal Seal
Light Light Series



PGC: 234	OD (mm)	BSPP	Price
MMMC4-1/8LL-MM	4	1/8	£1.66
MMMC6-1/8LL-MM	6	1/8	£1.75
MMMC8-1/8LL-MM	8	1/8	£1.92

Male Stud Coupling Form B

Body Only
Male Thread BSPP
Metal to Metal Seal
Light Light Series



PGC: 234	OD (mm)	BSPP	Price
XMMC4-1/8LL-MM	4	1/8	£0.86
XMMC6-1/8LL-MM	6	1/8	£0.94
XMMC8-1/8LL-MM	8	1/8	£1.32

Light Series

PGC: 234	OD (mm)	BSPP	Price
MMMC6-1/8L-MM	6	1/8	£1.76
MMMC6-1/4L-MM	6	1/4	£2.56
MMMC6-3/8L-MM	6	3/8	£3.50
MMMC8-1/8L-MM	8	1/8	£3.59
MMMC8-1/4L-MM	8	1/4	£2.22
MMMC8-3/8L-MM	8	3/8	£3.19
MMMC8-1/2L-MM	8	1/2	£6.75
MMMC10-1/4L-MM	10	1/4	£1.76
MMMC10-3/8L-MM	10	3/8	£2.56
MMMC10-1/2L-MM	10	1/2	£3.50
MMMC12-1/4L-MM	12	1/4	£3.40
MMMC12-3/8L-MM	12	3/8	£3.59
MMMC12-1/2L-MM	12	1/2	£2.22
MMMC12-3/4L-MM	12	3/4	£9.52
MMMC15-3/8L-MM	15	3/8	£6.75
MMMC15-1/2L-MM	15	1/2	£4.43
MMMC15-3/4L-MM	15	3/4	£15.96
MMMC18-3/8L-MM	18	3/8	£11.59
MMMC18-1/2L-MM	18	1/2	£5.62
MMMC18-3/4L-MM	18	3/4	£10.41
MMMC22-1/2L-MM	22	1/2	£14.33
MMMC22-3/4L-MM	22	3/4	£8.21
MMMC22-1L-MM	22	1	£34.74
MMMC28-3/4L-MM	28	3/4	£33.83
MMMC28-1L-MM	28	1	£15.08
MMMC35-1L-MM	35	1	£43.38
MMMC35-1 1/4L-MM	35	1 1/4	£21.57
MMMC42-1 1/2L-MM	42	1 1/2	£25.63

Light Series

PGC: 234	OD (mm)	BSPP	Price
XMMC6-1/8L-MM	6	1/8	£0.94
XMMC6-1/4L-MM	6	1/4	£1.72
XMMC6-3/8L-MM	6	3/8	£2.67
XMMC8-1/8L-MM	8	1/8	£2.69
XMMC8-1/4L-MM	8	1/4	£1.32
XMMC8-3/8L-MM	8	3/8	£2.31
XMMC8-1/2L-MM	8	1/2	£5.85
XMMC10-1/4L-MM	10	1/4	£1.36
XMMC10-3/8L-MM	10	3/8	£2.10
XMMC10-1/2L-MM	10	1/2	£3.97
XMMC12-1/4L-MM	12	1/4	£2.16
XMMC12-3/8L-MM	12	3/8	£1.92
XMMC12-1/2L-MM	12	1/2	£3.38
XMMC12-3/4L-MM	12	3/4	£8.22
XMMC15-3/8L-MM	15	3/8	£3.73
XMMC15-1/2L-MM	15	1/2	£2.75
XMMC15-3/4L-MM	15	3/4	£14.17
XMMC18-3/8L-MM	18	3/8	£8.84
XMMC18-1/2L-MM	18	1/2	£2.86
XMMC18-3/4L-MM	18	3/4	£7.65
XMMC22-1/2L-MM	22	1/2	£10.60
XMMC22-3/4L-MM	22	3/4	£4.48
XMMC22-1L-MM	22	1	£31.01
XMMC28-3/4L-MM	28	3/4	£27.50
XMMC28-1L-MM	28	1	£8.76
XMMC35-1L-MM	35	1	£35.02
XMMC35-1 1/4L-MM	35	1 1/4	£13.21
XMMC42-1 1/2L-MM	42	1 1/2	£16.09

Heavy Series

PGC: 234	OD (mm)	BSPP	Price
MMMC6-1/4S-MM	6	1/4	£2.38
MMMC6-1/2S-MM	6	1/2	£15.30
MMMC8-1/4S-MM	8	1/4	£2.63
MMMC8-3/8S-MM	8	3/8	£6.43
MMMC10-1/4S-MM	10	1/4	£4.89
MMMC10-3/8S-MM	10	3/8	£3.42
MMMC10-1/2S-MM	10	1/2	£5.39
MMMC12-1/4S-MM	12	1/4	£6.47
MMMC12-3/8S-MM	12	3/8	£3.75
MMMC12-1/2S-MM	12	1/2	£4.48
MMMC12-3/4S-MM	12	3/4	£9.44
MMMC14-3/8S-MM	14	3/8	£3.75
MMMC14-1/2S-MM	14	1/2	£20.45
MMMC16-1/4S-MM	16	1/4	£21.36
MMMC16-3/8S-MM	16	3/8	£12.79
MMMC16-1/2S-MM	16	1/2	£6.29
MMMC16-3/4S-MM	16	3/4	£10.34
MMMC20-1/2S-MM	20	1/2	£16.27
MMMC20-3/4S-MM	20	3/4	£9.49
MMMC25-3/4S-MM	25	3/4	£24.95
MMMC25-1S-MM	25	1	£16.59
MMMC30-3/4S-MM	30	3/4	£29.71
MMMC30-1S-MM	30	1	£31.22
MMMC30-1 1/4S-MM	30	1 1/4	£25.35
MMMC38-1 1/4S-MM	38	1 1/4	£36.21
MMMC38-1 1/2S-MM	38	1 1/2	£31.12

Heavy Series

PGC: 234	OD (mm)	BSPP	Price
XMMC6-1/4S-MM	6	1/4	£1.49
XMMC6-1/2S-MM	6	1/2	£14.41
XMMC8-1/4S-MM	8	1/4	£1.66
XMMC8-3/8S-MM	8	3/8	£5.45
XMMC10-1/4S-MM	10	1/4	£3.66
XMMC10-3/8S-MM	10	3/8	£2.18
XMMC10-1/2S-MM	10	1/2	£4.05
XMMC12-1/4S-MM	12	1/4	£5.03
XMMC12-3/8S-MM	12	3/8	£2.32
XMMC12-1/2S-MM	12	1/2	£3.06
XMMC12-3/4S-MM	12	3/4	£8.22
XMMC14-3/8S-MM	14	3/8	£17.93
XMMC14-1/2S-MM	14	1/2	£4.18
XMMC16-1/4S-MM	16	1/4	£20.49
XMMC16-3/8S-MM	16	3/8	£9.89
XMMC16-1/2S-MM	16	1/2	£3.39
XMMC16-3/4S-MM	16	3/4	£7.44
XMMC20-1/2S-MM	20	1/2	£12.10
XMMC20-3/4S-MM	20	3/4	£5.34
XMMC25-3/4S-MM	25	3/4	£17.82
XMMC25-1S-MM	25	1	£9.44
XMMC30-3/4S-MM	30	3/4	£22.22
XMMC30-1S-MM	30	1	£22.22
XMMC30-1 1/4S-MM	30	1 1/4	£20.90
XMMC38-1 1/4S-MM	38	1 1/4	£23.66
XMMC38-1 1/2S-MM	38	1 1/2	£29.40



DIN 2353 Metric Steel Compression Fittings

Male Stud Coupling Form B

Male Thread Metric
Metal to Metal Seal
Light Light Series



PGC: 234	OD (mm)	Thread	Price
MMC4-M8LL-MM	4	M8 x 1	£1.71
MMC6-M10LL-MM	6	M10 x 1	£1.76
MMC8-M10LL-MM	8	M10 x 1	£1.99

Male Stud Coupling Form B

Body Only
Male Thread Metric
Metal to Metal Seal
Light Light Series



PGC: 234	OD (mm)	Thread	Price
XMMC4-M8LL-MM	4	M8 x 1	£0.91
XMMC6-M10LL-MM	6	M10 x 1	£1.00
XMMC8-M10LL-MM	8	M10 x 1	£1.15

Light Series

PGC: 234	OD (mm)	Thread	Price
MMC6-M10L-MM	6	M10 x 1	£1.76
MMC8-M10L-MM	8	M10 x 1	£2.15
MMC10-M10L-MM	10	M10 x 1	£2.41
MMC10-M16L-MM	10	M16 x 1.5	£4.66
MMC10-M18L-MM	10	M18 x 1.5	£6.47
MMC10-M22L-MM	10	M22 x 1.5	£12.14
MMC12-M14L-MM	12	M14 x 1.5	£8.97
MMC12-M16L-MM	12	M16 x 1.5	£3.20
MMC12-M18L-MM	12	M18 x 1.5	£5.76
MMC12-M22L-MM	12	M22 x 1.5	£6.82
MMC15-M16L-MM	15	M16 x 1.5	£9.69
MMC15-M18L-MM	15	M18 x 1.5	£3.96
MMC15-M22L-MM	15	M22 x 1.5	£7.04
MMC18-M18L-MM	18	M18 x 1.5	£6.28
MMC18-M22L-MM	18	M22 x 1.5	£5.71
MMC22-M22L-MM	22	M22 x 1.5	£26.75
MMC22-M26L-MM	22	M26 x 1.5	£8.48
MMC28-M33L-MM	28	M33 x 2	£14.83
MMC35-M42L-MM	35	M42 x 2	£21.38
MMC42-M48L-MM	42	M48 x 2	£21.38

Light Series

PGC: 234	OD (mm)	Thread	Price
XMMC6-M10L-MM	6	M10 x 1	£0.94
XMMC8-M10L-MM	8	M10 x 1	£1.25
XMMC10-M10L-MM	10	M10 x 1	£1.41
XMMC10-M16L-MM	10	M16 x 1.5	£3.65
XMMC10-M18L-MM	10	M18 x 1.5	£5.25
XMMC10-M22L-MM	10	M22 x 1.5	£11.03
XMMC12-M14L-MM	12	M14 x 1.5	£7.67
XMMC12-M16L-MM	12	M16 x 1.5	£2.57
XMMC12-M18L-MM	12	M18 x 1.5	£4.49
XMMC12-M22L-MM	12	M22 x 1.5	£5.23
XMMC15-M16L-MM	15	M16 x 1.5	£7.96
XMMC15-M18L-MM	15	M18 x 1.5	£2.18
XMMC15-M22L-MM	15	M22 x 1.5	£5.34
XMMC18-M18L-MM	18	M18 x 1.5	£3.52
XMMC18-M22L-MM	18	M22 x 1.5	£2.96
XMMC22-M22L-MM	22	M22 x 1.5	£23.02
XMMC22-M26L-MM	22	M26 x 1.5	£4.75
XMMC28-M33L-MM	28	M33 x 2	£8.51
XMMC35-M42L-MM	35	M42 x 2	£13.02
XMMC42-M48L-MM	42	M48 x 2	£16.68

Heavy Series

PGC: 234	OD (mm)	Thread	Price
MMC6-M12S-MM	6	M12 x 1.5	£2.41
MMC8-M14S-MM	8	M14 x 1.5	£2.66
MMC10-M16S-MM	10	M16 x 1.5	£2.66
MMC12-M18S-MM	12	M18 x 1.5	£3.98
MMC12-M22S-MM	12	M22 x 1.5	£23.93
MMC14-M20S-MM	14	M20 x 1.5	£6.82
MMC16-M18S-MM	16	M18 x 1.5	£12.23
MMC16-M22S-MM	18	M22 x 1.5	£6.29
MMC20-M27S-MM	20	M27 x 2	£9.57
MMC25-M33S-MM	25	M33 x 2	£16.42
MMC30-M42S-MM	30	M42 x 2	£25.04
MMC38-M48S-MM	38	M48 x 2	£31.12

Heavy Series

PGC: 234	OD (mm)	Thread	Price
XMMC6-M12S-MM	6	M12 x 1.5	£1.52
XMMC8-M14S-MM	8	M14 x 1.5	£1.69
XMMC10-M16S-MM	10	M16 x 1.5	£2.17
XMMC12-M18S-MM	12	M18 x 1.5	£2.31
XMMC12-M22S-MM	12	M22 x 1.5	£22.27
XMMC14-M20S-MM	14	M20 x 1.5	£4.45
XMMC16-M18S-MM	16	M18 x 1.5	£9.32
XMMC16-M22S-MM	18	M22 x 1.5	£3.39
XMMC20-M27S-MM	20	M27 x 2	£5.41
XMMC25-M33S-MM	25	M33 x 2	£9.29
XMMC30-M42S-MM	30	M42 x 2	£16.05
XMMC38-M48S-MM	38	M48 x 2	£18.58



VALE
THE GLOBAL SOURCE



Metric Steel Tube
Pages 128 - 129

RSB
Tube Clamps
Pages 131 - 142

Male Stud Couplings Form E

02

Male Stud Coupling Form E

Male Thread BSPP
WD Captive Seal
Light Series



PGC: 234	OD (mm)	BSPP	Price
MMC6-1/8L-WD	6	1/8	£2.23
MMC6-1/4L-WD	6	1/4	£3.08
MMC8-1/8L-WD	8	1/8	£3.96
MMC8-1/4L-WD	8	1/4	£2.77
MMC8-3/8L-WD	8	3/8	£3.71
MMC10-1/4L-WD	10	1/4	£2.93
MMC10-3/8L-WD	10	3/8	£3.66
MMC10-1/2L-WD	10	1/2	£5.60
MMC12-1/4L-WD	12	1/4	£3.93
MMC12-3/8L-WD	12	3/8	£3.69
MMC12-1/2L-WD	12	1/2	£5.27
MMC15-3/8L-WD	15	3/8	£5.89
MMC15-1/2L-WD	15	1/2	£5.04
MMC15-3/4L-WD	15	3/4	£16.45
MMC18-3/8L-WD	18	3/8	£12.07
MMC18-1/2L-WD	18	1/2	£6.26
MMC18-3/4L-WD	18	3/4	£10.99
MMC22-1/2L-WD	22	1/2	£14.72
MMC22-3/4L-WD	22	3/4	£8.83
MMC22-1L-WD	22	1	£34.30
MMC28-3/4L-WD	28	3/4	£33.48
MMC28-1L-WD	28	1	£16.34
MMC28-11/4L-WD	28	1 1/4	£64.39
MMC35-1L-WD	35	1	£43.36
MMC35-11/4L-WD	35	1 1/4	£22.94
MMC42-11/2L-WD	42	1 1/2	£27.42

Male Stud Coupling Form E

Body Only
Male Thread BSPP
WD Captive Seal
Light Series



PGC: 234	OD (mm)	BSPP	Price
XMMC6-1/8L-WD	6	1/8	£1.39
XMMC6-1/4L-WD	6	1/4	£2.25
XMMC8-1/8L-WD	8	1/8	£3.07
XMMC8-1/4L-WD	8	1/4	£1.88
XMMC8-3/8L-WD	8	3/8	£2.81
XMMC10-1/4L-WD	10	1/4	£2.88
XMMC10-3/8L-WD	10	3/8	£3.04
XMMC10-1/2L-WD	10	1/2	£4.59
XMMC12-1/4L-WD	12	1/4	£2.70
XMMC12-3/8L-WD	12	3/8	£2.45
XMMC12-1/2L-WD	12	1/2	£3.99
XMMC15-3/8L-WD	15	3/8	£4.20
XMMC15-1/2L-WD	15	1/2	£3.92
XMMC15-3/4L-WD	15	3/4	£14.65
XMMC18-3/8L-WD	18	3/8	£9.32
XMMC18-1/2L-WD	18	1/2	£3.50
XMMC18-3/4L-WD	18	3/4	£8.13
XMMC22-1/2L-WD	22	1/2	£10.99
XMMC22-3/4L-WD	22	3/4	£5.11
XMMC22-1L-WD	22	1	£30.58
XMMC28-3/4L-WD	28	3/4	£27.15
XMMC28-1L-WD	28	1	£9.85
XMMC28-11/4L-WD	28	1 1/4	£10.23
XMMC35-1L-WD	35	1	£35.00
XMMC35-11/4L-WD	35	1 1/4	£14.58
XMMC42-11/2L-WD	42	1 1/2	£17.89

Heavy Series

PGC: 234	OD (mm)	BSPP	Price
MMC6-1/4S-WD	6	1/4	£2.93
MMC8-1/4S-WD	8	1/4	£3.17
MMC8-3/8S-WD	8	3/8	£6.81
MMC10-1/4S-WD	10	1/4	£5.36
MMC10-3/8S-WD	10	3/8	£3.95
MMC10-1/2S-WD	10	1/2	£5.89
MMC12-1/4S-WD	12	1/4	£6.93
MMC12-3/8S-WD	12	3/8	£4.27
MMC12-1/2S-WD	12	1/2	£5.13
MMC14-3/8S-WD	14	3/8	£21.77
MMC14-1/2S-WD	14	1/2	£7.15
MMC16-3/8S-WD	16	3/8	£13.01
MMC16-1/2S-WD	16	1/2	£6.86
MMC16-3/4S-WD	16	3/4	£10.84
MMC20-1/2S-WD	20	1/2	£16.55
MMC20-3/4S-WD	20	3/4	£9.98
MMC25-1/2S-WD	25	1/2	£42.68
MMC25-3/4S-WD	25	3/4	£25.02
MMC25-1S-WD	25	1	£17.43
MMC30-1S-WD	30	1	£31.75
MMC30-11/4S-WD	30	1 1/4	£26.28
MMC38-11/4S-WD	38	1 1/4	£37.19
MMC38-11/2S-WD	38	1 1/2	£32.82

Heavy Series

PGC: 234	OD (mm)	BSPP	Price
XMMC6-1/4S-WD	6	1/4	£2.05
XMMC8-1/4S-WD	8	1/4	£2.20
XMMC8-3/8S-WD	8	3/8	£5.85
XMMC10-1/4S-WD	10	1/4	£4.13
XMMC10-3/8S-WD	10	3/8	£2.72
XMMC10-1/2S-WD	10	1/2	£4.65
XMMC12-1/4S-WD	12	1/4	£5.44
XMMC12-3/8S-WD	12	3/8	£2.84
XMMC12-1/2S-WD	12	1/2	£3.70
XMMC14-3/8S-WD	14	3/8	£17.80
XMMC14-1/2S-WD	14	1/2	£4.76
XMMC16-3/8S-WD	16	3/8	£10.10
XMMC16-1/2S-WD	16	1/2	£3.95
XMMC16-3/4S-WD	16	3/4	£7.94
XMMC20-1/2S-WD	20	1/2	£12.38
XMMC20-3/4S-WD	20	3/4	£5.81
XMMC25-1/2S-WD	25	1/2	£35.54
XMMC25-3/4S-WD	25	3/4	£17.88
XMMC25-1S-WD	25	1	£10.30
XMMC30-1S-WD	30	1	£22.75
XMMC30-11/4S-WD	30	1 1/4	£22.22
XMMC38-11/4S-WD	38	1 1/4	£24.65
XMMC38-11/2S-WD	38	1 1/2	£20.28



DIN 2353 Metric Steel Compression Fittings

Male Stud Coupling Form E

Male Thread Metric
WD Captive Seal
Light Series



PGC: 234	OD (mm)	Thread	Price
MMC6-M10L-WD	6	M10 x 1	£2.25
MMC8-M12L-WD	8	M12 x 1.5	£2.67
MMC10-M14L-WD	10	M14 x 1.5	£2.98
MMC10-M16L-WD	10	M16 x 1.5	£5.16
MMC10-M18L-WD	10	M18 x 1.5	£6.79
MMC12-M16L-WD	12	M16 x 1.5	£3.75
MMC12-M18L-WD	12	M18 x 1.5	£6.27
MMC12-M22L-WD	12	M22 x 1.5	£7.56
MMC15-M22L-WD	15	M22 x 1.5	£11.00
MMC18-M22L-WD	18	M22 x 1.5	£6.35
MMC22-M26L-WD	22	M26 x 1.5	£9.07
MMC28-M33L-WD	28	M33 x 2	£15.91
MMC35-M42L-WD	35	M42 x 2	£22.78
MMC42-M48L-WD	42	M48 x 2	£28.40

Male Stud Coupling Form E

Body Only
Male Thread Metric
WD Captive Seal
Light Series



PGC: 234	OD (mm)	Thread	Price
XMMC6-M10L-WD	6	M10 x 1	£1.41
XMMC8-M12L-WD	8	M12 x 1.5	£1.76
XMMC10-M14L-WD	10	M14 x 1.5	£1.96
XMMC10-M16L-WD	10	M16 x 1.5	£4.12
XMMC10-M18L-WD	10	M18 x 1.5	£5.75
XMMC12-M16L-WD	12	M16 x 1.5	£2.49
XMMC12-M18L-WD	12	M18 x 1.5	£4.99
XMMC12-M22L-WD	12	M22 x 1.5	£5.76
XMMC15-M22L-WD	15	M22 x 1.5	£2.79
XMMC18-M22L-WD	18	M22 x 1.5	£3.59
XMMC22-M26L-WD	22	M26 x 1.5	£5.36
XMMC28-M33L-WD	28	M33 x 2	£9.59
XMMC35-M42L-WD	35	M42 x 2	£14.42
XMMC42-M48L-WD	42	M48 x 2	£18.86

Heavy Series

PGC: 234	OD (mm)	Thread	Price
MMC6-M12S-WD	6	M12 x 1.5	£2.88
MMC8-M14S-WD	8	M14 x 1.5	£3.19
MMC10-M16S-WD	10	M16 x 1.5	£4.06
MMC12-M18S-WD	12	M18 x 1.5	£4.36
MMC14-M20S-WD	14	M20 x 1.5	£7.80
MMC20-M27S-WD	20	M27 x 2	£10.15
MMC25-M33S-WD	25	M33 x 2	£17.51
MMC30-M42S-WD	30	M42 x 2	£26.35
MMC38-M48S-WD	38	M48 x 2	£32.82

Heavy Series

PGC: 234	OD (mm)	Thread	Price
XMMC6-M12S-WD	6	M12 x 1.5	£1.99
XMMC8-M14S-WD	8	M14 x 1.5	£2.23
XMMC10-M16S-WD	10	M16 x 1.5	£2.71
XMMC12-M18S-WD	12	M18 x 1.5	£2.90
XMMC14-M20S-WD	14	M20 x 1.5	£4.99
XMMC20-M27S-WD	20	M27 x 2	£5.81
XMMC25-M33S-WD	25	M33 x 2	£10.36
XMMC30-M42S-WD	30	M42 x 2	£17.35
XMMC38-M48S-WD	38	M48 x 2	£20.67

Adjustable Run Tees - DKO Type

Adjustable Run Tee

DKO Type
Light Series



PGC: 234	OD (mm)	Thread	Price
MSRT6L-DKO	6	M12 x 1.5	£12.37
MSRT8L-DKO	8	M14 x 1.5	£12.47
MSRT10L-DKO	10	M16 x 1.5	£13.68
MSRT12L-DKO	12	M18 x 1.5	£15.34
MSRT15L-DKO	15	M22 x 1.5	£19.96
MSRT18L-DKO	18	M26 x 1.5	£27.19
MSRT22L-DKO	22	M30 x 2	£39.73
MSRT28L-DKO	28	M36 x 2	£60.03
MSRT35L-DKO	35	M45 x 2	£81.41
MSRT42L-DKO	42	M52 x 2	£120.59

Adjustable Branch Tees - DKO Type

Adjustable Branch Tee

DKO Type
Light Series



PGC: 234	OD (mm)	Thread	Price
MSBT6L-DKO	6	M12 x 1.5	£12.07
MSBT8L-DKO	8	M14 x 1.5	£12.57
MSBT10L-DKO	10	M16 x 1.5	£14.22
MSBT12L-DKO	12	M18 x 1.5	£14.84
MSBT15L-DKO	15	M22 x 1.5	£19.48
MSBT18L-DKO	18	M26 x 1.5	£26.32
MSBT22L-DKO	22	M30 x 2	£40.68
MSBT28L-DKO	28	M36 x 2	£60.39
MSBT35L-DKO	35	M45 x 2	£80.03
MSBT42L-DKO	42	M52 x 2	£120.93

Heavy Series

PGC: 234	OD (mm)	Thread	Price
MSRT6S-DKO	6	M14 x 1.5	£13.98
MSRT8S-DKO	8	M16 x 1.5	£13.95
MSRT10S-DKO	10	M18 x 1.5	£17.30
MSRT12S-DKO	12	M20 x 1.5	£19.12
MSRT14S-DKO	14	M22 x 1.5	£29.31
MSRT16S-DKO	16	M24 x 1.5	£29.60
MSRT20S-DKO	20	M30 x 2	£43.05
MSRT25S-DKO	25	M36 x 2	£65.09
MSRT30S-DKO	30	M42 x 2	£83.63
MSRT38S-DKO	38	M52 x 2	£133.34

Heavy Series

PGC: 234	OD (mm)	Thread	Price
MSBT6S-DKO	6	M14 x 1.5	£13.75
MSBT8S-DKO	8	M16 x 1.5	£15.16
MSBT10S-DKO	10	M18 x 1.5	£16.74
MSBT12S-DKO	12	M20 x 1.5	£18.92
MSBT14S-DKO	14	M22 x 1.5	£57.16
MSBT16S-DKO	16	M24 x 1.5	£27.53
MSBT20S-DKO	20	M30 x 2	£43.30
MSBT25S-DKO	25	M36 x 2	£64.58
MSBT30S-DKO	30	M42 x 2	£82.02
MSBT38S-DKO	38	M52 x 2	£130.19



Adjustable Tees

Adjustable Branch Tee

Light Series



PGC: 234	OD (mm)	Thread	Price
MSBT6L	6	M12 x 1.5	£10.34
MSBT8L	8	M14 x 1.5	£10.75
MSBT10L	10	M16 x 1.5	£12.39
MSBT12L	12	M18 x 1.5	£12.94
MSBT15L	15	M22 x 1.5	£17.25
MSBT18L	18	M26 x 2	£23.45
MSBT22L	22	M30 x 2	£37.53
MSBT28L	28	M36 x 2	£55.89
MSBT35L	35	M45 x 2	£75.42
MSBT42L	42	M52 x 2	£102.63

Adjustable Elbows

Adjustable Elbow 90°

Light Series



PGC: 234	OD (mm)	Thread	Price
MSE6L	6	M12 x 1.5	£7.25
MSE8L	8	M14 x 1.5	£6.88
MSE10L	10	M16 x 1.5	£12.03
MSE12L	12	M18 x 1.5	£13.60
MSE15L	15	M22 x 1.5	£17.74
MSE18L	18	M26 x 2	£24.61
MSE22L	22	M30 x 2	£36.26
MSE28L	28	M36 x 2	£56.47
MSE35L	35	M45 x 2	£76.82
MSE42L	42	M52 x 2	£101.88

Adjustable Elbow 90°

DKO Type
Light Series



PGC: 234	OD (mm)	Thread	Price
MSE6L-DKO	6	M12 x 1.5	£7.54
MSE8L-DKO	8	M14 x 1.5	£7.55
MSE10L-DKO	10	M16 x 1.5	£8.29
MSE12L-DKO	12	M18 x 1.5	£11.31
MSE15L-DKO	15	M22 x 1.5	£11.74
MSE18L-DKO	18	M26 x 2	£16.81
MSE22L-DKO	22	M30 x 2	£22.99
MSE28L-DKO	28	M36 x 2	£35.44
MSE35L-DKO	35	M45 x 2	£52.03
MSE42L-DKO	42	M52 x 2	£74.58

Heavy Series

PGC: 234	OD (mm)	Thread	Price
MSBT6S	6	M14 x 1.5	£11.78
MSBT8S	8	M16 x 1.5	£12.83
MSBT10S	10	M18 x 1.5	£14.52
MSBT12S	12	M20 x 1.5	£16.61
MSBT14S	14	M22 x 1.5	£25.64
MSBT16S	16	M24 x 1.5	£24.27
MSBT20S	20	M30 x 2	£39.69
MSBT25S	25	M36 x 2	£59.45
MSBT30S	30	M42 x 2	£77.52
MSBT38S	38	M52 x 2	£114.22

Heavy Series

PGC: 234	OD (mm)	Thread	Price
MSE6S	6	M14 x 1.5	£7.67
MSE8S	8	M16 x 1.5	£8.58
MSE10S	10	M18 x 1.5	£15.03
MSE12S	12	M20 x 1.5	£16.88
MSE14S	14	M22 x 1.5	£26.37
MSE16S	16	M24 x 1.5	£26.35
MSE20S	20	M30 x 2	£39.37
MSE25S	25	M36 x 2	£59.93
MSE30S	30	M42 x 2	£79.17
MSE38S	38	M52 x 2	£115.71

Heavy Series

PGC: 234	OD (mm)	Thread	Price
MSE6S-DKO	6	M14 x 1.5	£8.59
MSE8S-DKO	8	M16 x 1.5	£9.46
MSE10S-DKO	10	M18 x 1.5	£10.83
MSE12S-DKO	12	M20 x 1.5	£11.25
MSE14S-DKO	14	M22 x 1.5	£16.34
MSE16S-DKO	16	M24 x 1.5	£17.37
MSE20S-DKO	20	M30 x 2	£24.76
MSE25S-DKO	25	M36 x 2	£37.75
MSE30S-DKO	30	M42 x 2	£52.96
MSE38S-DKO	38	M52 x 2	£80.32

Adjustable Run Tee

Light Series



PGC: 234	OD (mm)	Thread	Price
MSRT6L	6	M12 x 1.5	£10.33
MSRT8L	8	M14 x 1.5	£10.74
MSRT10L	10	M16 x 1.5	£12.03
MSRT12L	12	M18 x 1.5	£13.60
MSRT15L	15	M22 x 1.5	£17.74
MSRT18L	18	M26 x 1.5	£24.61
MSRT22L	22	M30 x 2	£36.26
MSRT28L	28	M36 x 2	£56.47
MSRT35L	35	M45 x 2	£76.82
MSRT42L	42	M52 x 2	£101.88

Adjustable Elbows

Adjustable Elbow 45°

DKO Type
Light Series



PGC: 234	OD (mm)	Thread	Price
MS45E6L-DKO	6	M14 x 1.5	£26.51
MS45E8L-DKO	8	M16 x 1.5	£26.69
MS45E10L-DKO	10	M18 x 1.5	£31.50
MS45E12L-DKO	12	M20 x 1.5	£29.83
MS45E15L-DKO	15	M22 x 1.5	£31.01
MS45E18L-DKO	18	M24 x 1.5	£35.50
MS45E22L-DKO	22	M30 x 2	£44.38
MS45E28L-DKO	28	M36 x 2	£55.84
MS45E35L-DKO	35	M45 x 2	£99.52
MS45E42L-DKO	42	M52 x 2	£106.99

Allen Head Key Plugs

Allen Head Key Plug

BSPB



PGC: 234	BSPB	Price
AKP1/8	1/8	£1.77
AKP1/4	1/4	£1.97
AKP3/8	3/8	£2.28
AKP1/2	1/2	£3.16
AKP3/4	3/4	£4.24
AKP1	1	£7.98
AKP11/4	1 1/4	£13.51
AKP11/2	1 1/2	£15.78

Heavy Series

PGC: 234	OD (mm)	Thread	Price
MSRT6S	6	M14 x 1.5	£11.92
MSRT8S	8	M16 x 1.5	£13.23
MSRT10S	10	M18 x 1.5	£15.03
MSRT12S	12	M20 x 1.5	£16.88
MSRT14S	14	M22 x 1.5	£26.37
MSRT16S	16	M24 x 1.5	£26.35
MSRT20S	20	M30 x 2	£39.37
MSRT25S	25	M36 x 2	£59.93
MSRT30S	30	M42 x 2	£79.17
MSRT38S	38	M52 x 2	£115.71

Heavy Series

PGC: 234	OD (mm)	Thread	Price
MS45E6S-DKO	6	M14 x 1.5	£32.92
MS45E8S-DKO	8	M16 x 1.5	£46.98
MS45E10S-DKO	10	M18 x 1.5	£33.47
MS45E12S-DKO	12	M20 x 1.5	£33.73
MS45E16S-DKO	16	M24 x 1.5	£36.26
MS45E20S-DKO	20	M30 x 2	£46.97
MS45E25S-DKO	25	M36 x 2	£58.36
MS45E30S-DKO	30	M42 x 2	£101.63
MS45E38S-DKO	38	M52 x 2	£114.08

Metric

PGC: 234	Thread	Price
AKPM8	M8 x 1	£2.36
AKPM10	M10 x 1	£2.17
AKPM12	M12 x 1.5	£2.89
AKPM14	M14 x 1.5	£3.12
AKPM16	M16 x 1.5	£3.74
AKPM18	M18 x 1.5	£3.62
AKPM20	M20 x 1.5	£5.03
AKPM22	M22 x 1.5	£4.65
AKPM26	M26 x 1.5	£6.96
AKPM27	M27 x 2	£6.17
AKPM33	M33 x 2	£8.17
AKPM42	M42 x 2	£11.79
AKPM48	M48 x 2	£16.21



DIN 2353 Metric Steel Compression Fittings

Tube Benders

Tube Bender

PGC: 234	OD (mm)	Price
MTB6-18	6-18	£378.06
MTB20-25	20-25	£968.78

Reducing Couplings

Reducing Female Swivel Coupling

PGC: 234	Thread A	Thread B	Price
MSFC6L-6S	M12 x 1.5	M14 x 1.5	£22.61
MSFC6L-8L	M12 x 1.5	M14 x 1.5	£16.50
MSFC6L-8S	M12 x 1.5	M16 x 1.5	£16.48
MSFC6L-10L	M12 x 1.5	M16 x 1.5	£19.93
MSFC6L-10S	M12 x 1.5	M18 x 1.5	£19.92
MSFC8L-8S	M14 x 1.5	M16 x 1.5	£23.93
MSFC8L-10L	M14 x 1.5	M16 x 1.5	£16.78
MSFC8L-10S	M14 x 1.5	M18 x 1.5	£16.77
MSFC8L-12L	M14 x 1.5	M18 x 1.5	£19.29
MSFC8L-12S	M14 x 1.5	M20 x 1.5	£19.29
MSFC10L-12L	M16 x 1.5	M18 x 1.5	£17.01
MSFC10L-12S	M16 x 1.5	M20 x 1.5	£17.01
MSFC10L-14S	M16 x 1.5	M22 x 1.5	£22.57
MSFC10L-15L	M16 x 1.5	M22 x 1.5	£22.56
MSFC10L-16S	M16 x 1.5	M24 x 1.5	£27.10
MSFC10S-10L	M18 x 1.5	M16 x 1.5	£25.28
MSFC10S-12L	M18 x 1.5	M18 x 1.5	£22.07
MSFC10S-12S	M18 x 1.5	M20 x 1.5	£17.01
MSFC12L-14S	M18 x 1.5	M22 x 1.5	£23.63
MSFC12L-15L	M18 x 1.5	M22 x 1.5	£20.31
MSFC12L-16S	M18 x 1.5	M24 x 1.5	£25.23
MSFC12L-18L	M18 x 1.5	M26 x 1.5	£24.10
MSFC12L-20S	M18 x 1.5	M30 x 2	£28.60
MSFC12S-12L	M20 x 1.5	M18 x 1.5	£26.41
MSFC12S-14S	M20 x 1.5	M22 x 1.5	£25.43
MSFC12S-15L	M20 x 1.5	M22 x 1.5	£20.29
MSFC12S-16S	M20 x 1.5	M24 x 1.5	£25.23
MSFC12S-18L	M20 x 1.5	M26 x 1.5	£24.10
MSFC14S-16S	M22 x 1.5	M24 x 1.5	£24.21
MSFC15L-16S	M22 x 1.5	M24 x 1.5	£26.20
MSFC15L-18L	M22 x 1.5	M26 x 1.5	£21.39
MSFC15L-20S	M22 x 1.5	M30 x 2	£26.67
MSFC15L-22L	M22 x 1.5	M30 x 2	£28.48
MSFC15L-25S	M22 x 1.5	M36 x 2	£35.03
MSFC16S-18L	M24 x 1.5	M26 x 1.5	£28.31
MSFC16S-20S	M24 x 1.5	M30 x 2	£26.54
MSFC16S-22L	M24 x 1.5	M30 x 2	£32.36
MSFC16S-25S	M24 x 1.5	M36 x 2	£31.64
MSFC18L-20S	M26 x 1.5	M30 x 2	£29.65
MSFC18L-22L	M26 x 1.5	M30 x 2	£25.93
MSFC18L-25S	M26 x 1.5	M36 x 2	£37.76
MSFC18L-28L	M26 x 1.5	M36 x 2	£33.11
MSFC18L-30S	M26 x 1.5	M42 x 2	£44.67
MSFC20S-22L	M30 x 2	M30 x 2	£31.87
MSFC20S-25S	M30 x 2	M36 x 2	£28.69
MSFC20S-28L	M30 x 2	M36 x 2	£39.99
MSFC20S-30S	M30 x 2	M42 x 2	£44.63
MSFC22L-25S	M30 x 2	M36 x 2	£38.52
MSFC22L-28L	M30 x 2	M36 x 2	£29.60
MSFC22L-30S	M30 x 2	M42 x 2	£47.01
MSFC22L-35L	M30 x 2	M45 x 2	£45.59
MSFC22L-38S	M30 x 2	M52 x 2	£55.30
MSFC25S-28L	M36 x 2	M36 x 2	£42.00
MSFC25S-30S	M36 x 2	M42 x 2	£40.77
MSFC25S-35L	M36 x 2	M45 x 2	£52.63
MSFC25S-38S	M36 x 2	M52 x 2	£59.41
MSFC28L-30S	M36 x 2	M42 x 2	£55.19
MSFC28L-35L	M36 x 2	M45 x 2	£43.13
MSFC28L-38S	M36 x 2	M52 x 2	£50.06
MSFC28L-42L	M36 x 2	M52 x 2	£56.53
MSFC30S-35L	M42 x 2	M45 x 2	£58.68
MSFC30S-38S	M42 x 2	M52 x 2	£56.80
MSFC30S-42L	M42 x 2	M52 x 2	£60.62
MSFC35L-38S	M45 x 2	M52 x 2	£69.43
MSFC35L-42L	M45 x 2	M52 x 2	£55.19
MSFC38S-42L	M52 x 2	M52 x 2	£71.71

Swivel Couplings & Gauge Connectors

Female Swivel Coupling
Light Series

PGC: 234	Thread	Price
MSFC6L	M12 x 1.5	£10.86
MSFC8L	M14 x 1.5	£11.68
MSFC10L	M16 x 1.5	£12.10
MSFC12L	M18 x 1.5	£12.98
MSFC15L	M22 x 1.5	£14.53
MSFC18L	M26 x 2	£15.98
MSFC22L	M30 x 2	£18.44
MSFC28L	M36 x 2	£27.37
MSFC35L	M45 x 2	£32.39
MSFC42L	M52 x 2	£39.32

Heavy Series

PGC: 234	Thread	Price
MSFC6S	M14 x 1.5	£13.07
MSFC8S	M16 x 1.5	£14.02
MSFC10S	M18 x 1.5	£14.39
MSFC12S	M20 x 1.5	£15.71
MSFC14S	M22 x 1.5	£19.48
MSFC16S	M24 x 1.5	£18.27
MSFC20S	M30 x 1.5	£21.35
MSFC25S	M36 x 2	£27.34
MSFC30S	M42 x 2	£39.98
MSFC38S	M52 x 2	£44.90

Female Gauge Connector
Female Thread BSPP
Light Series

PGC: 234	OD (mm)	BSPP	Price
MFGC6-1/4L	6	1/4	£4.43
MFGC8-1/4L	8	1/4	£4.47
MFGC10-1/4L	10	1/4	£4.97
MFGC12-1/4L	12	1/4	£5.27

Heavy Series

PGC: 234	OD (mm)	BSPP	Price
MFGC6-1/2S	6	1/2	£7.77
MFGC8-1/2S	8	1/2	£7.96
MFGC10-1/2S	10	1/2	£8.96
MFGC12-1/2S	12	1/2	£8.60

Swivel Tube Reducing Coupling

Light Series



PGC: 234	OD (mm)	Thread	Price
MRA8-6L	6	M14 x 1.5	£5.02
MRA10-6L	6	M16 x 1.5	£5.24
MRA10-8L	8	M16 x 1.5	£5.31
MRA12-6L	6	M18 x 1.5	£5.55
MRA12-8L	8	M18 x 1.5	£5.62
MRA12-10L	10	M18 x 1.5	£5.73
MRA15-6L	6	M22 x 1.5	£6.46
MRA15-8L	8	M22 x 1.5	£6.23
MRA15-10L	10	M22 x 1.5	£6.35
MRA15-12L	12	M22 x 1.5	£6.56
MRA18-6L	6	M26 x 1.5	£12.85
MRA18-8L	8	M26 x 1.5	£8.05
MRA18-10L	10	M26 x 1.5	£8.09
MRA18-12L	12	M26 x 1.5	£8.30
MRA18-15L	15	M26 x 1.5	£8.72
MRA22-6L	6	M30 x 2	£16.49
MRA22-8L	8	M30 x 2	£14.85
MRA22-10L	10	M30 x 2	£13.92
MRA22-12L	12	M30 x 2	£10.41
MRA22-15L	15	M30 x 2	£10.82
MRA22-18L	18	M30 x 2	£11.93
MRA28-6L	6	M36 x 2	£16.49
MRA28-8L	8	M36 x 2	£24.14
MRA28-10L	10	M36 x 2	£20.09
MRA28-12L	12	M36 x 2	£18.91
MRA28-15L	15	M36 x 2	£18.84
MRA28-18L	18	M36 x 2	£19.94
MRA28-22L	22	M36 x 2	£20.91
MRA35-15L	15	M45 x 2	£34.66
MRA35-18L	18	M45 x 2	£29.84
MRA35-22L	22	M45 x 2	£27.70
MRA35-28L	28	M45 x 2	£29.50
MRA42-18L	18	M52 x 2	£53.60
MRA42-22L	22	M52 x 2	£35.85
MRA42-28L	28	M52 x 2	£36.59
MRA42-35L	35	M52 x 2	£41.41

Reducing Coupling

Light Series



PGC: 234	OD 1 (mm)	OD 2 (mm)	Price
MRC8-6L	8	6	£5.43
MRC10-6L	10	6	£5.98
MRC10-8L	10	8	£6.16
MRC12-6L	12	6	£6.77
MRC12-8L	12	8	£6.90
MRC12-10L	12	10	£7.12
MRC15-10L	15	10	£8.85
MRC15-12L	15	12	£9.07
MRC18-10L	18	10	£14.22
MRC18-12L	18	12	£12.38
MRC18-15L	18	15	£12.98
MRC22-12L	22	12	£19.77
MRC22-15L	22	15	£16.24
MRC22-18L	22	18	£17.49
MRC28-18L	28	18	£32.87
MRC28-22L	28	22	£33.21
MRC35-22L	35	22	£43.68
MRA35-28L	35	28	£47.11

Heavy Series

PGC: 234	OD (mm)	Thread	Price
MRA8-6S	6	M16 x 1.5	£10.95
MRA10-6S	6	M18 x 1.5	£7.29
MRA10-8S	8	M18 x 1.5	£7.38
MRA12-6S	6	M20 x 1.5	£6.35
MRA12-8S	8	M20 x 1.5	£6.43
MRA12-10S	10	M20 x 1.5	£6.69
MRA14-6S	6	M22 x 1.5	£17.33
MRA14-8S	8	M22 x 1.5	£16.85
MRA14-10S	10	M22 x 1.5	£17.12
MRA14-12S	12	M22 x 1.5	£17.36
MRA16-6S	6	M24 x 1.5	£11.88
MRA16-8S	8	M24 x 1.5	£8.61
MRA16-10S	10	M24 x 1.5	£8.88
MRA16-12S	12	M24 x 1.5	£9.07
MRA16-14S	14	M24 x 1.5	£20.18
MRA20-6S	6	M30 x 2	£15.89
MRA20-8S	8	M36 x 2	£14.81
MRA20-10S	10	M30 x 2	£12.98
MRA20-12S	12	M30 x 2	£11.30
MRA20-14S	14	M30 x 2	£27.38
MRA20-16S	16	M30 x 2	£12.77
MRA25-6S	6	M36 x 2	£26.21
MRA25-8S	8	M36 x 2	£25.79
MRA25-10S	10	M36 x 2	£23.94
MRA25-12S	12	M36 x 2	£19.34
MRA25-14S	14	M36 x 2	£40.78
MRA25-16S	16	M36 x 2	£19.74
MRA25-20S	20	M36 x 2	£21.73
MRA30-8S	8	M42 x 2	£31.40
MRA30-10S	10	M42 x 2	£29.50
MRA30-12S	12	M42 x 2	£25.26
MRA30-16S	16	M42 x 2	£25.61
MRA30-20S	20	M42 x 2	£30.47
MRA30-25S	25	M42 x 2	£30.47
MRA38-12S	12	M52 x 2	£48.70
MRA38-16S	16	M52 x 2	£42.01
MRA38-20S	20	M52 x 2	£40.46
MRA38-25S	25	M52 x 2	£43.45
MRA38-30S	30	M52 x 2	£45.30

Heavy Series

PGC: 234	OD 1 (mm)	OD 2 (mm)	Price
MRC8-6S	8	6	£7.61
MRC10-6S	10	6	£11.60
MRC10-8S	10	8	£9.59
MRC12-6S	12	6	£9.77
MRC12-8S	12	8	£9.83
MRC12-10S	12	10	£10.20
MRC14-10S	14	10	£18.62
MRC14-12S	14	12	£18.31
MRC16-12S	16	12	£13.48
MRA16-14S	16	14	£19.29
MRC20-10S	20	10	£18.29
MRC20-12S	20	12	£18.91
MRC20-16S	20	16	£19.61
MRC25-16S	25	16	£35.16
MRA25-20S	25	20	£34.78
MRC30-20S	30	20	£46.72
MRC30-25S	30	25	£49.82
MRC38-30S	38	30	£69.79



DIN 2353 Metric Steel Compression Fittings

02

Positionable Elbows

Positionable Elbow 90°

Male Thread BSPP
O-Ring Seal
Light Series



PGC: 234	OD (mm)	BSPP	Price
MPE6-1/8L-OR	6	1/8	£11.40
MPE8-1/4L-OR	8	1/4	£11.88
MPE10-1/4L-OR	10	1/4	£12.81
MPE12-3/8L-OR	12	3/8	£14.29
MPE15-1/2L-OR	15	1/2	£17.03
MPE18-1/2L-OR	18	1/2	£19.72
MPE22-3/4L-OR	22	3/4	£23.84
MPE28-1L-OR	28	1	£43.87
MPE35-11/4L-OR	35	1 1/4	£78.90
MPE42-11/2L-OR	42	1 1/2	£88.29

Positionable Elbow 45°

Male Thread BSPP
O-Ring Seal
Light Series



PGC: 234	OD (mm)	BSPP	Price
MP45E8-1/4L-OR	8	1/4	£27.96
MP45E10-1/4L-OR	10	1/4	£29.10
MP45E12-3/8L-OR	12	3/8	£28.29
MP45E15-1/2L-OR	15	1/2	£28.48
MP45E18-1/2L-OR	18	1/2	£37.77
MP45E22-3/4L-OR	22	3/4	£52.55
MP45E28-1L-OR	28	1	£79.69
MP45E35-11/4L-OR	35	1 1/4	£151.56
MP45E42-11/2L-OR	42	1 1/2	£142.41

Heavy Series

PGC: 234	OD (mm)	BSPP	Price
MPE6-1/4S-OR	6	1/4	£32.38
MPE8-1/4S-OR	8	1/4	£12.77
MPE10-3/8S-OR	10	3/8	£14.29
MPE12-3/8S-OR	12	3/8	£15.25
MPE16-1/2S-OR	16	1/2	£19.88
MPE20-3/4S-OR	20	3/4	£24.18
MPE25-1S-OR	25	1	£44.68
MPE30-11/4S-OR	30	1 1/4	£79.54
MPE38-11/2S-OR	38	1 1/2	£91.30

Heavy Series

PGC: 234	OD (mm)	BSPP	Price
MP45E6-1/4S-OR	6	1/4	£78.50
MP45E8-1/4S-OR	8	1/4	£29.05
MP45E10-3/8S-OR	10	3/8	£28.29
MP45E12-3/8S-OR	12	3/8	£29.60
MP45E16-1/2S-OR	16	1/2	£37.92
MP45E20-3/4S-OR	20	3/4	£52.98
MP45E25-1S-OR	25	1	£80.52
MP45E30-11/4S-OR	30	1 1/4	£152.21
MP45E38-11/2S-OR	38	1 1/2	£145.43

Positionable Elbow 90°

Male Thread Metric
O-Ring Seal
Light Series



PGC: 234	OD (mm)	Thread	Price
MPE6-M10L-OR	6	M10 x 1	£29.18
MPE8-M12L-OR	8	M12 x 1.5	£90.93
MPE10-M14L-OR	10	M14 x 1.5	£11.43
MPE12-M16L-OR	12	M16 x 1.5	£13.51
MPE15-M18L-OR	15	M18 x 1.5	£18.02
MPE18-M22L-OR	18	M22 x 1.5	£19.72
MPE22-M27L-OR	22	M27 x 2	£23.94
MPE28-M33L-OR	28	M33 x 2	£43.67
MPE35-M42L-OR	35	M42 x 2	£85.28
MPE42-M48L-OR	42	M48 x 2	£94.88

Positionable Elbow 45°

Male Thread Metric
O-Ring Seal
Light Series



PGC: 234	OD (mm)	Thread	Price
MP45E6-M10L-OR	6	M10 x 1	£65.38
MP45E8-M12L-OR	8	M12 x 1.5	£78.64
MP45E10-M14L-OR	10	M14 x 1.5	£24.33
MP45E12-M16L-OR	12	M16 x 1.5	£24.85
MP45E15-M18L-OR	15	M18 x 1.5	£29.10
MP45E18-M22L-OR	18	M22 x 1.5	£35.66
MP45E22-M27L-OR	22	M27 x 2	£50.05
MP45E28-M33L-OR	28	M33 x 2	£78.37
MP45E35-M42L-OR	35	M42 x 2	£148.15
MP45E38-M48L-OR	38	M48 x 2	£135.56

Heavy Series

PGC: 234	OD (mm)	Thread	Price
MPE6-M12S-OR	6	M12 x 1.5	£12.34
MPE8-M14S-OR	8	M14 x 1.5	£11.37
MPE10-M16S-OR	10	M16 x 1.5	£13.51
MPE12-M18S-OR	12	M18 x 1.5	£18.10
MPE16-M22S-OR	16	M22 x 1.5	£19.88
MPE20-M27S-OR	20	M27 x 2	£24.37
MPE25-M33S-OR	25	M33 x 2	£44.49
MPE30-M42S-OR	30	M42 x 2	£75.24
MPE38-M48S-OR	38	M48 x 2	£107.39

Heavy Series

PGC: 234	OD (mm)	Thread	Price
MP45E6-M12S-OR	6	M12 x 1.5	£28.18
MP45E8-M14S-OR	8	M14 x 1.5	£24.28
MP45E10-M16S-OR	10	M16 x 1.5	£25.43
MP45E12-M18S-OR	12	M18 x 1.5	£32.95
MP45E16-M22S-OR	16	M22 x 1.5	£35.81
MP45E20-M27S-OR	20	M27 x 2	£50.46
MP45E25-M33S-OR	25	M33 x 2	£79.18
MP45E30-M42S-OR	30	M42 x 2	£130.21
MP45E38-M48S-OR	38	M48 x 2	£157.95

Positionable Tees

02

Positionable Branch Tee

Male Thread BSPP
O-Ring Seal
Light Series



PGC: 234	OD (mm)	BSPP	Price
MPBT8-1/4L-OR	8	1/4	£15.60
MPBT10-1/4L-OR	10	1/4	£18.05
MPBT12-3/8L-OR	12	3/8	£20.04
MPBT15-1/2L-OR	15	1/2	£23.29
MPBT18-1/2L-OR	18	1/2	£28.45
MPBT22-3/4L-OR	22	3/4	£38.41
MPBT28-1L-OR	28	1	£73.68
MPBT35-11/4L-OR	35	1 1/4	£103.46
MPBT42-11/2L-OR	42	1 1/2	£114.50

Positionable Run Tee

Male Thread BSPP
O-Ring Seal
Light Series



PGC: 234	OD (mm)	BSPP	Price
MPRT8-1/4L-OR	8	1/4	£15.60
MPRT10-1/4L-OR	10	1/4	£18.05
MPRT12-3/8L-OR	12	3/8	£20.04
MPRT15-1/2L-OR	15	1/2	£23.29
MPRT18-1/2L-OR	18	1/2	£28.45
MPRT22-3/4L-OR	22	3/4	£38.41
MPRT28-1L-OR	28	1	£72.87
MPRT35-11/4L-OR	35	1 1/4	£103.46
MPRT42-11/2L-OR	42	1 1/2	£114.50

Heavy Series

PGC: 234	OD (mm)	BSPP	Price
MPBT6-1/4S-OR	6	1/4	£41.55
MPBT8-1/4S-OR	8	1/4	£17.84
MPBT10-3/8S-OR	10	3/8	£20.04
MPBT12-3/8S-OR	12	3/8	£22.85
MPBT16-1/2S-OR	16	1/2	£28.75
MPBT20-3/4S-OR	20	3/4	£39.28
MPBT25-1S-OR	25	1	£76.48
MPBT30-11/4S-OR	30	1 1/4	£104.74
MPBT38-11/2S-OR	38	1 1/2	£120.54

Heavy Series

PGC: 234	OD (mm)	BSPP	Price
MPRT6-1/4S-OR	6	1/4	£41.55
MPRT8-1/4S-OR	8	1/4	£18.04
MPRT10-3/8S-OR	10	3/8	£20.04
MPRT12-3/8S-OR	12	3/8	£22.85
MPRT16-1/2S-OR	16	1/2	£28.75
MPRT20-3/4S-OR	20	3/4	£39.28
MPRT25-1S-OR	25	1	£74.51
MPRT30-11/4S-OR	30	1 1/4	£104.74
MPRT38-11/2S-OR	38	1 1/2	£120.54

Positionable Branch Tee

Male Thread Metric
O-Ring Seal
Light Series



PGC: 234	OD (mm)	Thread	Price
MPBT6-M10L-OR	6	M10 x 1	£15.60
MPBT8-M12L-OR	8	M12 x 1.5	£15.60
MPBT10-M14L-OR	10	M14 x 1.5	£18.05
MPBT12-M16L-OR	12	M16 x 1.5	£20.04
MPBT15-M18L-OR	15	M18 x 1.5	£23.29
MPBT18-M22L-OR	18	M22 x 1.5	£28.45
MPBT22-M27L-OR	22	M27 x 2	£38.41
MPBT28-M33L-OR	28	M33 x 2	£73.68
MPBT35-M42L-OR	35	M42 x 2	£103.46
MPBT42-M48L-OR	42	M48 x 2	£114.50

Positionable Run Tee

Male Thread Metric
O-Ring Seal
Light Series



PGC: 234	OD (mm)	Thread	Price
MPRT6-M10L-OR	6	M10 x 1	£37.96
MPRT8-M12L-OR	8	M12 x 1.5	£41.51
MPRT10-M14L-OR	10	M14 x 1.5	£16.65
MPRT12-M16L-OR	12	M16 x 1.5	£19.27
MPRT15-M18L-OR	15	M18 x 1.5	£24.18
MPRT18-M22L-OR	18	M22 x 1.5	£28.45
MPRT22-M27L-OR	22	M27 x 2	£38.37
MPRT28-M33L-OR	28	M33 x 2	£73.68
MPRT35-M42L-OR	35	M42 x 2	£110.96
MPRT42-M48L-OR	42	M48 x 2	£122.29

Heavy Series

PGC: 234	OD (mm)	Thread	Price
MPBT6-M12S-OR	6	M12 x 1.5	£41.55
MPBT8-M14S-OR	8	M14 x 1.5	£17.84
MPBT10-M16S-OR	10	M16 x 1.5	£20.04
MPBT12-M18S-OR	12	M18 x 1.5	£22.85
MPBT16-M22S-OR	16	M22 x 1.5	£28.75
MPBT20-M27S-OR	20	M27 x 2	£39.28
MPBT25-M33S-OR	25	M33 x 2	£76.48
MPBT30-M42S-OR	30	M42 x 2	£104.74
MPBT38-M48S-OR	38	M48 x 2	£120.54

Heavy Series

PGC: 234	OD (mm)	Thread	Price
MPRT6-M12S-OR	6	M12 x 1.5	£16.55
MPRT8-M14S-OR	8	M14 x 1.5	£16.57
MPRT10-M16S-OR	10	M16 x 1.5	£19.27
MPRT12-M18S-OR	12	M18 x 1.5	£26.67
MPRT16-M22S-OR	16	M22 x 1.5	£28.75
MPRT20-M27S-OR	20	M27 x 2	£39.21
MPRT25-M33S-OR	25	M33 x 2	£75.32
MPRT30-M42S-OR	30	M42 x 2	£100.70
MPRT38-M48S-OR	38	M48 x 2	£139.29



DIN 2353 Metric Steel Compression Fittings

Banjo Tee Couplings

Banjo Tee Coupling

Male Thread BSPP
Light Series



PGC: 234	OD (mm)	BSPP	Working Pressure (bar)	Price
MBJT6-1/8L	6	1/8	500	£22.48
MBJT8-1/4L	8	1/4	500	£24.65
MBJT10-1/4L	10	1/4	500	£28.45
MBJT12-3/8L	12	3/8	400	£30.71
MBJT15-1/2L	15	1/2	400	£44.22
MBJT18-1/2L	18	1/2	400	£55.09
MBJT22-3/4L	22	3/4	250	£86.40
MBJT28-1L	28	1	250	£129.93
MBJT35-1/4L	35	1 1/4	250	£176.01
MBJT42-11/2L	42	1 1/2	250	£219.03

Heavy Series

PGC: 234	OD (mm)	BSPP	Working Pressure (bar)	Price
MBJT6-1/4S	6	1/4	500	£25.99
MBJT8-1/4S	8	1/4	500	£29.78
MBJT10-3/8S	10	3/8	500	£32.79
MBJT12-3/8S	12	3/8	500	£42.75
MBJT14-1/2S	14	1/2	500	£52.94
MBJT16-1/2S	16	1/2	500	£59.23
MBJT20-3/4S	20	3/4	400	£94.69
MBJT25-1S	25	1	400	£136.92
MBJT30-11/4S	30	1 1/4	400	£178.06
MBJT38-11/2S	38	1 1/2	400	£234.49

Banjo Tee Coupling

Male Thread Metric
Light Series



PGC: 234	OD (mm)	Thread	Working Pressure (bar)	Price
MBJT6-M10L	6	M10 x 1	500	£22.45
MBJT8-M12L	8	M12 x 1.5	500	£24.43
MBJT10-M14L	10	M14 x 1.5	500	£28.62
MBJT12-M16L	12	M16 x 1.5	400	£30.25
MBJT15-M18L	15	M18 x 1.5	400	£44.61
MBJT18-M22L	18	M22 x 1.5	400	£58.35
MBJT22-M26L	22	M26 x 1.5	250	£97.86
MBJT28-M33L	28	M33 x 2	250	£129.84
MBJT35-M42L	35	M42 x 2	250	£178.67
MBJT42-M48L	42	M48 x 2	250	£218.83

Heavy Series

PGC: 234	OD (mm)	Thread	Working Pressure (bar)	Price
MBJT6-M12S	6	M12 x 1.5	500	£24.67
MBJT8-M14S	8	M14 x 1.5	500	£29.95
MBJT10-M16S	10	M16 x 1.5	500	£32.33
MBJT12-M18S	12	M18 x 1.5	500	£42.37
MBJT14-M20S	14	M20 x 1.5	500	£53.70
MBJT16-M22S	16	M22 x 1.5	500	£65.96
MBJT20-M27S	20	M27 x 2	400	£95.59
MBJT25-M33S	25	M33 x 2	400	£136.83
MBJT30-M42S	30	M42 x 2	400	£178.67
MBJT38-M48S	38	M48 x 2	400	£234.28

Banjo Couplings

High Pressure Banjo Coupling

Male Thread BSPP
Light Series



PGC: 234	OD (mm)	BSPP	Working Pressure (bar)	Price
MBJ6-1/8HPL	6	1/8	500	£11.99
MBJ8-1/4HPL	8	1/4	500	£15.78
MBJ10-1/4HPL	10	1/4	500	£13.44
MBJ12-3/8HPL	12	3/8	400	£17.14
MBJ15-1/2HPL	15	1/2	400	£20.99
MBJ18-1/2HPL	18	1/2	400	£28.78
MBJ22-3/4HPL	22	3/4	250	£45.80
MBJ28-1HPL	28	1	250	£72.77
MBJ35-11/4HPL	35	1 1/4	250	£108.63
MBJ42-11/2HPL	42	1 1/2	250	£146.04

Heavy Series

PGC: 234	OD (mm)	BSPP	Working Pressure (bar)	Price
MBJ6-1/4HPS	6	1/4	500	£13.11
MBJ8-1/4HPS	8	1/4	500	£13.71
MBJ10-3/8HPS	10	3/8	500	£17.58
MBJ12-3/8HPS	12	3/8	500	£17.83
MBJ14-1/2HPS	14	1/2	500	£25.06
MBJ16-1/2HPS	16	1/2	500	£28.87
MBJ20-3/4HPS	20	3/4	400	£47.07
MBJ25-1HPS	25	1	400	£74.20
MBJ30-11/4HPS	30	1 1/4	400	£112.75
MBJ38-11/2HPS	38	1 1/2	400	£154.79

High Pressure Banjo Coupling

Male Thread Metric
Light Series



PGC: 234	OD (mm)	Thread	Working Pressure (bar)	Price
MBJ6-M10HPL	6	M10 x 1	500	£11.99
MBJ8-M12HPL	8	M12 x 1.5	500	£12.85
MBJ10-M14HPL	10	M14 x 1.5	500	£13.61
MBJ12-M16HPL	12	M16 x 1.5	400	£16.68
MBJ15-M18HPL	15	M18 x 1.5	400	£18.11
MBJ18-M22HPL	18	M22 x 1.5	400	£28.70
MBJ22-M26HPL	22	M26 x 1.5	250	£41.94
MBJ28-M33HPL	28	M33 x 2	250	£72.68
MBJ35-M42HPL	35	M42 x 2	250	£109.23
MBJ42-M48HPL	42	M48 x 2	250	£145.83

Heavy Series

PGC: 234	OD (mm)	Thread	Working Pressure (bar)	Price
MBJ6-M12HPS	6	M12 x 1.5	500	£13.23
MBJ8-M14HPS	8	M14 x 1.5	500	£13.87
MBJ10-M16HPS	10	M16 x 1.5	500	£17.13
MBJ12-M18HPS	12	M18 x 1.5	500	£19.17
MBJ14-M20HPS	14	M20 x 1.5	500	£41.43
MBJ16-M22HPS	16	M22 x 1.5	500	£29.99
MBJ20-M27HPS	20	M27 x 2	400	£47.97
MBJ25-M33HPS	25	M33 x 2	400	£74.09
MBJ30-M42HPS	30	M42 x 2	400	£113.35
MBJ38-M48HPS	38	M48 x 2	400	£154.59



Banjo Coupling

Male Thread BSPP
Light Light Series



PGC: 234	OD (mm)	BSPP	Working Pressure (bar)	Price
MBJ4-1/8LL	4	1/8	100	£13.55
MBJ6-1/8LL	6	1/8	100	£13.52
MBJ8-1/8LL	8	1/8	100	£13.52

Light Series

PGC: 234	OD (mm)	BSPP	Working Pressure (bar)	Price
MBJ6-1/8L	6	1/8	250	£11.40
MBJ8-1/4L	8	1/4	250	£13.55
MBJ10-1/4L	10	1/4	250	£14.04
MBJ12-1/4L	12	1/4	250	£17.98
MBJ12-3/8L	12	3/8	250	£16.40
MBJ15-1/2L	15	1/2	250	£20.69
MBJ18-1/2L	18	1/2	160	£24.72
MBJ22-3/4L	22	3/4	160	£35.39

Heavy Series

PGC: 234	OD (mm)	BSPP	Working Pressure (bar)	Price
MBJ6-1/4S	6	1/4	250	£13.76
MBJ8-1/4S	8	1/4	250	£14.84
MBJ10-3/8S	10	3/8	250	£16.94
MBJ12-3/8S	12	3/8	250	£17.98
MBJ14-1/2S	14	1/2	250	£29.10
MBJ16-1/2S	16	1/2	160	£25.42
MBJ20-3/4S	20	3/4	160	£35.01

Banjo Coupling

Male Thread Metric
Light Light Series



PGC: 234	OD (mm)	Thread	Working Pressure (bar)	Price
MBJ4-M8LL	4	M8 x 1	100	£13.50
MBJ6-M10LL	6	M10 x 1	100	£13.49
MBJ8-M10LL	8	M10 x 1	100	£13.43

Light Series

PGC: 234	OD (mm)	Thread	Working Pressure (bar)	Price
MBJ6-M10L	6	M10 x 1	250	£11.57
MBJ8-M12L	8	M12 x 1.5	250	£12.99
MBJ10-M14L	10	M14 x 1.5	250	£14.13
MBJ12-M16L	12	M16 x 1.5	250	£16.59
MBJ15-M18L	15	M18 x 1.5	250	£19.32
MBJ18-M22L	18	M22 x 1.5	160	£25.18
MBJ22-M26L	22	M26 x 1.5	160	£33.98

Heavy Series

PGC: 234	OD (mm)	Thread	Working Pressure (bar)	Price
MBJ6-M12S	6	M12 x 1.5	250	£13.39
MBJ8-M14S	8	M14 x 1.5	250	£14.35
MBJ10-M16S	10	M16 x 1.5	250	£16.94
MBJ12-M18S	12	M18 x 1.5	250	£17.60
MBJ14-M20S	14	M20 x 1.5	250	£28.56
MBJ16-M22S	16	M22 x 1.5	160	£27.25

Choke Free Banjo Coupling

Male Thread BSPP
Light Series



PGC: 234	OD (mm)	BSPP	Working Pressure (bar)	Price
MBJ6-1/8CFL	6	1/8	250	£18.61
MBJ8-1/4CFL	8	1/4	250	£16.10
MBJ10-1/4CFL	10	1/4	250	£16.48
MBJ12-3/8CFL	12	3/8	250	£20.61
MBJ15-1/2CFL	15	1/2	250	£24.94
MBJ18-1/2CFL	18	1/2	100	£34.98
MBJ22-3/4CFL	22	3/4	100	£55.26
MBJ28-1CFL	28	1	100	£88.24
MBJ35-11/4CFL	35	1 1/4	100	£132.48
MBJ42-11/2CFL	42	1 1/2	100	£178.06

Heavy Series

PGC: 234	OD (mm)	BSPP	Working Pressure (bar)	Price
MBJ6-1/4CFS	6	1/4	400	£16.15
MBJ8-1/4CFS	8	1/4	400	£16.81
MBJ10-3/8CFS	10	3/8	400	£21.17
MBJ12-3/8CFS	12	3/8	400	£21.46
MBJ14-1/2CFS	14	1/2	400	£31.11
MBJ16-1/2CFS	16	1/2	400	£35.01
MBJ20-3/4CFS	20	3/4	400	£56.54
MBJ25-1CFS	25	1	250	£89.95
MBJ30-11/4CFS	30	1 1/4	250	£137.57
MBJ38-11/2CFS	38	1 1/2	250	£188.49

Choke Free Banjo Coupling

Male Thread Metric
Light Series



PGC: 234	OD (mm)	Thread	Working Pressure (bar)	Price
MBJ6-M10CFL	6	M10 x 1	250	£18.68
MBJ8-M12CFL	8	M12 x 1.5	250	£15.64
MBJ10-M14CFL	10	M14 x 1.5	250	£17.66
MBJ12-M16CFL	12	M16 x 1.5	250	£20.15
MBJ15-M18CFL	15	M15 x 1.5	250	£23.85
MBJ18-M22CFL	18	M22 x 1.5	100	£34.73
MBJ22-M26CFL	22	M26 x 1.5	100	£50.76
MBJ28-M33CFL	28	M33 x 2	100	£88.48
MBJ35-M42CFL	35	M42 x 2	100	£133.36
MBJ42-M48CFL	42	M48 x 2	100	£178.06

Heavy Series

PGC: 234	OD (mm)	Thread	Working Pressure (bar)	Price
MBJ6-M12CFS	6	M12 x 1.5	400	£16.03
MBJ8-M14CFS	8	M14 x 1.5	400	£16.86
MBJ10-M16CFS	10	M16 x 1.5	400	£20.88
MBJ12-M18CFS	12	M18 x 1.5	400	£23.17
MBJ14-M20CFS	14	M20 x 1.5	400	£32.13
MBJ16-M22CFS	16	M22 x 1.5	400	£36.36
MBJ20-M27CFS	20	M27 x 2	400	£57.27
MBJ25-M33CFS	25	M33 x 2	250	£90.19
MBJ30-M42CFS	30	M42 x 2	250	£138.46
MBJ38-M48CFS	38	M48 x 2	250	£188.49



DIN 2353 Metric Steel Compression Fittings

Male Standpipe Adaptors - Form E

Male Standpipe Adaptor Form E

Male Thread BSPP
WD Captive Seal
Light Series



PGC: 234	OD (mm)	BSPP	Price
MSA6-1/8L	6	1/8	£5.37
MSA8-1/4L	8	1/4	£5.65
MSA10-1/4L	10	1/4	£5.85
MSA10-3/8L	10	3/8	£6.38
MSA12-1/4L	12	1/4	£7.37
MSA12-3/8L	12	3/8	£6.05
MSA15-1/2L	15	1/2	£8.06
MSA18-1/2L	18	1/2	£9.11
MSA18-3/4L	18	3/4	£37.46
MSA22-3/4L	22	3/4	£13.56
MSA28-1L	28	1	£19.95
MSA35-11/4L	35	1 1/4	£34.75
MSA42-11/2L	42	1 1/2	£38.30

Heavy Series

PGC: 234	OD (mm)	BSPT	Price
MSA6-1/4S	6	1/4	£6.13
MSA8-1/4S	8	1/4	£6.26
MSA10-3/8S	10	3/8	£6.38
MSA12-1/2S	12	1/2	£9.05
MSA12-3/8S	12	3/8	£6.54
MSA14-1/2S	14	1/2	£12.82
MSA16-1/2S	16	1/2	£10.04
MSA16-3/4S	16	3/4	£29.54
MSA20-3/4S	20	3/4	£15.07
MSA25-1S	25	1	£21.35
MSA30-11/4S	30	1 1/4	£32.46
MSA38-11/2S	38	1 1/2	£50.28

Male Standpipe Adaptor Form E

Male Thread Metric
WD Captive Seal
Light Series



PGC: 234	OD (mm)	Thread	Price
MSA6-M10L	6	M10 x 1	£6.13
MSA8-M12L	8	M12 x 1.5	£6.29
MSA10-M14L	10	M14 x 1.5	£6.51
MSA12-M16L	12	M16 x 1.5	£7.17
MSA15-M18L	15	M26 x 1.5	£8.50
MSA18-M22L	18	M18 x 1.5	£9.62
MSA22-M26L	22	M26 x 1.5	£14.52
MSA28-M33L	28	M33 x 2	£23.76
MSA35-M42L	35	M42 x 2	£36.16
MSA42-M48L	42	M48 x 2	£41.29

Heavy Series

PGC: 234	OD (mm)	Thread	Price
MSA6-M14S	6	M10 x 1	£7.19
MSA8-M16S	8	M12 x 1.5	£7.43
MSA10-M16S	10	M14 x 1.5	£7.62
MSA12-M18S	12	M16 x 1.5	£7.96
MSA16-M22S	15	M15 x 1.5	£10.76
MSA20-M27S	18	M22 x 1.5	£16.30
MSA25-M22S	22	M26 x 1.5	£25.16
MSA30-M42S	28	M33 x 2	£37.65
MSA38-M48S	35	M42 x 2	£55.86

Welding Nipples & Bosses

Welding Nipple

With O-Ring Gasket



PGC: 234	OD (mm)	Wall (mm)	Price
MWN10-1	10	1	£4.25
MWN10-1.5	10	1.5	£3.61
MWN10-2	10	2	£3.61
MWN12-1.5	12	1.5	£3.98
MWN12-2	12	2	£3.98
MWN12-2.5	12	2.5	£3.98
MWN16-1.5	16	1.5	£4.93
MWN16-2	16	2	£4.93
MWN16-2.5	16	2.5	£4.93
MWN16-3	16	3	£4.93
MWN20-2	20	2	£6.35
MWN20-2.5	20	2.5	£6.35
MWN20-3	20	3	£6.35
MWN20-4	20	4	£6.35
MWN25-3	25	3	£7.92
MWN25-4	25	4	£7.92
MWN25-5	25	5	£10.10
MWN30-3	30	3	£10.42
MWN30-4	30	4	£10.42
MWN30-5	30	5	£10.42
MWN30-6	30	6	£16.61
MWN38-4	38	4	£14.62
MWN38-5	38	5	£14.62
MWN38-6	38	6	£19.37
MWN38-7	38	7	£22.84

Welding Boss

Light Series



PGC: 234	OD (mm)	Price
MWB6L	6	£2.43
MWB8L	8	£2.87
MWB12L	12	£3.69
MWB15L	15	£4.67
MWB18L	18	£6.49
MWB22L	22	£9.48
MWB28L	28	£17.39
MWB35L	35	£24.33
MWB42L	42	£32.69

Heavy Series

PGC: 234	OD (mm)	Price
MWB6S	6	£3.17
MWB8S	8	£3.74
MWB10S	10	£4.25
MWB12S	12	£5.00
MWB14S	14	£7.84
MWB16S	16	£7.32
MWB20S	20	£10.61
MWB25S	25	£17.96
MWB30S	30	£25.37
MWB38S	38	£37.26

Non Return Valves & Tube Inserts

Non Return Valve

1 bar Opening Pressure
Light Series



PGC: 234	OD (mm)	Price
MNRV6L	6	£16.94
MNRV8L	8	£17.68
MNRV10L	10	£21.42
MNRV12L	12	£26.97
MNRV15L	15	£35.08
MNRV18L	18	£46.55
MNRV22L	22	£74.59
MNRV28L	28	£105.72
MNRV35L	35	£135.93
MNRV42L	42	£154.66

Heavy Series

PGC: 234	OD (mm)	Price
MNRV6S	6	£22.58
MNRV8S	8	£23.29
MNRV10S	10	£27.92
MNRV12S	12	£29.52
MNRV14S	14	£49.97
MNRV16S	16	£47.29
MNRV20S	20	£76.62
MNRV25S	25	£94.72
MNRV30S	30	£118.78
MNRV38S	38	£151.41

Non Return Valve

Female Thread BSPP
5 bar Opening Pressure



PGC: 234	BSPP	Price
NRV2HP-5BAR	1/8	£35.34
NRV4HP-5BAR	1/4	£32.55
NRV6HP-5BAR	3/8	£51.43
NRV8HP-5BAR	1/2	£61.97
NRV12HP-5BAR	3/4	£81.85
NRV16HP-5BAR	1	£111.05
NRV20HP-5BAR	1 1/4	£199.07
NRV24HP-5BAR	1 1/2	£248.11

Tube Insert

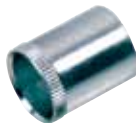

PGC: 234	OD (mm)	ID (mm)	Price
MT16-1	6	4	£1.24
MT18-1	8	6	£0.84
MT110-1	10	8	£0.90
MT110-1.5	10	7	£0.85
MT112-1	12	10	£1.14
MT112-1.5	12	9	£1.00
MT114-1.5	14	11	£1.75
MT115-1	15	13	£1.39
MT115-1.5	15	12	£1.49
MT118-1	18	16	£1.73
MT118-1.5	18	15	£1.73
MT122-1.5	22	19	£1.60
MT122-2	22	18	£1.70
MT128-1.5	28	25	£2.98
MT128-2	28	24	£3.08

Non Return Valves - Form E

Non Return Valve Form E

Male Thread BSPP
WD Captive Seal
1 bar Opening Pressure
Light Series



PGC: 234	OD (mm)	BSPP	Price
MNRV6-1/8L	6	1/8	£16.15
MNRV8-1/4L	8	1/4	£17.85
MNRV10-1/4L	10	1/4	£21.64
MNRV12-3/8L	12	3/8	£26.69
MNRV15-1/2L	15	1/2	£33.37
MNRV18-1/2L	18	1/2	£45.94
MNRV22-3/4L	22	3/4	£73.89
MNRV28-1L	28	1	£106.64
MNRV35-11/4L	35	1 1/4	£137.45
MNRV42-11/2L	42	1 1/2	£150.00

Heavy Series

PGC: 234	OD (mm)	BSPP	Price
MNRV6-1/46S	6	1/4	£22.73
MNRV8-1/4S	8	1/4	£22.99
MNRV10-3/8S	10	3/8	£27.78
MNRV12-3/8S	12	3/8	£29.34
MNRV14-1/2S	14	1/2	£59.25
MNRV16-1/2S	16	1/2	£46.61
MNRV20-3/4S	20	3/4	£74.58
MNRV25-1S	25	1	£89.85
MNRV30-11/4S	30	1 1/4	£118.73
MNRV38-11/2S	38	1 1/2	£148.85

Non Return Valve Form E

Male Thread BSPP
WD Captive Seal
1 bar Opening Pressure
Light Series



PGC: 234	BSPP	OD (mm)	Price
MNRV1/8-6L	1/8	6	£16.32
MNRV1/4-8L	1/4	8	£17.95
MNRV1/4-10L	1/4	10	£21.73
MNRV3/8-12L	3/8	12	£26.78
MNRV1/2-15L	1/2	15	£33.56
MNRV1/2-18L	1/2	18	£46.13
MNRV3/4-22L	3/4	22	£74.10
MNRV1-28L	1	28	£106.96
MNRV11/4-35L	1 1/4	35	£137.79
MNRV11/2-42L	1 1/2	42	£150.88



NanoProtect™ is the new brand label and quality sign for the safe chrome(VI)-free surface protection of EMB's hydraulic fittings. With the introduction of this technology, EMB fulfilled EU directive 2000/53/EG for the automotive industry which came into force in July 2007. The effect: today, users in mechanical engineering and mobile hydraulics are able to use a surface technology which is both environmentally-friendly and reduces recycling costs.

This innovative surface protection with its attractive silver-grey appearance is the result of intensive Research & Development in electroplating technology and extensive tests in laboratories and in the field.



The optimised passivation method results in a much better corrosion protection than the conventional Cr(VI)-containing passivation with its yellow-chromated surface can offer.

As a consequence, the engineer can make use of a proven programme of high-grade hydraulic fittings with an optimised cost-benefit relationship which does not necessitate changes in assembly technology.

Triple safety with the EMB NanoProtect™-hydraulic fittings:

Highest corrosion resistance against white rust and red rust and protection against damage during handling and assembly. First layer zinc (Zn), second layer Cr(VI)-free passivation and, as a third layer, the EMB sealing.

This is why **NanoProtect™** is an extremely economical and future-oriented solution for the rough everyday application in both stationary and mobile hydraulics as well as in compressed air technology:

The surface layer is 9 µm - 14 µm thick and offers a high degree of resilience. It is resistant to hydraulic media; its friction co-efficient is lower than that of the usual A3L surfaces. If the silver-grey **NanoProtect™**-surface appearance is not desired, the fittings can be painted in the machine or plant colours with usual coatings.

This is why **NanoProtect™** is environmentally-friendly: The new Cr(VI) and nickel-free **NanoProtect™** surface protects the resources during all levels of the production process – and it is compliant with the EU old vehicles directive 2000/53/EG and the EU Directive 2002/95/EG (RoHs) on the restricted use of certain hazardous substances in electrical and electronic equipment.

Technical Data

Layer Thickness: 9 µm - 14 µm.

Corrosion Resistance: (Salt Spray Test according to DIN EN ISO 9227):
resistance against white rust: >240 h
resistance against red rust: > 500 h.

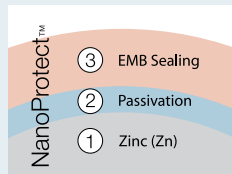

DIN EN ISO 9227 Salt Spray Test

Colour: Metallic silver-grey.

Assembly Behaviour: Reduced friction coefficient in comparison with the usual A3L surface. As a consequence, reduced assembly forces (higher safety against faulty assembly).

Media Resistance: Resistant against all usual hydraulic media.

Paintability: Paintability with usual coatings and anti-corrosive agents (Test is recommended).

Environmental Compatibility: Future-oriented fulfilment of EU directives 2000/53 EG and 2002/95/EG (RoHs).

Quality-assured and resources-saving production process.





Tube Nuts & Cutting Rings

Tube Nut
Light Light Series



PGC: 235	OD (mm)	Price
MN4LL-SS	4	£3.63
MN6LL-SS	6	£4.11
MN8LL-SS	8	£4.84

Light Series

PGC: 235	OD (mm)	Price
MN6L-SS	6	£3.40
MN8L-SS	8	£4.06
MN10L-SS	10	£4.63
MN12L-SS	12	£5.34
MN15L-SS	15	£7.43
MN18L-SS	18	£13.70
MN22L-SS	22	£16.57
MN28L-SS	28	£24.51
MN35L-SS	35	£36.17
MN42L-SS	42	£48.55

Heavy Series

PGC: 235	OD (mm)	Price
MN6S-SS	6	£4.38
MN8S-SS	8	£4.88
MN10S-SS	10	£5.78
MN12S-SS	12	£6.51
MN14S-SS	14	£9.08
MN16S-SS	16	£13.37
MN20S-SS	20	£17.52
MN25S-SS	25	£32.46
MN30S-SS	30	£41.44
MN38S-SS	38	£58.19

Cutting Ring
Light Light Series



PGC: 235	OD (mm)	Price
MF4LL-SS	4	£1.13
MF6LL-SS	6	£1.31
MF8LL-SS	8	£1.62

Light Series

PGC: 235	OD (mm)	Price
MF6LS-SS	6	£1.22
MF8LS-SS	8	£1.37
MF10LS-SS	10	£1.89
MF12LS-SS	12	£1.91
MF15L-SS	15	£2.35
MF18L-SS	18	£2.61
MF22L-SS	22	£2.88
MF28L-SS	28	£4.81
MF35L-SS	35	£6.76
MF42L-SS	42	£7.99

Heavy Series

PGC: 235	OD (mm)	Price
MF14S-SS	14	£2.62
MF16S-SS	16	£2.36
MF20S-SS	20	£2.76
MF25S-SS	25	£4.47
MF30S-SS	30	£6.26
MF38S-SS	38	£6.71

DIN 2353 Metric Stainless Steel Compression Fittings

Blanking Caps & Plugs

Blanking Cap

24° Cone
Light Series



PGC: 235	OD (mm)	Price
MBC6L-SS	6	£17.55
MBC8L-SS	8	£17.71
MBC10L-SS	10	£20.47
MBC12L-SS	12	£23.18
MBC15L-SS	15	£27.36
MBC18L-SS	18	£39.53
MBC22L-SS	22	£50.49
MBC28L-SS	28	£73.49

Heavy Series

PGC: 235	OD (mm)	Price
MBC6S-SS	6	£17.46
MBC8S-SS	8	£21.96
MBC10S-SS	10	£23.42
MBC12S-SS	12	£25.30
MBC14S-SS	14	£30.23
MBC16S-SS	16	£37.81
MBC20S-SS	20	£50.02
MBC25S-SS	25	£75.33

Blanking Plug

Light Series



PGC: 235	OD (mm)	To Suit Nut (mm)	Price
MBP6LS-SS	6	6	£10.04
MBP8LS-SS	8	8	£10.82
MBP10LS-SS	10	10	£11.22
MBP12LS-SS	12	12	£13.38
MBP15L-SS	15	15	£14.83
MBP18L-SS	18	18	£19.23
MBP22L-SS	22	22	£26.19
MBP28L-SS	28	28	£38.34
MBP35L-SS	35	35	£65.74
MBP42L-SS	42	42	£81.94

Straight Couplings

Straight Coupling
Light Light Series



PGC: 235	OD (mm)	Price
MSC4LL-SS	4	£23.13
MSC6LL-SS	6	£25.67
MSC8LL-SS	8	£28.51

Light Series

PGC: 235	OD (mm)	Price
MSC6L-SS	6	£17.23
MSC8L-SS	8	£20.13
MSC10L-SS	10	£23.95
MSC12L-SS	12	£27.82
MSC15L-SS	15	£35.74
MSC18L-SS	18	£54.12
MSC22L-SS	22	£69.95
MSC28L-SS	28	£109.36
MSC35L-SS	35	£153.22
MSC42L-SS	42	£201.25

Heavy Series

PGC: 235	OD (mm)	Price
MSC6S-SS	6	£20.28
MSC8S-SS	8	£23.71
MSC10S-SS	10	£29.15
MSC12S-SS	12	£32.48
MSC14S-SS	14	£44.97
MSC16S-SS	16	£55.07
MSC20S-SS	20	£73.37
MSC25S-SS	25	£125.60
MSC30S-SS	30	£173.78
MSC38S-SS	38	£223.26

Equal Bulkheads

Equal Bulkhead
Light Series



PGC: 235	OD (mm)	Price
MBH6L-SS	6	£34.01
MBH8L-SS	8	£37.91
MBH10L-SS	10	£49.37
MBH12L-SS	12	£51.94
MBH15L-SS	15	£67.20
MBH18L-SS	18	£104.72
MBH22L-SS	22	£131.15
MBH28L-SS	28	£193.54
MBH35L-SS	35	£220.57
MBH42L-SS	42	£292.31

Heavy Series

PGC: 235	OD (mm)	Price
MBH6S-SS	6	£44.52
MBH8S-SS	8	£51.16
MBH10S-SS	10	£58.83
MBH12S-SS	12	£57.86
MBH14S-SS	14	£83.13
MBH16S-SS	16	£109.17
MBH20S-SS	20	£167.32
MBH25S-SS	25	£232.22
MBH30S-SS	30	£247.17
MBH38S-SS	38	£365.65



Equal Crosses

Equal Cross

Light Series



PGC: 235	OD (mm)	Price
MX6L-SS	6	£77.72
MX8L-SS	8	£84.03
MX10L-SS	10	£102.74
MX12L-SS	12	£112.11
MX15L-SS	15	£143.62
MX18L-SS	18	£202.86
MX22L-SS	22	£277.52
MX28L-SS	28	£369.07

Heavy Series

PGC: 235	OD (mm)	Price
MX6S-SS	6	£84.03
MX8S-SS	8	£107.45
MX10S-SS	10	£116.84
MX12S-SS	12	£136.06
MX14S-SS	14	£196.37
MX16S-SS	16	£196.37
MX20S-SS	20	£282.89
MX25S-SS	25	£406.86

Equal Elbows

Equal Elbow

Light Light Series



PGC: 235	OD (mm)	Price
ME4LL-SS	4	£39.82
ME6LL-SS	6	£41.90
ME8LL-SS	8	£45.10

Light Series

PGC: 235	OD (mm)	Price
ME6L-SS	6	£30.30
ME8L-SS	8	£31.93
ME10L-SS	10	£37.26
ME12L-SS	12	£42.11
ME15L-SS	15	£54.12
ME18L-SS	18	£79.16
ME22L-SS	22	£97.70
ME28L-SS	28	£184.06
ME35L-SS	35	£271.39
ME42L-SS	42	£424.73

Heavy Series

PGC: 235	OD (mm)	Price
ME6S-SS	6	£33.40
ME8S-SS	8	£37.90
ME10S-SS	10	£44.40
ME12S-SS	12	£50.27
ME14S-SS	14	£73.66
ME16S-SS	16	£77.71
ME20S-SS	20	£105.44
ME25S-SS	25	£216.23
ME30S-SS	30	£278.59
ME38S-SS	38	£416.92

Equal Tees

Equal Tee

Light Light Series



PGC: 235	OD (mm)	Price
MT4LL-SS	4	£57.00
MT6LL-SS	6	£59.44
MT8LL-SS	8	£67.45

Light Series

PGC: 235	OD (mm)	Price
MT6L-SS	6	£42.92
MT8L-SS	8	£45.98
MT10L-SS	10	£51.61
MT12L-SS	12	£60.73
MT15L-SS	15	£84.14
MT18L-SS	18	£119.44
MT22L-SS	22	£160.73
MT28L-SS	28	£256.00
MT35L-SS	35	£430.58
MT42L-SS	42	£602.26

Heavy Series

PGC: 235	OD (mm)	Price
MT6S-SS	6	£46.37
MT8S-SS	8	£50.45
MT10S-SS	10	£61.72
MT12S-SS	12	£74.65
MT14S-SS	14	£99.98
MT16S-SS	16	£117.29
MT20S-SS	20	£164.31
MT25S-SS	25	£276.45
MT30S-SS	30	£397.13
MT38S-SS	38	£626.43

Bulkhead Elbows

Bulkhead Elbow

Light Series



PGC: 235	OD (mm)	Price
MBHE6L-SS	6	£66.28
MBHE8L-SS	8	£65.39
MBHE10L-SS	10	£73.28
MBHE12L-SS	12	£79.63
MBHE15L-SS	15	£112.11
MBHE18L-SS	18	£148.08
MBHE22L-SS	22	£184.91
MBHE28L-SS	28	£253.49
MBHE35L-SS	35	£347.96
MBHE42L-SS	42	£513.33

Heavy Series

PGC: 235	OD (mm)	Price
MBHE6S-SS	6	£64.45
MBHE8S-SS	8	£75.59
MBHE10S-SS	10	£73.35
MBHE12S-SS	12	£84.38
MBHE14S-SS	14	£101.03
MBHE16S-SS	16	£117.11
MBHE20S-SS	20	£196.75
MBHE25S-SS	25	£294.58
MBHE30S-SS	30	£400.13
MBHE38S-SS	38	£597.60

Male Stud Couplings - Form B

Male Stud Coupling

Form B
Male Thread BSPP
Metal to Metal Seal
Light Light Series



PGC: 235	OD (mm)	BSPP	Price
MMC4-1/8LL-MM-SS	4	1/8	£16.63
MMC6-1/8LL-MM-SS	6	1/8	£17.30
MMC8-1/8LL-MM-SS	8	1/8	£19.16

Heavy Series

PGC: 235	OD (mm)	BSPP	Price
MMC8-1/4S-MM-SS	6	1/4	£13.77
MMC8-1/2S-MM-SS	6	1/2	£27.84
MMC8-1/4S-MM-SS	8	1/4	£15.85
MMC8-3/8S-MM-SS	8	3/8	£17.88
MMC10-1/4S-MM-SS	10	1/4	£20.84
MMC10-3/8S-MM-SS	10	3/8	£20.25
MMC10-1/2S-MM-SS	10	1/2	£28.37
MMC12-1/4S-MM-SS	12	1/4	£25.49
MMC12-3/8S-MM-SS	12	3/8	£22.13
MMC12-1/2S-MM-SS	12	1/2	£31.76
MMC14-3/8S-MM-SS	14	3/8	£27.22
MMC14-1/2S-MM-SS	14	1/2	£30.15
MMC16-3/8S-MM-SS	16	3/8	£38.48
MMC16-1/2S-MM-SS	16	1/2	£37.94
MMC20-1/2S-MM-SS	20	1/2	£56.81
MMC20-3/4S-MM-SS	20	3/4	£51.19
MMC25-3/4S-MM-SS	25	3/4	£91.05
MMC25-1S-MM-SS	25	1	£86.70
MMC30-3/4S-MM-SS	30	3/4	£105.14
MMC30-1S-MM-SS	30	1	£107.17
MMC30-11/4S-MM-SS	30	1 1/4	£105.14
MMC38-11/4S-MM-SS	38	1 1/4	£139.48
MMC38-11/2S-MM-SS	38	1 1/2	£132.84

Light Series

PGC: 235	OD (mm)	BSPP	Price
MMC6-1/8L-MM-SS	6	1/8	£12.32
MMC6-1/4L-MM-SS	6	1/4	£18.51
MMC6-3/8L-MM-SS	6	3/8	£25.53
MMC6-1/2L-MM-SS	6	1/2	£27.63
MMC8-1/8L-MM-SS	8	1/8	£15.34
MMC8-1/4L-MM-SS	8	1/4	£14.13
MMC8-3/8L-MM-SS	8	3/8	£21.41
MMC8-1/2L-MM-SS	8	1/2	£25.85
MMC10-1/4L-MM-SS	10	1/4	£15.69
MMC10-3/8L-MM-SS	10	3/8	£25.69
MMC10-1/2L-MM-SS	10	1/2	£29.52
MMC12-1/4L-MM-SS	12	1/4	£24.52
MMC12-3/8L-MM-SS	12	3/8	£19.38
MMC12-1/2L-MM-SS	12	1/2	£30.12
MMC15-3/8L-MM-SS	15	3/8	£29.75
MMC15-1/2L-MM-SS	15	1/2	£27.11
MMC15-3/4L-MM-SS	15	3/4	£44.49
MMC18-3/8L-MM-SS	18	3/8	£39.21
MMC18-1/2L-MM-SS	18	1/2	£36.30
MMC18-3/4L-MM-SS	18	3/4	£51.50
MMC22-1/2L-MM-SS	22	1/2	£64.44
MMC22-3/4L-MM-SS	22	3/4	£48.24
MMC22-1L-MM-SS	22	1	£68.25
MMC28-3/4L-MM-SS	28	3/4	£73.73
MMC28-1L-MM-SS	28	1	£77.50
MMC35-1L-MM-SS	35	1	£96.28
MMC35-11/4L-MM-SS	35	1 1/4	£96.28
MMC42-11/2L-MM-SS	42	1 1/2	£129.67

Male Stud Couplings - Form E

Male Stud Coupling

Form E
Male Thread BSPP
WD Captive Seal
Light Series



PGC: 235	OD (mm)	BSPP	Price
MMC6-1/4L-WD-SS	6	1/4	£23.27
MMC6-1/8L-WD-SS	6	1/8	£18.23
MMC8-1/8L-WD-SS	8	1/8	£22.31
MMC8-1/4L-WD-SS	8	1/4	£20.91
MMC8-3/8L-WD-SS	8	3/8	£26.20
MMC10-1/4L-WD-SS	10	1/4	£22.56
MMC10-3/8L-WD-SS	10	3/8	£29.56
MMC10-1/2L-WD-SS	10	1/2	£37.30
MMC12-1/4L-WD-SS	12	1/4	£30.84
MMC12-3/8L-WD-SS	12	3/8	£25.70
MMC12-1/2L-WD-SS	12	1/2	£37.73
MMC15-3/8L-WD-SS	15	3/8	£37.30
MMC15-1/2L-WD-SS	15	1/2	£33.54
MMC15-3/4L-WD-SS	15	3/4	£49.95
MMC18-3/8L-WD-SS	18	3/8	£47.01
MMC18-1/2L-WD-SS	18	1/2	£42.73
MMC18-3/4L-WD-SS	18	3/4	£62.46
MMC22-1/2L-WD-SS	22	1/2	£57.48
MMC22-3/4L-WD-SS	22	3/4	£52.67
MMC22-1L-WD-SS	22	1	£78.69
MMC28-3/4L-WD-SS	28	3/4	£87.01
MMC28-1L-WD-SS	28	1	£80.61
MMC28-11/4L-WD-SS	28	1 1/4	£92.70
MMC35-1L-WD-SS	35	1	£101.80
MMC35-11/4L-WD-SS	35	1 1/4	£101.80
MMC42-11/2L-WD-SS	42	1 1/2	£140.87

Heavy Series

PGC: 235	OD (mm)	BSPP	Price
MMC6-1/4S-WD-SS	6	1/4	£21.39
MMC8-1/4S-WD-SS	8	1/4	£20.91
MMC8-3/8S-WD-SS	8	3/8	£27.11
MMC10-1/4S-WD-SS	10	1/4	£14.52
MMC10-3/8S-WD-SS	10	3/8	£27.82
MMC10-1/2S-WD-SS	10	1/2	£36.57
MMC12-1/4S-WD-SS	12	1/4	£31.78
MMC12-3/8S-WD-SS	12	3/8	£29.71
MMC12-1/2S-WD-SS	12	1/2	£40.03
MMC14-3/8S-WD-SS	14	3/8	£36.18
MMC14-1/2S-WD-SS	14	1/2	£38.91
MMC16-3/8S-WD-SS	16	3/8	£48.45
MMC16-1/2S-WD-SS	16	1/2	£44.96
MMC16-3/4S-WD-SS	16	3/4	£60.07
MMC20-1/2S-WD-SS	20	1/2	£65.66
MMC20-3/4S-WD-SS	20	3/4	£59.66
MMC25-1/2S-WD-SS	25	1/2	£84.95
MMC25-3/4S-WD-SS	25	3/4	£97.37
MMC25-1S-WD-SS	25	1	£95.08
MMC30-1S-WD-SS	30	1	£127.73
MMC30-11/4S-WD-SS	30	1 1/4	£127.73
MMC38-11/4S-WD-SS	38	1 1/4	£156.82
MMC38-11/2S-WD-SS	38	1 1/2	£156.82



DIN 2353 Metric Stainless Steel Fittings

02

Male Stud Coupling

Form E
Metric Thread
WD Captive Seal
Light Series



PGC: 235	OD (mm)	Thread	Price
MMC6-M10L-WD-SS	6	M10 x 1	£18.66
MMC8-M12L-WD-SS	8	M12 x 1.5	£22.98
MMC10-M14L-WD-SS	10	M14 x 1.5	£22.76
MMC12-M16L-WD-SS	12	M16 x 1.5	£26.98
MMC12-M18L-WD-SS	12	M18 x 1.5	£28.44
MMC15-M22L-WD-SS	15	M22 x 1.5	£39.41
MMC18-M22L-WD-SS	18	M22 x 1.5	£43.01
MMC22-M26L-WD-SS	22	M26 x 1.5	£58.26
MMC28-M33L-WD-SS	28	M33 x 2	£83.58
MMC35-M42L-WD-SS	35	M42 x 2	£114.91
MMC42-M48L-WD-SS	42	M48 x 2	£140.87

Heavy Series

PGC: 235	OD (mm)	Thread	Price
MMC6-M12S-WD-SS	6	M12 x 1.5	£25.46
MMC8-M14S-WD-SS	8	M14 x 1.5	£27.29
MMC10-M16S-WD-SS	10	M16 x 1.5	£25.39
MMC12-M18S-WD-SS	12	M18 x 1.5	£30.14
MMC14-M20S-WD-SS	14	M20 x 1.5	£40.54
MMC20-M27S-WD-SS	20	M27 x 2	£67.98
MMC25-M33S-WD-SS	25	M33 x 2	£104.73
MMC30-M42S-WD-SS	30	M42 x 2	£123.27
MMC38-M48S-WD-SS	38	M48 x 2	£153.25

Male Stud Couplings NPT

Male Stud Coupling

Male Thread NPT
Light Light Series



PGC: 235	OD (mm)	NPT	Price
MMC4-1/8NLL-SS	4	1/8	£20.10
MMC6-1/8NLL-SS	6	1/8	£21.16
MMC8-1/8NLL-SS	8	1/8	£23.88

Light Series

PGC: 235	OD (mm)	NPT	Price
MMC6-1/8NL-SS	6	1/8	£19.79
MMC6-1/4NL-SS	6	1/4	£19.79
MMC8-1/8NL-SS	8	1/8	£19.15
MMC8-1/4NL-SS	8	1/4	£20.54
MMC10-1/4NL-SS	10	1/4	£24.87
MMC10-3/8NL-SS	10	3/8	£28.74
MMC12-1/4NL-SS	12	1/4	£28.22
MMC12-3/8NL-SS	12	3/8	£29.34
MMC12-1/2NL-SS	12	1/2	£30.98
MMC15-3/8NL-SS	15	3/8	£37.67
MMC15-1/2NL-SS	15	1/2	£39.31
MMC18-1/2NL-SS	18	1/2	£52.35
MMC22-3/4NL-SS	22	3/4	£65.04
MMC28-1NL-SS	28	1	£93.22
MMC35-11/4NL-SS	35	1 1/4	£126.27
MMC42-11/2NL-SS	42	1 1/2	£151.79

Heavy Series

PGC: 235	OD (mm)	NPT	Price
MMC6-1/8NS-SS	6	1/8	£21.61
MMC6-1/4NS-SS	6	1/4	£21.82
MMC10-1/4NS-SS	10	1/4	£30.36
MMC10-3/8NS-SS	10	3/8	£30.36
MMC12-1/4NS-SS	12	1/4	£31.53
MMC12-3/8NS-SS	12	3/8	£33.74
MMC12-1/2NS-SS	12	1/2	£31.53
MMC14-1/2NS-SS	14	1/2	£39.28
MMC16-1/2NS-SS	16	1/2	£52.72
MMC20-3/4NS-SS	20	3/4	£67.68
MMC25-1NS-SS	25	1	£116.11
MMC30-11/4NS-SS	30	1 1/4	£145.68
MMC38-11/2NS-SS	38	1 1/2	£201.81

Female Stud Couplings BSPP

Female Stud Coupling

Female Thread BSPP
Light Series



PGC: 235	OD (mm)	BSPP	Price
MFC6-1/8L-SS	6	1/8	£23.45
MFC8-1/4L-SS	8	1/4	£28.78
MFC8-3/8L-SS	8	3/8	£28.84
MFC8-1/2L-SS	8	1/2	£31.57
MFC10-1/4L-SS	10	1/4	£30.17
MFC10-3/8L-SS	10	3/8	£29.68
MFC10-1/2L-SS	10	1/2	£33.44
MFC12-3/8L-SS	12	3/8	£38.00
MFC12-1/2L-SS	12	1/2	£38.40
MFC15-1/2L-SS	15	1/2	£45.84
MFC18-1/2L-SS	18	1/2	£53.52
MFC22-3/4L-SS	22	3/4	£75.47
MFC28-1L-SS	28	1	£98.54
MFC35-11/4L-SS	35	1 1/4	£161.99
MFC42-11/2L-SS	42	1 1/2	£196.71

Heavy Series

PGC: 235	OD (mm)	BSPP	Price
MFC6-1/4S-SS	6	1/4	£30.37
MFC8-1/4S-SS	8	1/4	£28.45
MFC10-3/8S-SS	10	3/8	£39.36
MFC12-3/8S-SS	12	3/8	£40.31
MFC14-1/2S-SS	14	1/2	£46.10
MFC16-1/2S-SS	16	1/2	£54.20
MFC20-3/4S-SS	20	3/4	£87.14
MFC25-1S-SS	25	1	£98.21
MFC30-11/4S-SS	30	1 1/4	£179.74
MFC38-11/2S-SS	38	1 1/2	£219.45

Male Stud Elbows BSPT

Male Stud Elbow

Male Thread BSPT
Light Light Series



PGC: 235	OD (mm)	BSPT	Price
MME4-1/8TLL-SS	4	1/8	£29.78
MME6-1/8TLL-SS	6	1/8	£24.09
MME8-1/8TLL-SS	8	1/8	£31.52

Light Series

PGC: 235	OD (mm)	BSPT	Price
MME6-1/8TL-SS	6	1/8	£23.11
MME8-1/4TL-SS	8	1/4	£25.20
MME8-3/8TL-SS	8	3/8	£28.97
MME10-1/4TL-SS	10	1/4	£28.48
MME12-1/4TL-SS	12	1/4	£34.76
MME12-3/8TL-SS	12	3/8	£32.80
MME15-1/2TL-SS	15	1/2	£43.02
MME18-1/2TL-SS	18	1/2	£62.38
MME22-3/4TL-SS	22	3/4	£79.35
MME28-1TL-SS	28	1	£131.15

Heavy Series

PGC: 235	OD (mm)	BSPT	Price
MME6-1/4TS-SS	6	1/4	£27.97
MME8-1/4TS-SS	8	1/4	£33.60
MME10-3/8TS-SS	10	3/8	£29.71
MME12-3/8TS-SS	12	3/8	£39.32
MME14-1/2TS-SS	14	1/2	£49.61
MME16-1/2TS-SS	16	1/2	£73.24
MME20-3/4TS-SS	20	3/4	£82.73
MME25-1TS-SS	25	1	£193.42

Male Stud Elbows NPT

Male Stud Elbow

Male Thread NPT
Light Light Series



PGC: 235	OD (mm)	NPT	Price
MME6-1/8NLL-SS	6	1/8	£29.54

Light Series

PGC: 235	OD (mm)	NPT	Price
MME6-1/8NL-SS	6	1/8	£29.91
MME6-1/4NL-SS	6	1/4	£35.05
MME8-1/4NL-SS	8	1/4	£35.86
MME10-1/4NL-SS	10	1/4	£40.97
MME12-1/4NL-SS	12	1/4	£48.40
MME12-3/8NL-SS	12	3/8	£48.07
MME12-1/2NL-SS	12	1/2	£53.83
MME15-1/2NL-SS	15	1/2	£51.84
MME18-1/2NL-SS	18	1/2	£72.54
MME22-3/4NL-SS	22	3/4	£79.35
MME28-1NL-SS	28	1	£172.13

Heavy Series

PGC: 235	OD (mm)	NPT	Price
MME6-1/4NS-SS	6	1/4	£36.55
MME8-1/4NS-SS	8	1/4	£41.82
MME10-3/8NS-SS	10	3/8	£42.88
MME12-3/8NS-SS	12	3/8	£56.97
MME14-1/2NS-SS	14	1/2	£56.87
MME16-1/2NS-SS	16	1/2	£84.18
MME20-3/4NS-SS	20	3/4	£82.73
MME25-1NS-SS	25	1	£193.42



EMB-FS® Form & Seal System

02

- ▶ Standard parts according to DIN 2353 / ISO 8434-1
- ▶ High nominal pressures
- ▶ Low assembly power
- ▶ Approved for safety areas

Body DIN 2353, ISO 8434-1



Function Ring with vulcanized soft seal



Reshaped tube, standard hydraulic tube steel or stainless steel



Nut DIN 2353, ISO 8434-1



EMB-FS® tube-reshaping DIN 2353 tube fittings



Product Range and Materials

The EMB-FS® System provides the user with a reshaping system with the entire size spectrum of standard DIN 2353, ISO 8434-1 tube fittings.

- Full product range from 6 mm to 42 mm tube OD
- Use of all common materials, steel tubes St 37.4, stainless steel tubes 1.4571, zinc-chrome plated tubes and also special materials.



Technical Data

Width x Depth x Height	703 mm x 720 mm x 335 mm
Weight	145 kg
Power Supply	400 V
Frequency	50 Hz
Fuse	16 A

Cost and Time Savings

The specifications required of a tube forming system in terms of cost and time saving on the basis of DIN 2353 / ISO 8434-1 fittings are thus consistently fulfilled by EMB-FS®.

Significant cost savings due to reduction of the system / process costs.

- Does not require special tube preparation or finishing.
- Less single parts

Easy Assembly and High Performance during Operation

The final assembly of the tube in the connection body is done with the support of the function ring, which integrates an elastomer fine seal into the system and at the same time guarantees protection against excessive tightening by acting as an assembly limit.

- Frictional tension of tube and fitting cone with metallic sealfunction.
- The vulcanised soft seal guarantees leak-free performance in high pressure working conditions.
- Secure assembly by evident signalled assembly stop.

Economically Reshaping with the EMB-FS® Electronically Controlled Forming Machine

The standard hydraulic pipe in steel or stainless steel is formed in one step with the electronic power path controlled FS-forming machine

- Tube size selection can be performed quickly and simply via the machine display.
- The integrated power path control allows to process different materials, normal steel or stainless steel and also different tube wall thickness with one tool set.
- Tools can be changed very quickly and easily with the use of bayonet catch.
- Save of setup time and tool cost



Pipe OD x Wall Thickness (mm)	Clamping Jaws		Reshaper		Function Ring		Back-up Ring	
	Steel and Stainless Steel		Steel and Stainless Steel		Steel	Stainless Steel	Steel	Stainless Steel
	SPW...	FOW...	FSR..	FSR..	FSSR..	FSSR..	FSSR..	FSSR..
								
6 x 1	6 L/S	6 x 1-1.5 L/S	-		6 L/S	6 L/S - 1.4571		
6 x 1.5								
8 x 1	8 L/S	8 x 1-1.5 L/S	8 L/S	8 L/S - 1.4571	8 L/S	8 L/S - 1.4571	-	-
8 x 1.5								
8 x 2								
8 x 2.5								
8 x 3								
10 x 1	10 L/S	10 x 1-1.5 L	-	-	10 L/S	10 L/S - 1.4571	-	-
10 x 1.5								
10 x 2								
10 x 2.5								
10 x 3								
12 x 1	12 L/S	12 x 1-1.5 L/S	-	-	12 L/S	12 L/S - 1.4571	-	-
12 x 1.5								
12 x 2								
12 x 2.5								
12 x 3								
12 x 3.5	15	15 x 2	15	15 - 1.4571	15	15 - 1.4571		
15 x 2								
15 x 2.5								
15 x 3	16	16 x 2+	16	16 - 1.4571	16	16 - 1.4571		
16 x 2								
16 x 2.5								
16 x 3								
16 x 4	18	18 x 2	18	18 - 1.4751	18	18 - 1.4751		
18 x 2								
18 x 2.5								
18 x 3	20	20 x 2.5+	20	20 - 1.4571	20	20 - 1.4571		
20 x 2.5								
20 x 3								
20 x 3.5								
20 x 4								
22 x 2	22	22 x 2+	22	22 - 1.4571	22	22 - 1.4571		
22 x 2.5								
22 x 3								
22 x 3.5								
25 x 2.5	25	25 x 2.5+	25	25 - 1.4571	25	25 - 1.4571		
25 x 3								
25 x 3.5								
25 x 4								
25 x 4.5								
25 x 5								
28 x 2.5	28	28 x 2.5+	28	28 - 1.4571	28	28 - 1.4571		
28 x 3								
28 x 3.5								
28 x 4								
28 x 5								
30 x 3	30	30 x 3+	30	30 - 1.4571	30	30 - 1.4571		
30 x 4								
30 x 5								
30 x 6								
35 x 2.5								
35 x 3								
35 x 4								
35 x 5								
35 x 6								
38 x 3	38	38 x 3+	38	38 - 1.4571	38	38 - 1.4571		
38 x 4								
38 x 5								
38 x 6								
42 x 3								
42 x 3.5								
42 x 4								



Cross-section showing EMB-FS® components



EMB-FF10 Face Sealed (ORFS) Fittings System

02

The EMB-FF10 System is the EMB engineer's answer to the growing international market for ORFS fittings systems. As an Axial Faced Sealing System, it extends EMB's proven range of DIN fittings by adding a particularly practical design that is fully compliant with the international ISO 8434-3 standard.

Main Advantages of the EMB-FF10 System

- The EMB-FF10 System enables user-friendly assembly and simple re-assembly
- Compact assembly machine suits flexible and mobile on-site applications
- FF10-BU sleeve presses directly into the tube – no time-consuming preparation and finishing work required, and no costly soldering
- Use of approved and simple assembly machine UNIPRESS/M
- Minimal investment in machinery, since there is no need for expensive assembly machinery to create strong reshaped tube shapes
- Universal and rapid deployment solutions for everything from on-site repairs to small batch jobs
- Can be deployed with all standard strengths of tube wall for metric and imperial tube and hose connections



EMB-FF10 System Components

- ▶ Fitting body with O-ring (1) for faced sealing.
- ▶ O-ring (1) Standard NBR (e.g. Perbunan®) 90° Shore. Other material options are available.
- ▶ FF10-BU sleeve (2) An easy-to-use pre-assembly machine, e.g. UNIPRESS/M, can be used to press it into the tube and the tube will thus be flared to approximately 10°.
- ▶ FF10-KL support ring (3) ensures pipe is held securely.
- ▶ FF10-M nut (4).

Materials and Surfaces

Standard: Steel, Nut NanoProtect®, Support Ring bronzed.

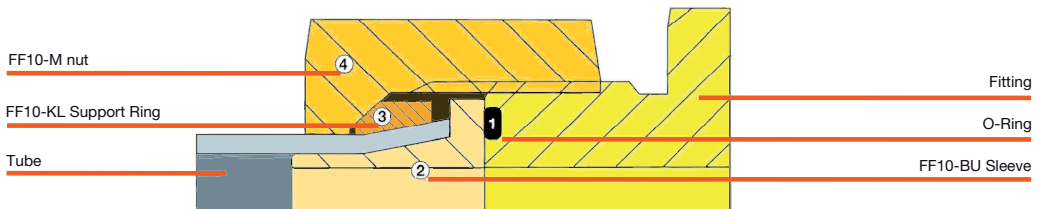
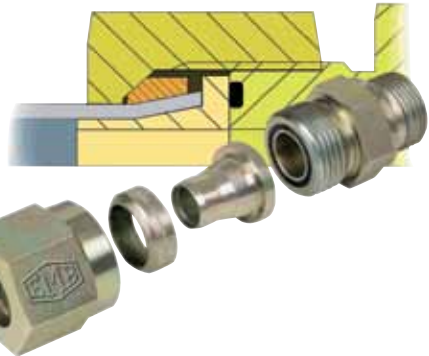

Perbunan® is a registered trademark of BAYER AG



Pre- & Final Assembly Machines

Final Assembly Saves Time and Money

The EMB patented technique of pre- and final assembly of cutting rings reduces assembly time and costs whilst providing superior "leak-free" characteristics and reliable, reproducible assembly results. EMB's SPS controlled assembly units provide outstanding functional and cost-effective performance.

Opticam, Type CAM 34
Final Pre-Assembling Machine for Cutting Rings



Unclean, Type TC 1036 S
Tube Rinsing Machine



The Opticam 34 is a hydraulically-powered machine for cutting-ring assembly with SPC control for final pre-assembly and, optionally, for pre-assembly of cutting rings.

The Opticam 34 can be used to produce all common assembly types.

- Fully automatic adjustment of programmes. When the counter plate is inserted, the programme is set by a 5-hole code. Validation checks are carried out by the Opticam's sensors.
- An alpha-numeric display shows all data necessary for the assembly. SPC (Storage-Programmable Control) allows for total supervision and control of the chosen kind of assembly.
- 100% assembly security by process control. Assembly programmes are supplied by EMB as software installations (but may also be determined by the machine operator); thus enabling the operator to produce assemblies with perfect precision and control. Assembly errors such as back-to-front cutting rings, deviation of dimensions in different parts, worn-out tooling and faulty tube preparation are identified and indicated on the display panel and by a red warning LED. Correct assembly is indicated by a green LED.
- The great advantage of this machine is the controlled final assembly of cutting rings. All that is required are cutting rings ready for final assembly, such as the EMB DS ring. Final assembly means that the cutting ring cuts into the tube by 100% while being controlled (control of pressure and distance). The final turning in the stud is only 30° (starting from pressure point).
- Controlled pre-assembly of cutting rings is possible (50% of the cutting-in process) for all standard kinds of cutting rings used throughout the industry.
- Users have the option of choosing up to 9 different programmes for cutting rings (1-9) via the keyboard. This means that it is possible to select from an enormous range of different kinds of assembly, materials, brands, etc.

Technical Data	
Max. mains air pressure:	18 bar (261 psi)
Min. mains air pressure:	6 bar (87 psi)
Max. working air pressure:	8 bar (116 psi)
Min. working air pressure:	2.5 (36 psi)
Average air requirement:	approx. 400 l/min
Pressure ration:	4 : 1
Max. working pressure (to the pistol):	32 bar (464 psi)
Air-feed amount (at 6 bar air pressure):	approx. 6 l/min
Allowed tank filling volume:	max. 30 l
Dimensions:	W 380 mm
	H 500 mm
	D 640 mm
Weight (without contents):	approx. 30 kg



Unipress 3, Type UP 3

Universal Machine for Flaring and Cutting Ring Pre-Assembly



Combination machine for cutting ring pre-assembly (all makes and materials) with manual or automatic pressure setting and pipe flaring for steel and stainless steel pipes with an outside diameter of 6 mm - 42 mm.

Technical Data:

Working pressure: from 0 bar to 250 bar (3625 psi)
 Operating voltage: 400 V / 50 Hz / 3-phases
 Weight: ca. 85 kg
 Dimensions: H 500 mm
 D 650 mm
 W 450 mm

1. Pipe flaring

- Flaring is done at a 37° angle / DIN EMB ABO and SAE System
- Flaring assembly unit 37° UP 3 for mechanical clamping flaring tools type UNI-BBO or UNI-BB
- Flaring assembly unit for hydraulically clamping flaring tools, type UNI-BBO 3

2. Cutting-ring pre-assembling

Cutting-ring pre-assembly with fully automatic pressure setting (controlled by the counter plates) with the option of manually setting the pressure.

Unipress, Type UP/M

Hand Assembly Machine



For Cutting Ring Pre-Assembly, 37° Flaring and FF10

The hand-assembly machine, type UP/M, is a universal machine designed for the following applications:

1. Pre-assembly of cutting rings (all kinds of brand) Ø 6 mm - 42 mm. The tools needed are the same as those used for the electro-hydraulic machines (assembly studs OPTI... and counter plated OPT/...).
2. Tube flaring for 37° EMB ABO and SAE system, Ø 6 mm - 22 mm. Tools: dies UNI-BBO... for EMB ABO-adaptor system UNI-BB... for SAE-System.
3. Tube flaring for EMB FF10.

Tooling:

- device for flaring (BVUPM622)
- pressure plate (DT ...)
- dies (UNI-BBZ ...)

Optigrat, Type OG 642

Tube Deburring Machine



For tube diameters from 6 mm - 42 mm

The Optigrat 642 deburring device is made out of HSS steel to ensure mark-free deburring and extremely long tool life.

Rotational speed of tools:

- inner deburring 300 rpm
- outer deburring 200 rpm
- weight: 30 kg
- dimensions: H 225 mm
W 492 mm
D 333 mm

Unicut, Type TC 080

Tube Deburring Machine



Compact transportable hand circular saw for universal usage.

Cutting Section:

<	□	○	□	●	■
90°	80	70	95x60	40	40
45°	70	60	65x60	40	40

- straight and mitring cutting up to 45° left
Motor: 380 V/50 Hz/3-phases – 1.0 kW
alternative 220 V – 0.8 kW
 - integrated automatic cooler
 - rotational speed: 52 rpm
 - dimensions: 70 x 45 x 85 cm
 - weight: 71 kg
- Saw blades in mat. HSS with surface-coating DMO, 250 x 2.0 x 32 with 2 side holes 12 mm / 64 mm:

- 128 teeth for thick-walled profiles and solid materials, order-no. HSS saw blade 250 / 128
- 200 teeth for thin-walled profiles and tubes, order-no. HSS saw blade 250 / 200

A Synergy of Hydraulic Experts

02

Extension of the Integrated Approach

With the addition of the EMB product family, Gates has now taken its Integrated System Approach to the next level where hose assemblies, adaptors, fittings and tube forming systems are designed together to obtain truly leak-free port-to-port solutions. The combined expertise of Gates and EMB offer port-to-port solutions throughout mobile industrial applications.

Technical Leadership

Both Gates and EMB have a long tradition of innovation and technical leadership. With the combination of hose specialists and metal designers Gates is determined to continue this tradition and to increase the speed of innovation and the commercialisation of new products.

Factory Quality through Simple Solutions

The transparency of the Gates no-skive coupling range, the simplicity of its constant pressure hose range, the ease of EMB's FS® tube forming machine, ...

These are just a few examples of both Gates' and EMB's objectives: factory quality products within everyone's reach!



Application Support from Port to Port

Gates Application Engineers are always at your service and will now review complete hydraulic port-to-port connections! The combination of their outstanding experience with high performing Gates and EMB product ranges are your guarantee for the best possible total solution!



A Tomkins Company





A Tomkins Company

MegaCrimp® Hydraulic Hose Couplings

02

Gates' innovative no-skive couplings for wire-braid hose construction. MegaCrimp® couplings are low profile, fully-qualified EN-performance couplings featuring full stem insertion and full length crimp.

One MegaCrimp® fits the entire range of Gates wire-braid hoses, one size can accommodate various hose ODs. Gates' exclusive TuffCoat® plating gives 400 hours of red rust corrosion protection when subjected to rigorous SAE-J516 and ASTM-P-117 salt-spray conditions.

Features	Benefits
Works with all Gates wire braid hoses	Versatility — simplifies inventory management
No-skive assembly; no tooling required	Reduces labour, assembly time and errors
One-piece no-skive coupling	Eliminates risk of contamination inside the hose
Robust "Bite the wire" crimp	Excellent coupling retention
Unique and patented "C" insert	Ensures a concentric and full length crimp
Tested to 600,000 impulse cycles	Extended coupling Life

BSP Couplings

Female BSP Coupling

O-Ring Seal
60° Cone



PGC: 375	ID (")	BSP	Price
4G4FBSPORX	1/4	1/4	£5.45
4G6FBSPORX	1/4	3/8	£5.45
5G6FBSPORX	5/16	3/8	£7.71
5G8FBSPORX	5/16	1/2	£9.54
6G6FBSPORX	3/8	3/8	£5.77
6G8FBSPORX	3/8	1/2	£6.30
8G6FBSPORX	1/2	3/8	£9.45
8G8FBSPORX	1/2	1/2	£7.06
8G10FBSPORX	1/2	5/8	£15.22
8G12FBSPORX	1/2	3/4	£24.17
10G10FBSPORX	5/8	5/8	£10.48
10G12FBSPORX	5/8	3/4	£13.01
12G12FBSPORX	3/4	3/4	£13.67
12G16FBSPORX	3/4	1	£25.01
16G12FBSPORX	1	3/4	£57.45
16G16FBSPORX	1	1	£18.69

Female Coupling 45° Swept Elbow

O-Ring Seal
60° Cone



PGC: 375	ID (")	BSP	Price
4G4FBSPORX45	1/4	1/4	£10.60
4G6FBSPORX45	1/4	3/8	£13.35
5G6FBSPORX45	5/16	3/8	£13.48
6G6FBSPORX45	3/8	3/8	£10.44
6G8FBSPORX45	3/8	1/2	£14.24
8G8FBSPORX45	1/2	1/2	£12.65
8G10FBSPORX45	1/2	5/8	£23.10
10G10FBSPORX45	5/8	5/8	£17.34
10G12FBSPORX45	5/8	3/4	£29.02
12G12FBSPORX45	3/4	3/4	£21.43
16G16FBSPORX45	1	1	£35.47

Female BSP Coupling 90° Swept Elbow

O-Ring Seal
60° Cone



PGC: 375	ID (")	BSP	Price
4G4FBSPORX90	1/4	1/4	£10.00
4G6FBSPORX90	1/4	3/8	£10.27
5G6FBSPORX90	5/16	3/8	£13.48
6G6FBSPORX90	3/8	3/8	£10.15
6G8FBSPORX90	3/8	1/2	£13.20
8G8FBSPORX90	1/2	1/2	£12.29
8G10FBSPORX90	1/2	5/8	£23.42
10G10FBSPORX90	5/8	5/8	£17.59
10G12FBSPORX90	5/8	3/4	£29.39
12G12FBSPORX90	3/4	3/4	£21.47
12G16FBSPORX90	3/4	1	£39.10
16G12FBSPORX90	1	3/4	£56.93
16G16FBSPORX90	1	1	£35.47

Female BSP Coupling

Flat Face



PGC: 375	ID (")	BSP	Price
5G8FBFFX	5/16	1/2	£28.43
6G6FBFFX	3/8	3/8	£14.26
6G8FBFFX	3/8	1/2	£9.23
8G8FBFFX	1/2	1/2	£9.81
8G10FBFFX	1/2	5/8	£32.13
8G12FBFFX	1/2	3/4	£27.12
10G12FBFFX	5/8	3/4	£17.57
12G12FBFFX	3/4	3/4	£18.77

Female BSPP Coupling

90° Block Elbow

O-Ring Seal
60° Cone



PGC: 375	ID (")	BSPP	Price
4G4FBSPORX90BL	1/4	1/4	£10.61
4G6FBSPORX90BL	1/4	3/8	£14.48
6G6FBSPORX90BL	3/8	3/8	£12.88
6G8FBSPORX90BL	3/8	1/2	£16.27
8G8FBSPORX90BL	1/2	1/2	£16.02
8G10FBSPORX90BL	1/2	5/8	£28.59
10G10FBSPORX90BL	5/8	5/8	£36.09
12G12FBSPORX90BL	3/4	3/4	£25.78
16G12FBSPORX90BL	1	3/4	£51.37
16G16FBSPORX90BL	1	1	£37.00

Male BSPP Coupling

60° Inverted Cone



PGC: 375	ID (")	BSP	Price
4G4MBSPP	1/4	1/4	£7.23
4G6MBSPP	1/4	3/8	£7.92
4G8MBSPP	1/4	1/2	£9.43
5G4MBSPP	5/16	1/4	£22.72
6G6MBSPP	3/8	3/8	£6.29
6G8MBSPP	3/8	1/2	£8.95
8G6MBSPP	1/2	3/8	£11.51
8G8MBSPP	1/2	1/2	£7.91
8G10MBSPP	1/2	5/8	£26.30
10G10MBSPP	5/8	5/8	£14.59
10G12MBSPP	5/8	3/4	£15.69
12G12MBSPP	3/4	3/4	£14.23
16G16MBSPP	1	1	£24.61

Male BSPT Coupling



PGC: 375	ID (")	BSPT	Price
4G4MBSPT	1/4	1/4	£7.39
4G6MBSPT	1/4	3/8	£12.29
5G6MBSPT	5/16	3/8	£12.78
6G6MBSPT	3/8	3/8	£7.16
6G8MBSPT	3/8	1/2	£14.24
8G6MBSPT	1/2	3/8	£15.69
8G8MBSPT	1/2	1/2	£9.67
10G10MBSPT	5/8	5/8	£21.34
12G12MBSPT	3/4	3/4	£18.35
16G16MBSPT	1	1	£32.07

BSPP Bulkhead

Male thread BSPP
60° Inverted cone



PGC: 375	ID (")	BSPP	Price
4G4MBSPPBKHD	1/4	1/4	£29.08
6G6MBSPPBKHD	3/8	3/8	£36.68
8G8MBSPPBKHD	1/2	1/2	£45.88
10G10MBSPPBKHD	5/8	5/8	£55.16
16G16MBSPPBKHD	1	1	£73.63

Male Banjo Coupling

BSP Banjo



PGC: 375	ID (")	BSP	Price
4G4BSPBJ	1/4	1/4	£13.26
4G6BSPBJ	1/4	3/8	£34.97
6G4BSPBJ	3/8	1/4	£34.29
6G6BSPBJ	3/8	3/8	£17.54
6G8BSPBJ	3/8	1/2	£34.29
8G8BSPBJ	1/2	1/2	£41.72
12G12BSPBJ	3/4	3/4	£61.17

NPT Couplings

Pipe Swivel

Female Thread NPT
30° Cone



PGC: 375	ID (")	NPT	Price
4G4FPX	1/4	1/4	£11.00
6G6FPX	3/8	3/8	£15.17
8G8FPX	1/2	1/2	£16.58
12G12FPX	3/4	3/4	£20.77
16G16FPX	1	1	£30.40

Pipe Coupling

Male Thread NPT



PGC: 375	ID (")	NPT	Price
4G2MP	1/4	1/8	£8.28
4G4MP	1/4	1/4	£6.45
4G6MP	1/4	3/8	£7.91
4G8MP	1/4	1/2	£8.90
5G4MP	5/16	1/4	£13.64
5G6MP	5/16	3/8	£12.33
6G4MP	3/8	1/4	£9.30
6G6MP	3/8	3/8	£7.17
6G8MP	3/8	1/2	£9.91
8G6MP	1/2	3/8	£10.60
8G8MP	1/2	1/2	£9.43
8G12MP	1/2	3/4	£44.01
10G8MP	5/8	1/2	£17.86
10G12MP	5/8	3/4	£17.17
12G8MP	3/4	1/2	£19.40
12G12MP	3/4	3/4	£15.12
12G16MP	3/4	1	£19.81
16G12MP	1	3/4	£23.05
16G16MP	1	1	£21.34

Long Nose Pipe Coupling

Male Thread NPT



PGC: 375	ID (")	NPT	Price
4G4MPLN	1/4	1/4	£82.86
4G6MPLN	1/4	3/8	£8.00
6G4MPLN	3/8	1/4	£40.06
6G6MPLN	3/8	3/8	£11.58

Pipe Swivel

90° Block Elbow
Male Thread NPT



PGC: 375	ID (")	NPT	Price
4G4MPX90	1/4	1/4	£15.82
4G6MPX90	1/4	3/4	£18.48
6G4MPX90	3/8	1/4	£22.51
6G6MPX90	3/8	3/4	£26.70
6G8MPX90	3/8	1/2	£31.30
8G6MPX90	1/2	3/8	£26.41
8G8MPX90	1/2	1/2	£21.31
12G12MPX90	3/4	3/4	£59.47

DIN Couplings

Male DIN Coupling

O-Ring Seal
24° Inverted Cone
Light Series



PGC: 375	ID (")	Thread	Price
4G6MDL	1/4	M12 x 1.5	£7.10
4G8MDL	1/4	M14 x 1.5	£7.98
4G10MDL	1/4	M16 x 1.5	£11.68
4G12MDL	1/4	M18 x 1.5	£13.86
5G8MDL	5/16	M14 x 1.5	£12.60
5G10MDL	5/16	M16 x 1.5	£6.83
5G12MDL	5/16	M18 x 1.5	£14.97
6G10MDL	3/8	M16 x 1.5	£7.98
6G12MDL	3/8	M18 x 1.5	£7.92
6G15MDL	3/8	M22 x 1.5	£9.93
8G12MDL	1/2	M18 x 1.5	£12.42
8G15MDL	1/2	M22 x 1.5	£8.61
8G18MDL	1/2	M26 x 1.5	£16.85
10G18MDL	5/8	M26 x 1.5	£11.94
12G18MDL	3/4	M26 x 1.5	£13.48
12G22MDL	3/4	M30 x 2	£16.25
16G28MDL	1	M36 x 2	£29.07

Heavy Series

PGC: 375	ID (")	Thread	Price
4G8MDH	1/4	M16 x 1.5	£13.08
4G10MDH	1/4	M18 x 1.5	£13.06
5G10MDH	5/16	M18 x 1.5	£12.58
5G12MDH	5/16	M20 x 1.5	£13.55
6G10MDH	3/8	M18 x 1.5	£9.75
6G12MDH	3/8	M20 x 1.5	£8.32
6G14MDH	3/8	M22 x 1.5	£9.48
8G12MDH	1/2	M20 x 1.5	£40.67
8G16MDH	1/2	M24 x 1.5	£11.08
10G20MDH	5/8	M30 x 2	£15.58
12G20MDH	3/4	M30 x 2	£26.14
12G25MDH	3/4	M36 x 2	£25.12
16G25MDH	1	M36 x 2	£68.98
16G30MDH	1	M42 x 2	£34.36

DIN Standpipe Coupling



PGC: 375	ID (")	OD (mm)	Price
4G6MSP	1/4	6	£6.65
4G8MSP	1/4	8	£6.78
4G10MSP	1/4	10	£6.65
5G8MSP	5/16	8	£16.42
5G10MSP	5/16	10	£7.68
5G12MSP	5/16	12	£8.12
6G10MSP	3/8	10	£6.06
6G12MSP	3/8	12	£5.98
8G15MSP	1/2	15	£8.68
10G18MSP	5/8	18	£11.20
12G22MSP	3/4	22	£14.38

Female DIN Coupling

O-Ring Seal
24° Cone
Light Series



PGC: 375	ID (")	NPT	Price
4G6FDLORX	1/4	M12 x 1.5	£10.25
4G8FDLORX	1/4	M14 x 1.5	£5.66
4G10FDLORX	1/4	M16 x 1.5	£6.57
4G12FDLORX	1/4	M18 x 1.5	£9.11
5G8FDLORX	5/16	M14 x 1.5	£11.99
5G10FDLORX	5/16	M16 x 1.5	£6.76
5G12FDLORX	5/16	M18 x 1.5	£8.23
6G10FDLORX	3/8	M16 x 1.5	£7.86
6G12FDLORX	3/8	M18 x 1.5	£6.21
6G14FDLORX	3/8	M20 x 1.5	£8.93
8G12FDLORX	1/2	M18 x 1.5	£14.25
8G15FDLORX	1/2	M22 x 1.5	£8.81
8G18FDLORX	1/2	M26 x 1.5	£21.40
10G18FDLORX	5/8	M26 x 1.5	£11.93
12G18FDLORX	3/4	M26 x 1.5	£34.04
12G22FDLORX	3/4	M30 x 2	£15.46
16G28FDLORX	1	M36 x 2	£27.52

Heavy Series

PGC: 375	ID (")	NPT	Price
4G6FDHORX	1/4	M14 x 1.5	£8.83
4G8FDHORX	1/4	M16 x 1.5	£7.02
4G10FDHORX	1/4	M18 x 1.5	£7.51
4G12FDHORX	1/4	M20 x 1.5	£8.18
5G10FDHORX	5/16	M18 x 1.5	£8.35
5G12FDHORX	5/16	M20 x 1.5	£7.77
5G14FDHORX	5/16	M22 x 1.5	£44.42
6G10FDHORX	3/8	M18 x 1.5	£11.08
6G12FDHORX	3/8	M20 x 1.5	£7.61
6G14FDHORX	3/8	M22 x 1.5	£9.04
8G12FDHORX	1/2	M20 x 1.5	£12.26
8G14FDHORX	1/2	M22 x 1.5	£40.67
8G16FDHORX	1/2	M24 x 1.5	£10.26
8G20FDHORX	1/2	M30 x 2	£34.50
10G16FDHORX	5/8	M24 x 1.5	£27.37
10G20FDHORX	5/8	M30 x 2	£15.34
12G20FDHORX	3/4	M30 x 2	£29.61
12G25FDHORX	3/4	M36 x 2	£22.51
16G25FDHORX	1	M36 x 2	£37.69
16G30FDHORX	1	M42 x 2	£35.33

Female DIN Coupling

45° Swept Elbow
O-Ring Seal
24° Cone
Light Series



PGC: 375	ID (")	Thread	Price
4G6FDLORX45	1/4	M12 x 1.5	£19.76
4G8FDLORX45	1/4	M14 x 1.5	£10.61
4G10FDLORX45	1/4	M16 x 1.5	£13.74
4G12FDLORX45	1/4	M18 x 1.5	£15.37
5G8FDLORX45	5/16	M14 x 1.5	£26.21
5G10FDLORX45	5/16	M16 x 1.5	£11.00
5G12FDLORX45	5/16	M18 x 1.5	£16.37
6G10FDLORX45	3/8	M16 x 1.5	£14.26
6G12FDLORX45	3/8	M18 x 1.5	£10.83
6G15FDLORX45	3/8	M22 x 1.5	£16.43
8G12FDLORX45	1/2	M18 x 1.5	£28.03
8G15FDLORX45	1/2	M22 x 1.5	£13.69
8G18FDLORX45	1/2	M26 x 1.5	£13.69
10G18FDLORX45	5/8	M26 x 1.5	£20.05

Heavy Series

PGC: 375	ID (")	Thread	Price
4G8FDHORX45	1/4	M16 x 1.5	£14.62
4G10FDHORX45	1/4	M18 x 1.5	£13.40
4G12FDHORX45	1/4	M20 x 1.5	£11.43
5G10FDHORX45	5/16	M18 x 1.5	£19.38
5G12FDHORX45	5/16	M20 x 1.5	£15.44
6G10FDHORX45	3/8	M18 x 1.5	£21.13
6G12FDHORX45	3/8	M20 x 1.5	£12.72
6G14FDHORX45	3/8	M22 x 1.5	£34.79
8G14FDHORX45	1/2	M22 x 1.5	£56.93
8G16FDHORX45	1/2	M24 x 1.5	£17.33
10G20FDHORX45	5/8	M30 x 2	£29.10
12G20FDHORX45	3/4	M30 x 2	£53.03
12G25FDHORX45	3/4	M36 x 2	£47.44
16G25FDHORX45	1	M36 x 2	£62.65
16G30FDHORX45	1	M42 x 2	£67.34

Female DIN Coupling

90° Swept Elbow
O-Ring Seal
24° Cone
Light Series



PGC: 375	ID (")	Thread	Price
4G6FDLORX90	1/4	M12 x 1.5	£16.65
4G8FDLORX90	1/4	M14 x 1.5	£10.61
4G10FDLORX90	1/4	M16 x 1.5	£12.22
4G12FDLORX90	1/4	M18 x 1.5	£16.09
5G8FDLORX90	5/16	M14 x 1.5	£17.72
5G10FDLORX90	5/16	M16 x 1.5	£11.84
5G12FDLORX90	5/16	M18 x 1.5	£14.82
6G10FDLORX90	3/8	M16 x 1.5	£14.26
6G12FDLORX90	3/8	M18 x 1.5	£11.61
6G15FDLORX90	3/8	M22 x 1.5	£17.40
8G12FDLORX90	1/2	M18 x 1.5	£27.10
8G15FDLORX90	1/2	M22 x 1.5	£14.55
8G18FDLORX90	1/2	M26 x 1.5	£41.70
10G18FDLORX90	5/8	M26 x 1.5	£19.48
12G18FDLORX90	3/4	M26 x 1.5	£68.02
12G22FDLORX90	3/4	M30 x 2	£25.53
16G28FDLORX90	1	M36 x 2	£51.32

Heavy Series

PGC: 375	ID (")	Thread	Price
4G6FDHORX90	1/4	M14 x 1.5	£14.01
4G8FDHORX90	1/4	M16 x 1.5	£11.97
4G10FDHORX90	1/4	M18 x 1.5	£11.82
4G12FDHORX90	1/4	M20 x 1.5	£11.43
5G10FDHORX90	5/16	M18 x 1.5	£18.09
5G12FDHORX90	5/16	M20 x 1.5	£13.56
5G14FDHORX90	5/16	M22 x 1.5	£48.80
6G10FDHORX90	3/8	M18 x 1.5	£19.98
6G12FDHORX90	3/8	M20 x 1.5	£12.72
6G14FDHORX90	3/8	M22 x 1.5	£22.11
8G16FDHORX90	1/2	M24 x 1.5	£17.33
10G20FDHORX90	5/8	M30 x 2	£25.86
12G20FDHORX90	3/4	M30 x 2	£53.03
12G25FDHORX90	3/4	M36 x 2	£35.94
16G25FDHORX90	1	M36 x 2	£62.65
16G30FDHORX90	1	M42 x 2	£63.66

JIC Couplings

Male JIC Coupling

37° Cone



PGC: 375	ID (")	UNF	Price
4G4MJ	1/4	7/16 - 20	£6.05
4G5MJ	1/4	1/2 - 20	£7.67
4G6MJ	1/4	9/16 - 18	£7.43
5G5MJ	5/16	1/2 - 20	£8.61
5G6MJ	5/16	9/16 - 18	£7.56
6G6MJ	3/8	9/16 - 18	£6.22
6G8MJ	3/8	3/4 - 16	£7.39
6G10MJ	3/8	7/8 - 14	£11.47
8G8MJ	1/2	3/4 - 16	£8.02
8G10MJ	1/2	7/8 - 14	£9.13
8G12MJ	1/2	1 1/16 - 12	£16.12
10G8MJ	5/8	3/4 - 16	£30.81
10G10MJ	5/8	7/8 - 14	£12.50
10G12MJ	5/8	1 1/16 - 12	£15.19
12G12MJ	3/4	1 1/16 - 12	£14.00
12G14MJ	3/4	1 3/16 - 12	£23.71
12G16MJ	3/4	1 5/16 - 12	£20.07
16G16MJ	1	1 5/16 - 12	£20.40

Female JIC Swivel

37° Inverted Cone



PGC: 375	ID (")	UNF	Price
4G4FJX	1/4	7/16-20	£5.52
4G5FJX	1/4	1/2-20	£8.61
4G6FJX	1/4	9/16-18	£6.71
5G5FJX	5/16	1/2-20	£10.71
5G6FJX	5/16	9/16-18	£10.92
6G4FJX	3/8	7/16-20	£24.01
6G5FJX	3/8	1/2-20	£22.71
6G6FJX	3/8	9/16-18	£5.69
6G8FJX	3/8	3/4-16	£7.79
6G10FJX	3/8	7/8-14	£11.71
8G6FJX	1/2	9/16-18	£10.71
8G8FJX	1/2	3/4-16	£7.69
8G10FJX	1/2	7/8-14	£10.75
8G12FJX	1/2	1 1/16-12	£15.27
10G8FJX	5/8	1 3/16-12	£20.58
10G10FJX	5/8	7/8-14	£10.73
10G12FJX	5/8	1 1/16-12	£14.81
10G14FJX	5/8	1 3/16-12	£32.09
12G10FJX	3/4	7/8-14	£16.65
12G12FJX	3/4	1 1/16-12	£13.75
12G14FJX	3/4	1 3/16-12	£20.27
12G16FJX	3/4	1 5/16-12	£25.12
16G12FJX	1	1 1/16-12	£43.07
16G14FJX	1	1 3/16-12	£35.32
16G16FJX	1	1 5/16-12	£20.44

Female JIC Swivel

90° Swept Elbow
37° Inverted Cone
Short Drop to ISO 12151-5



PGC: 375	ID (")	Thread	Price
4G4FJX90S	1/4	7/16 - 20 UNF	£10.36
4G6FJX90S	1/4	9/16 - 18 UNF	£10.72
5G6FJX90S	5/16	9/16 - 18 UNF	£46.46
6G6FJX90S	3/8	9/16 - 18 UNF	£10.03
6G8FJX90S	3/8	3/4 - 16 UNF	£12.52
8G8FJX90S	1/2	3/4 - 16 UNF	£11.87
8G10FJX90S	1/2	7/8 - 14 UNF	£16.30
8G12FJX90S	1/2	1 1/16 - 12 UN	£40.21
10G12FJX90S	5/8	1 1/16 - 12 UN	£20.26
12G12FJX90S	3/4	1 1/16 - 12 UN	£21.37
16G16FJX90S	1	1 5/16 - 12 UN	£31.97

Medium Drop to ISO 12151-5

PGC: 375	ID (")	UNF	Price
4G4FJX90M	1/4	7/16-20	£10.71
4G5FJX90M	1/4	1/2-20	£14.48
4G6FJX90M	1/4	9/16-18	£13.60
5G5FJX90M	5/16	1/2-20	£18.90
5G6FJX90M	5/16	9/16-18	£12.57
6G6FJX90M	3/8	9/16-18	£10.35
6G8FJX90M	3/8	3/4-16	£12.84
8G8FJX90M	1/2	3/4-16	£12.26
8G10FJX90M	1/2	7/8-14	£16.81
10G10FJX90M	5/8	7/8-14	£16.98
10G12FJX90M	5/8	1 1/16-12	£20.86
12G10FJX90M	3/4	7/8-14	£66.59
12G12FJX90M	3/4	1 1/16-12	£22.05
16G16FJX90M	1	1 5/16-12	£32.98

Long Drop to ISO 12151-5

PGC: 375	ID (")	UNF	Price
4G4FJX90L	1/4	7/16 - 20 UNF	£14.39
6G6FJX90L	3/8	9/16 - 18 UNF	£11.91
6G8FJX90L	3/8	3/4 - 16 UNF	£22.65
8G8FJX90L	1/2	3/4 - 16 UNF	£16.50
8G10FJX90L	1/2	7/8 - 14 UNF	£19.35
10G10FJX90L	5/8	7/8 - 14 UNF	£29.98
10G12FJX90L	5/8	1 1/16 - 12 UN	£43.68
12G12FJX90L	3/4	1 1/16 - 12 UN	£25.36
16G16FJX90L	1	1 5/16 - 12 UN	£37.92

Female JIC Swivel

45° Swept Elbow
37° Inverted Cone



PGC: 375	ID (")	Thread	Price
4G4FJX45	1/4	7/16 - 20 UNF	£10.71
4G5FJX45	1/4	1/2 - 20 UNF	£13.98
4G6FJX45	1/4	9/16 - 18 UNF	£9.82
5G5FJX45	5/16	1/2 - 20 UNF	£35.27
5G6FJX45	5/16	9/16 - 18 UNF	£11.82
6G6FJX45	3/8	9/16 - 18 UNF	£9.67
6G8FJX45	3/8	3/4 - 16 UNF	£12.44
8G8FJX45	1/2	3/4 - 16 UNF	£12.44
8G10FJX45	1/2	7/8 - 14 UNF	£12.60
10G10FJX45	5/8	7/8 - 14 UNF	£15.78
10G12FJX45	5/8	1 1/16 - 12 UN	£14.46
12G10FJX45	3/4	7/8 - 14 UNF	£14.46
12G12FJX45	3/4	1 1/16 - 12 UN	£19.41
12G16FJX45	3/4	1 5/16 - 12 UN	£78.18
16G16FJX45	1	1 5/16 - 12 UN	£21.69

Metric DBJ Couplings

Banjo



PGC: 375	ID (")	Thread	Price
4G10DBJ	1/4	M10	£13.26
4G12DBJ	1/4	M12	£13.10
4G14DBJ	1/4	M14	£14.00
4G16DBJ	1/4	M16	£18.24
4G18DBJ	1/4	M18	£36.36
5G12DBJ	5/16	M12	£19.16
5G14DBJ	5/16	M14	£16.30
5G16DBJ	5/16	M16	£19.57
5G18DBJ	5/16	M18	£38.34
6G14DBJ	3/8	M14	£21.24
6G16DBJ	3/8	M16	£17.54
6G18DBJ	3/8	M18	£34.97
6G22DBJ	3/8	M22	£36.58
8G18DBJ	1/2	M18	£22.19
8G22DBJ	1/2	M22	£36.55
10G22DBJ	5/8	M22	£48.25
12G26DBJ	3/4	M26	£77.15
16G30DBJ	1	M30	£86.03

ORFS Couplings

Male ORFS Coupling

Flat Face O-Ring Seal



PGC: 375	ID (")	Thread	Price
4G4MFFOR	1/4	9/16 - 18 UNF	£20.24
4G6MFFOR	1/4	11/16 - 16 UN	£26.04
6G6MFFOR	3/8	11/16 - 16 UN	£15.28
6G8MFFOR	3/8	13/16 - 16 UN	£27.78
6G10MFFOR	3/8	1 - 14 UNS	£36.17
8G8MFFOR	1/2	13/16 - 16 UN	£18.54
8G10MFFOR	1/2	1 - 14 UNS	£24.65
10G10MFFOR	5/8	1 - 14 UNS	£23.25
10G12MFFOR	5/8	1 3/16 - 12 UN	£30.24
12G12MFFOR	3/4	1 3/16 - 12 UN	£24.44
12G16MFFOR	3/4	1 7/16 - 12 UN	£35.86
16G16MFFOR	1	1 7/16 - 12 UN	£25.75

Female ORFS Coupling

Flat Face O-Ring Seal



PGC: 375	ID (")	Thread	Price
4G4FFORX	1/4	9/16 - 18 UNF	£7.83
4G6FFORX	1/4	11/16 - 16 UN	£11.32
5G6FFORX	5/16	11/16 - 16 UN	£11.64
6G4FFORX	3/8	9/16 - 18 UNF	£19.15
6G6FFORX	3/8	13/16 - 16 UN	£9.57
6G8FFORX	3/8	13/16 - 16 UN	£10.82
8G6FFORX	1/2	11/16 - 16 UN	£19.40
8G8FFORX	1/2	13/16 - 16 UN	£11.27
8G10FFORX	1/2	1 - 14 UNS	£19.68
8G12FFORX	1/2	1 3/16 - 12 UN	£32.83
10G10FFORX	5/8	1 - 14 UNS	£14.33
10G12FFORX	5/8	1 3/16 - 12 UN	£33.39
12G10FFORX	3/4	1 - 14 UNS	£41.20
12G12FFORX	3/4	1 3/16 - 12 UN	£21.15
12G16FFORX	3/4	1 7/16 - 12 UN	£26.33
16G16FFORX	1	1 7/16 - 12 UN	£31.13

Female ORFS Coupling

45° Swept Elbow
Flat Face O-Ring Seal



PGC: 375	ID (")	Thread	Price
4G4FFORX45	1/4	9/16 - 18 UNF	£11.52
4G6FFORX45	1/4	11/16 - 16 UN	£13.77
5G6FFORX45	5/16	11/16 - 16 UN	£22.65
6G6FFORX45	3/8	11/16 - 16 UN	£12.72
6G8FFORX45	3/8	13/16 - 16 UN	£15.84
8G8FFORX45	1/2	13/16 - 16 UN	£14.61
8G10FFORX45	1/2	1 - 14 UNS	£23.77
10G10FFORX45	5/8	1 - 14 UNS	£27.28
10G12FFORX45	5/8	1 3/16 - 12 UN	£29.14
12G10FFORX45	3/4	1 - 14 UNS	£49.06
12G12FFORX45	3/4	1 3/16 - 12 UN	£26.47
12G16FFORX45	3/4	1 7/16 - 12 UN	£47.26
16G16FFORX45	1	1 7/16 - 12 UN	£35.28

Female ORFS Coupling

90° Swept Elbow
Flat Face O-Ring Seal
Short Drop to ISO 12151-1



PGC: 375	ID (")	Thread	Price
4G4FFORX90S	1/4	9/16 - 18 UNF	£15.32
4G6FFORX90S	1/4	11/16 - 16 UN	£13.36
5G6FFORX90S	5/16	11/16 - 16 UN	£23.10
6G4FFORX90S	3/8	9/16 - 18 UNF	£20.66
6G6FFORX90S	3/8	11/16 - 16 UN	£12.80
6G8FFORX90S	3/8	13/16 - 16 UN	£15.83
8G6FFORX90S	1/2	11/16 - 16 UN	£42.50
8G8FFORX90S	1/2	13/16 - 16 UN	£15.88
8G10FFORX90S	1/2	1 - 14 UNS	£18.01
8G12FFORX90S	1/2	1 3/16 - 12 UN	£45.50
10G10FFORX90S	5/8	1 - 14 UNS	£30.29
10G12FFORX90S	5/8	1 3/16 - 12 UN	£34.92
12G10FFORX90S	3/4	1 - 14 UNS	£80.48
12G12FFORX90S	3/4	1 3/16 - 12 UN	£26.12
12G16FFORX90S	3/4	1 7/16 - 12 UN	£60.78
16G12FFORX90S	1	1 3/16 - 12 UN	£102.65
16G16FFORX90S	1	1 7/16 - 12 UN	£41.11

ORFS Flange Coupling

O-Ring Seal
Code 61



PGC: 375	ID (")	Flange Size	Price
8G8FL	1/2	1/2	£19.08
8G12FL	1/2	3/4	£44.23
10G12FL	5/8	3/4	£48.80
12G12FL	3/4	3/4	£21.57
12G16FL	3/4	1	£30.29
16G12FL	1	3/4	£30.36
16G16FL	1	1	£28.65
16G20FL	1	1 1/4	£49.33
16G24FL	1	1 1/2	£52.46

ORFS Flange Coupling

45° Swept Elbow
O-Ring Seal
Code 61 (3000 Series)
Medium Drop to ISO 1251-3



PGC: 375	ID (")	Flange Size	Price
8G12FL45M	1/2	3/4	£46.37
12G12FL45M	3/4	3/4	£28.84
12G16FL45S	3/4	1	£34.97
16G12FL45	1	3/4	£44.86
16G16FL45S	1	1	£42.24
16G20FL45S	1	1 1/4	£47.97
20G20FL45S	1 1/4	1 1/4	£76.23

ORFS Flange Coupling

90° Swept Elbow
O-Ring Seal
Code 61 (6000 Series)
Short & Medium Drop to ISO 12151-3



PGC: 375	ID (")	Flange Size	Price
8G8FL90M	1/2	1/2	£19.61
8G12FL90M	1/2	3/4	£37.64
12G12FL90M	3/4	3/4	£22.38
12G16FL90S	3/4	1	£30.58
16G16FL90S	1	1	£32.60
16G20FL90S	1	1 1/4	£44.32



A Tomkins Company

Flange Kits & PowerWash Couplings

Flange Kits

SAE High Pressure Dual Flange Kit

Code 62 (metric) (6000 Series)

- Each kit Comprises:
- dual flange
 - 4 bolts
 - 4 washers
 - O-ring



PGC: 376	ID (")	Price
8FLHCFM	1/2	£12.11
12FLHCFM	3/4	£14.19
16FLHCFM	1	£16.64
20FLHCFM	1 1/4	£24.06
24FLHCFM	1 1/2	£47.55
32FLHCFM	2	£71.79

SAE High Pressure Flange Kit

Code 62 (6000 Series)



- Each kit Comprises:
- 2 flange halves (PLFLH-75)
 - 4 bolts
 - 4 washers
 - O-ring (PA-FL77)

PGC: 376	ID (")	Price
08PA-FLH	1/2	£11.60
12PA-FLH	3/4	£11.81
16PA-FLH	1	£16.00
20PA-FLH	1 1/4	£20.22
24PA-FLH	1 1/2	£42.69
32PA-FLH	2	£69.26

SAE Standard Pressure Flange Kit

Code 61 (3000 Series)



- Each kit Comprises:
- 2 flange halves (PA-FL75)
 - 4 bolts
 - 4 washers
 - O-ring (PA-FL77)

PGC: 376	ID (")	Price
08PA-FL	1/2	£9.46
12PA-FL	3/4	£9.40
16PA-FL	1	£11.62
20PA-FL	1 1/4	£13.19
24PA-FL	1 1/2	£17.00
32PA-FL	2	£38.18

PowerWash Couplings

PowerWash PWSP

Male PowerWash Standpipe with O-ring



- Connection: Standpipe with O-ring
- Sealing: O-ring against metal
- Material: Steel

PGC: 375	ID (")	Price
4G10PWSP	1/4	£29.84
5G10PWSP	5/16	£7.78
5G11PWSP	5/16	£7.78
6G10PWSP	3/8	£18.25
6G11PWSP	3/8	£18.25

PowerWash FPWX Union Nut

Female PowerWash Swivel



- Connection: Swivel female
- Sealing: Metal against metal
- Material: Steel

PGC: 375	ID (")	Thread	Price
4G15FPWX	1/4	M22 x 1.5	£10.23
5G15FPWX	5/16	M22 x 1.5	£9.63
6G15FPWX	3/8	M22 x 1.5	£9.79



HOSE ASSEMBLIES

Made-to-Measure Gates' Hydraulic Hose Assemblies

We can make up **any** hose assembly using Gates' hydraulic hoses and fittings.†

To place your order, please contact our Sales Team specifying:

Hose Type

Select a Gates' hose choosing appropriate size, materials and pressure rating to suit your application.

Hose Assembly Length

Measure from cone face to cone face, or cone face to centre line if elbow fittings are being used.

End Fittings

Select Gates' GlobalSpiral™ or MegaCrimp® hose fittings according to the angle and thread required for your assembly.

Offset Angle Measurement

The number of degrees between two hose fittings measured in a clockwise direction.*



A Tomkins Company

* Tolerances on the offset angle are +/- 3° for assemblies up to 0.6 m long and +/- 5° for assemblies 0.6 m and longer.

† The ranges of Gates' hoses and couplings in this catalogue represents only a selection of those from which we can make assemblies.



GlobalSpiral™ Hydraulic Hose Couplings

A Tomkins Company

02

The GlobalSpiral™ (GS) hydraulic coupling from Gates does not require hose skiving, thereby reducing assembly time, labour, fabrication errors, and contamination of the fluid power system.

GlobalSpiral™ flanges are solid, reliable one-piece couplings with no braze/weld joints, tapered heads and thick tube walls to increase stress and vibration resistance and eliminate possible leak points.

Gates' GlobalSpiral™ coupling can be used worldwide for all Gates high-pressure spiral wire hoses with ratings from 3,000 to 6,000 psi.

Features	Benefits
One coupling for all high-pressure spiral wire hoses from 3,000 to 6,000 psi.	Simplifies inventory management. Reduces assembly errors.
No-skive assembly (internal or external).	Reduces labour, assembly time and errors, odour, and contamination from rubber dust.
Two-piece design.	Assembler can verify that stem is fully inserted into hose. Proper assembly reduces leaks.
Lead-free steel.	Environmentally friendly with maximum strength.
Available in +30 thread / flange configurations.	Increased application coverage.
"Bite the wire" crimp.	Improved coupling retention and blow-off prevention.
+121°C temperature capability. Tested to 1,000,000 impulse cycles.	Full performance at high temperatures. Extended Coupling Life.

TuffCoat™ Hydraulic Coupling Coating



All Gates global couplings come with TuffCoat™ hydraulic coupling plating as a standard feature. Tested under ISO 9227 and ASTM B117 salt-spray conditions, Gates' revolutionary TuffCoat™ coating provided 400 hours of protection against corrosion a 400-plus percent improvement over the 96-hour ISO standard.

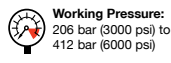
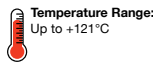

BSPP Couplings

Male BSPP Coupling

60° Inverted Cone



PGC: 376	ID (")	BSPP	Price
6GS6MBSPP	3/8	3/8	£6.30
6GS8MBSPP	3/8	1/2	£15.28
8GS8MBSPP	1/2	1/2	£8.04
10GS10MBSPP	5/8	5/8	£16.65
10GS12MBSPP	5/8	3/4	£27.49
12GS12MBSPP	3/4	3/4	£11.94
16GS16MBSPP	1	1	£16.90

Female BSPP Coupling

Female BSPP O-Ring Seal
60° Cone



PGC: 376	ID (")	BSPP	Price
6GS6FBSPPORX	3/8	3/8	£5.49
6GS8FBSPPORX	3/8	1/2	£11.78
8GS8FBSPPORX	1/2	1/2	£7.26
8GS10FBSPPORX	1/2	5/8	£17.14
10GS10FBSPPORX	5/8	5/8	£7.56
10GS12FBSPPORX	5/8	3/4	£15.89
12GS12FBSPPORX	3/4	3/4	£11.01
12GS16FBSPPORX	3/4	1	£40.21
16GS16FBSPPORX	1	1	£17.41

Female BSPP Coupling 90° Swept Elbow

O-Ring Seal
60° Cone



PGC: 376	ID (")	BSPP	Price
6GS6FBSPPORX90	3/8	3/8	£9.79
8GS8FBSPPORX90	1/2	1/2	£14.43
10GS10FBSPPORX90	5/8	5/8	£38.61
10GS12FBSPPORX90	5/8	3/4	£40.54
12GS12FBSPPORX90	3/4	3/4	£18.71
16GS16FBSPPORX90	1	1	£30.55

Ferrules

No Skive Ferrules



PGC: 376	ID (")	Price
6GS1F-4	3/8	£2.93
8GS1F-4	1/2	£2.99
10GS1F-4	5/8	£6.29
12GS1F-4	3/4	£7.29
16GS1F-4	1	£9.57

JIC Couplings

Female JIC Swivel

37° Inverted Cone



PGC: 376	ID (")	Thread	Price
6GS6FJX	3/8	9/16 - 18 UNF	£6.51
6GS8FJX	3/8	3/4 - 16 UNF	£8.28
8GS8FJX	1/2	3/4 - 16 UNF	£8.35
8GS10FJX	1/2	7/8 - 14 UNF	£10.75
8GS12FJX	1/2	1 1/16 - 12 UNF	£17.85
10GS10FJX	5/8	7/8 - 14 UNF	£9.03
10GS12FJX	5/8	1 1/16 - 12 UNF	£12.20
12GS10FJX	3/4	7/8 - 14 UNF	£55.58
12GS12FJX	3/4	1 1/16 - 12 UNF	£12.05
12GS14FJX	3/4	1 3/16 - 12 UNF	£31.84
12GS16FJX	3/4	1 5/16 - 12 UNF	£29.60
16GS12FJX	1	1 1/16 - 12 UNF	£92.08
16GS14FJX	1	1 3/16 - 12 UNF	£163.30
16GS16FJX	1	1 5/16 - 12 UNF	£18.92
16GS20FJX	1	1 5/8 - 12 UNF	£66.25

Female JIC Swivel 45° Swept Elbow 37° Inverted Cone



PGC: 376	ID (")	Thread	Price
6GS6FJX45S	3/8	9/16 - 18 UNF	£12.45
6GS8FJX45S	3/8	3/4 - 16 UNF	£18.71
8GS8FJX45S	1/2	3/4 - 16 UNF	£14.62
8GS10FJX45S	1/2	7/8 - 14 UNF	£28.80
10GS10FJX45S	5/8	7/8 - 14 UNF	£27.51
10GS12FJX45S	5/8	1 1/16 - 12 UN	£61.60
12GS12FJX45S	3/4	1 1/16 - 12 UN	£25.79
12GS16FJX45S	3/4	1 5/16 - 12 UN	£52.07
16GS16FJX45S	1	1 5/16 - 12 UN	£35.93
16GS20FJX45S	1	1 5/8 - 12 UN	£110.77

Male JIC Coupling 37° Cone



PGC: 376	ID (")	Thread (UNF)	Price
6GS6MJ	3/8	9/16 - 18	£7.39
6GS8MJ	3/8	3/4 - 16	£13.74
6GS10MJ	3/8	7/8 - 14	£27.08
8GS8MJ	1/2	3/4 - 16	£7.98
8GS10MJ	1/2	7/8 - 14	£9.20
10GS10MJ	5/8	7/8 - 14	£16.85
10GS12MJ	5/8	1 1/16 - 12	£20.90
12GS12MJ	3/4	1 1/16 - 12	£16.98
12GS14MJ	3/4	1 3/16 - 12	£37.37
12GS16MJ	3/4	1 5/16 - 12	£23.28
16GS16MJ	1	1 5/16 - 12	£24.01
16GS20MJ	1	1 5/8 - 12	£45.89

Female ORFS Coupling 45° Swept Elbow Flat Face O-Ring Seal Short Drop to ISO 12151-1



PGC: 376	ID (")	Thread (UNS)	Price
6GS6FFORX45S	3/8	1 1/16 - 16	£15.49
6GS8FFORX45S	3/8	1 3/16 - 16	£52.03
8GS8FFORX45S	1/2	1 3/16 - 16	£16.28
8GS10FFORX45S	1/2	1 - 14	£168.88
10GS10FFORX45S	5/8	1 - 14	£62.08
12GS12FFORX45S	3/4	1 3/16 - 12	£25.60
12GS16FFORX45S	3/4	1 7/16 - 12	£109.58
16GS16FFORX45S	1	1 7/16 - 12	£43.01
16GS20FFORX45S	1	1 11/16 - 12	£169.30

Female JIC Swivel 90° Swept Elbow 37° Inverted Cone Short Drop to ISO 12151-5



PGC: 376	ID (")	Thread	Price
6GS6FJX90S	3/8	9/16 - 18 UNF	£9.88
8GS8FJX90S	1/2	3/4 - 16 UNF	£14.62
8GS10FJX90S	1/2	7/8 - 14 UNF	£28.80
8GS12FJX90S	1/2	1 1/16 - 12 UN	£140.33
10GS10FJX90S	5/8	7/8 - 14 UNF	£65.01
12GS12FJX90S	3/4	1 1/16 - 12 UN	£25.79
12GS16FJX90S	3/4	1 5/16 - 12 UN	£84.76
16GS16FJX90S	1	1 5/16 - 12 UN	£36.26

ORFS Couplings

Female ORFS Coupling Flat Face O-Ring Seal



PGC: 376	ID (")	Thread (UNS)	Price
6GS8FFORX	3/8	1 1/16 - 16	£10.17
6GS8FFORX	3/8	1 3/16 - 16	£11.25
8GS8FFORX	1/2	1 3/16 - 16	£10.52
8GS10FFORX	1/2	1 - 14	£24.28
8GS12FFORX	1/2	1 3/16 - 12	£85.63
10GS10FFORX	5/8	1 - 14	£13.20
10GS12FFORX	5/8	1 3/16 - 12	£57.45
12GS10FFORX	3/4	1 - 14	£51.92
12GS12FFORX	3/4	1 3/16 - 12	£19.91
12GS16FFORX	3/4	1 7/16 - 12	£62.07
12GS20FFORX	3/4	1 11/16 - 12	£78.07
16GS16FFORX	1	1 7/16 - 12	£24.03
16GS20FFORX	1	1 11/16 - 12	£133.13

Female ORFS Coupling 90° Swept Elbow Flat Face O-Ring Seal Short Drop to ISO 12151-1



PGC: 376	ID (")	Thread (UNS)	Price
6GS6FFORX90S	3/8	1 1/16 - 16	£14.92
8GS8FFORX90S	1/2	1 3/16 - 16	£15.22
8GS12FFORX90S	1/2	1 3/16 - 12	£99.76
10GS10FFORX90S	5/8	1 - 14	£62.08
12GS10FFORX90S	3/4	1 - 14	£111.05
12GS12FFORX90S	3/4	1 3/16 - 12	£102.10
12GS16FFORX90S	3/4	1 7/16 - 12	£132.04
16GS16FFORX90S	1	1 7/16 - 12	£128.73
16GS20FFORX90S	1	1 11/16 - 12	£162.33

Medium Drop to ISO 12151-5

PGC: 376	ID (")	Thread	Price
6GS8FJX90M	3/8	3/4 - 16 UNF	£19.57
8GS8FJX90M	1/2	3/4 - 16 UNF	£18.72
8GS10FJX90M	1/2	7/8 - 14 UNF	£16.43
10GS10FJX90M	5/8	7/8 - 14 UNF	£28.74
10GS12FJX90M	5/8	1 1/16 - 12 UN	£38.65
12GS12FJX90M	3/4	1 1/16 - 12 UN	£20.85
12GS16FJX90M	3/4	1 5/16 - 12 UN	£64.59
16GS16FJX90M	1	1 5/16 - 12 UN	£45.59

Male ORFS Coupling Flat Face O-Ring Seal



PGC: 376	ID (")	Thread (UNS)	Price
6GS6MFFOR	3/8	1 1/16 - 16	£67.55
8GS8MFFOR	1/2	1 3/16 - 16	£18.20
12GS12MFFOR	3/4	1 3/16 - 12	£40.40
12GS16MFFOR	3/4	1 7/16 - 12	£95.00
16GS16MFFOR	1	1 11/16 - 12	£87.46

Medium Drop to ISO 12151-1

PGC: 376	ID (")	Thread (UNS)	Price
6GS8FFORX90M	3/8	1 3/16 - 16	£53.63
8GS10FFORX90M	1/2	1 3/16 - 12	£30.00
10GS10FFORX90M	5/8	1 - 14	£30.52
12GS12FFORX90M	3/4	1 3/16 - 12	£26.17
16GS16FFORX90M	1	1 7/16 - 12	£46.00
16GS20FFORX90M	1	1 11/16 - 12	£112.20

Long Drop to ISO 12151-5

PGC: 376	ID (")	Thread	Price
6GS6FJX90L	3/8	9/16 - 18 UNF	£56.92
8GS8FJX90L	1/2	3/4 - 16 UNF	£110.91
8GS10FJX90L	1/2	7/8 - 14 UNF	£74.11
12GS12FJX90L	3/4	1 1/16 - 12 UN	£74.89
16GS16FJX90L	1	1 5/16 - 12 UN	£97.35
16GS20FJX90L	1	1 5/8 - 12 UN	£195.97

SAE Couplings

SAE Flange Coupling

SAE O-Ring Flange
3000 Series
(Code 61)



PGC: 376	ID (")	Flange Size (")	Price
6GS8FL	3/8	1/2	£80.87
8GS8FL	1/2	1/2	£15.89
8GS12FL	1/2	3/4	£48.55
10GS12FL	5/8	3/4	£37.15
12GS8FL	3/4	1/2	£57.76
12GS12FL	3/4	3/4	£19.87
12GS16FL	3/4	1	£30.52
12GS20FL	3/4	1 1/4	£59.10
16GS16FL	1	1	£28.26
16GS20FL	1	1 1/4	£48.36
16GS24FL	1	1 1/2	£75.36

6000 Series

PGC: 376	ID (")	Flange Size (")	Price
8GS8FLH	1/2	1/2	£36.60
8GS12FLH	1/2	3/4	£65.83
10GS8FLH	5/8	1/2	£39.91
10GS12FLH	5/8	3/4	£35.45
12GS12FLH	3/4	3/4	£33.13
12GS16FLH	3/4	1	£41.19
16GS12FLH	1	3/4	£45.28
16GS16FLH	1	1	£41.19
16GS20FLH	1	1 1/4	£53.65

SAE Flange Coupling 45° Swept Elbow

SAE O-Ring Flange
3000 Series (Code 61)
Short & Medium Drop to ISO 12151-3



PGC: 376	ID (")	Flange Size (")	Price
6GS8FL45M	3/8	1/2	£123.01
8GS8FL45M	1/2	1/2	£20.99
8GS12FL45M	1/2	3/4	£38.95
10GS12FL45M	5/8	3/4	£54.76
12GS12FL45M	3/4	3/4	£25.77
12GS16FL45S	3/4	1	£35.36
16GS16FL45M	1	1	£33.10
16GS20FL45M	1	1 1/4	£67.54
20GS16FL45M	1 1/4	1	£87.07
20GS20FL45S	1 1/4	1 1/4	£73.25
20GS24FL45S	1 1/4	1 1/2	£92.52
24GS24FL45	1 1/2	1 1/2	£91.86
24GS32FL45	1 1/2	2	£110.25

SAE Flange Coupling 90° Swept Elbow

SAE O-Ring Flange
3000 Series (Code 61)
Short & Medium Drop to ISO 12151-3



PGC: 376	ID (")	Flange Size (")	Price
6GS8FL90M	3/8	1/2	£131.86
8GS8FL90M	1/2	1/2	£19.92
8GS12FL90M	1/2	3/4	£39.69
10GS12FL90M	5/8	3/4	£54.76
12GS12FL90M	3/4	3/4	£28.15
12GS16FL90M	3/4	1	£50.45
16GS16FL90M	1	1	£33.10
16GS20FL90M	1	1 1/4	£67.54

SAE Flange Coupling 90° Swept Elbow

SAE O-Ring Flange
6000 Series (Code 62)
Medium Drop to ISO 12151-3



PGC: 376	ID (")	Flange Size (")	Price
8GS8FLH90M	1/2	1/2	£36.60
8GS12FLH90M	1/2	3/4	£90.87
10GS8FLH90M	5/8	1/2	£52.28
10GS12FLH90M	5/8	3/4	£51.00
12GS12FLH90M	3/4	3/4	£35.84
12GS16FLH90M	3/4	1	£45.28
16GS12FLH90M	1	3/4	£55.92
16GS16FLH90M	1	1	£47.43
16GS20FLH90M	1	1 1/4	£58.46

DIN Couplings

Female DIN Coupling

Female DIN O-Ring
24° Cone
Light Series



PGC: 376	ID (")	Thread	Price
6GS12FDLORX	3/8	M18x1.5	£9.60
8GS15FDLORX	1/2	M22x1.5	£11.41
10GS18FDLORX	5/8	M26x1.5	£15.63
12GS22FDLORX	3/4	M30x2	£20.13
12GS28FDLORX	3/4	M36x2	£44.46
16GS28FDLORX	1	M36x2	£41.02

Heavy Series

PGC: 376	ID (")	Thread	Price
6GS12FDHORX	3/8	M20x1.5	£10.07
6GS14FDHORX	3/8	M22x1.5	£13.86
8GS14FDHORX	1/2	M22x1.5	£88.44
8GS16FDHORX	1/2	M24x1.5	£12.84
8GS20FDHORX	1/2	M30x2	£25.03
10GS20FDHORX	5/8	M30x2	£16.37
10GS25FDHORX	5/8	M36x2	£59.53
12GS20FDHORX	3/4	M30x2	£22.79
12GS25FDHORX	3/4	M36x2	£30.09
16GS25FDHORX	1	M36x2	£35.93
16GS30FDHORX	1	M42x2	£40.89

Male DIN Coupling

Male DIN
24° Inverted Cone
Light Series



PGC: 376	ID (")	Thread	Price
6GS12MDL	3/8	M18x1.5	£10.74
8GS15MDL	1/2	M22x1.5	£10.86
10GS18MDL	5/8	M26x1.5	£18.29
12GS22MDL	3/4	M30x2	£38.02
16GS28MDL	1	M36x2	£42.55

Heavy Series

PGC: 376	ID (")	Thread	Price
6GS12MDH	3/8	M20x1.5	£10.73
6GS14MDH	3/8	M22x1.5	£13.90
8GS16MDH	1/2	M24x1.5	£12.57
10GS20MDH	5/8	M30x2	£19.93
12GS20MDH	3/4	M30x2	£28.19
12GS25MDH	3/4	M36x2	£24.58
12GS30MDH	3/4	M36x2	£38.02
16GS25MDH	1	M30x2	£48.61
16GS30MDH	1	M36x2	£38.88

Female DIN Coupling 90° Swept Elbow

Female DIN O-Ring
24° Cone
Light Series



PGC: 376	ID (")	Thread	Price
6GS12FDLORX90	3/8	M18x1.5	£18.43
8GS15FDLORX90	1/2	M22x1.5	£23.44
12GS22FDLORX90	3/4	M30x2	£19.24

Heavy Series

PGC: 376	ID (")	Thread	Price
6GS12FDHORX90	3/8	M20x1.5	£16.76
6GS14FDHORX90	3/8	M22x1.5	£29.48
10GS20FDHORX90	5/8	M30x2	£26.98
12GS20FDHORX90	3/4	M30x2	£28.17
12GS25FDHORX90	3/4	M36x2	£46.81
16GS25FDHORX90	1	M36x2	£41.89
16GS30FDHORX90	1	M42x2	£70.45



Never underestimate the power of a blown hydraulic assembly. It can cause serious injury or worse to anyone who gets in the way. If you're using a "mix and match" approach with your hose and connectors, you're taking unnecessary risks. Risks that Gates Fluid Power can help you manage.



Gates designs, manufactures and tests all of its products to meet the highest performance and safety standards. Can you afford anything less for your applications and your people?

The Gates Hydraulic Safety and Preventive Maintenance Program

helps you cut costs and prevent injuries from hydraulic assembly failures.





It's FREE information for maintenance managers, repair technicians and machine operators - and anyone else working with high-power fluid pressure systems.



For details about available Training Courses visit:

www.safehydraulicseurope.com

Did You Know ...

-  that mixing and matching of components of different sources that are not validated nor tested is impermissible (98/37/CE - EN 982)?
-  that the repair of hose assemblies is forbidden by law (98/37/CE - EN 982)?
-  that marking, indicating day and year of manufacture is obligatory (EN 982)?
-  that the lifetime of hose assemblies is indeed limited?
-  that fluids under pressure can cause injuries which can result in the loss of the injured body part or even death?
-  that the assembler can be held responsible for the consequences of a failed hydraulic hose assembly (98/37/CE - EN 982)?

New EnviroFluid™ hydraulic spiral hose from Gates.

Environmentally friendly oils are anything but friendly to hydraulic high-pressure hoses. They seep right through the tube, through the different layers of reinforcement, eventually blistering or permeating the cover. Traces of oil appear on the surface and an unsightly, possibly unsafe problem remains. Premature replacement used to be the only solution

Now you can say goodbye to cover blisters and greasy hoses with the introduction of Gates' new EnviroFluid™ spiral hose. The secret is the special nitrile-tube compound similar to the modified-nitrile used in Gates' popular wire braid hoses. EnviroFluid™ stands for a unique spiral hose construction offering you even more unbeatable advantages.





A Tomkins Company

Hydraulic Hose

Hydraulic Products for the Growing World of Industry

Gates hydraulic hoses are used worldwide in an almost endless range of applications, from construction, mining and manufacturing to agriculture and transport, to name but some. Gates products are designed to meet the needs of global customers. The Gates Global Hydraulic Hose line was specifically developed to meet all major global quality standards.

Gates manufacture couplings that meet EN/DIN and SAE standards. So whether your equipment was made in Japan, Europe, the United States or elsewhere, Gates has products to fit your application needs. All Gates products meet exacting quality standards.

Hydraulic Products Designed for Global Applications

Gates Global Hoses and Couplings meet strict international specification guidelines and even more stringent Gates quality specifications before they can carry a Gates logo. Wherever your equipment is made, Gates has hose, couplings, adaptors and other hydraulic equipment to fit your needs, including:

- Spiral hose and couplings
- Wire braid hose and couplings
- Textile braid, high temperature hose and couplings
- Return line / low pressure hose and couplings
- Thermoplastic hose and couplings
- Other speciality hose and couplings

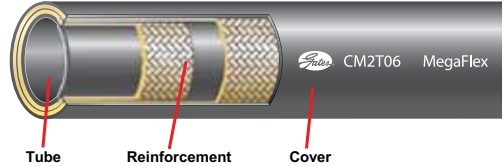

EnviroFluid™ Spiral Wire Hose

Gates EnviroFluid™ Spiral Wire Hose is specially designed to handle biodegradable hydraulic fluids and other aggressive oils like synthetic esters, polyglycols and vegetable oils at extremely high pressure and high impulse. The nitrile tube is tough enough to handle biodegradable fluids at operating temperatures up to +121°C without any loss of performance. Additionally, it offers significantly lower permeation than Neoprene® tubes when used with petroleum-based oils.

MegaTuff® Hose Covers

Certain Gates High Pressure Hoses are also available optionally with MegaTuff® hose covers. MegaTuff® covers possess superior ozone and weathering resistance and lasted up to 300 times longer than standard covers in hose-to-hose and hose-to-metal abrasion tests as per ISO 6945. Typical applications include mining, injection moulding, quarrying and construction.



XtraTuff™ Hose Covers

XtraTuff™ is a more economical version of Gates' robust and abrasion-resistant MegaTuff® cover. Made of special hybrid compounds, the new cover material increases service life, lowers maintenance, and eliminates the need for costly hose protectors such as guards, sleeves and bundling. XtraTuff™ is 25 times more abrasion resistant than than standard rubber hose coverings.



Constant Pressure

EFG6K EnviroFluid™ Spiral Wire Hose

4-Wire Hydraulic Hose

Tube: Nitrile (NBR)

Reinforcement: Spiralled High Tensile Steel

Cover: Neoprene®



Temperature Range:
-40°C to +121°C



Working Pressure:
6000 psi



- For Biodegradable Hydraulic Fluids and Aggressive Oils
- Recommended for extremely high pressure and high impulse applications such as hydraulic transmissions
- Standards: SAE100R15, EN856 4SP, EN856 4SH
- For use with no-skive GlobalSpiral™ Couplings
- MSHA Approved (Flame Resistant to US.MSHA 2G)

PGC: 370	ID (")	OD (mm)	Working Pressure (psi)	Burst Pressure (psi)	Price
6EFG6K	3/8	20.5	6000	24000	£40.98
8EFG6K	1/2	24	6000	24000	£44.49
10EFG6K	5/8	27.6	6000	24000	£50.85
12EFG6K	3/4	31.4	6000	24000	£57.17
16EFG6K	1	38.7	6000	24000	£75.23



EFG6K-MTF: the complete range of EFG6K Hose is also available with Gates' unique abrasion-resistant MegaTuff® cover. Please ask our Sales Team for more information.

EFG5K EnviroFluid™ Spiral Wire Hose

4-Wire Hydraulic Hose

Tube: Nitrile (NBR)

Reinforcement: Spiralled High Tensile Steel

Cover: Neoprene®



Temperature Range:
-40°C to +121°C



Working Pressure:
5000 psi



- For Biodegradable Hydraulic Fluids and Aggressive Oils
- Recommended for extremely high pressure and high impulse applications
- Standards: EN856 R13, SAE 100R13, EN856 4SP
- For use with no-skive GlobalSpiral™ Couplings
- MSHA Approved (Flame Resistant to US.MSHA 2G)

PGC: 370	ID (")	OD (mm)	Working Pressure (psi)	Burst Pressure (psi)	Price
6EFG5K	3/8	20.5	5000	20000	£38.78
8EFG5K	1/2	24	5000	20000	£42.11
10EFG5K	5/8	27.6	5000	20000	£45.70
12EFG5K	3/4	31.4	5000	20000	£50.65
16EFG5K	1	38.7	5000	20000	£68.70



EFG5K-MTF: the complete range of EFG5K Hose is also available with Gates' unique abrasion-resistant MegaTuff® cover. Please ask our Sales Team for more information.

ISO/EN/SAE/ Standard

CM2T Megaflex® Braided Hose

2-Wire Hydraulic Hose
Tube: Nitrile (NBR) Tube
Reinforcement: High Tensile Steel Wire
Cover: Modified Nitrile (NBR)

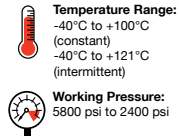

Temperature Range:
 -40°C to +100°C (constant)
 -40°C to +121°C (intermittent)

Working Pressure:
 5800 psi to 2400 psi

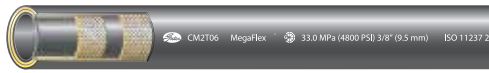

CM2T06 Megaflex 33.0 MPa (4800 PSI) 3/8" (9.5 mm) ISO 11237 2S

- Recommended for high pressure hydraulic applications
- Standards: EN 857 2SC, ISO 1436
- For use with no-skive MegaCrimp® Couplings

PGC: 371	ID (")	OD (mm)	Working Pressure (psi)	Burst Pressure (psi)	Price
CM2T04	1/4	14.1	5800	23200	£18.46
CM2T05	5/16	15.5	5000	20000	£20.02
CM2T06	3/8	17.7	4800	19200	£21.10
CM2T08	1/2	20.8	4000	16000	£24.31
CM2T10	5/8	24.6	3625	14500	£28.66
CM2T12	3/4	27.8	3100	12400	£33.38
CM2T16	1	35.8	2400	9600	£50.52

G1 Braided Hose

1-Wire Hydraulic Hose
Tube: Nitrile (NBR) Tube
Reinforcement: High Tensile Steel Wire
Cover: Modified Nitrile (NBR)

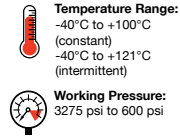

Temperature Range:
 -40°C to +100°C (constant)
 -40°C to +121°C (intermittent)

Working Pressure:
 3275 psi to 600 psi

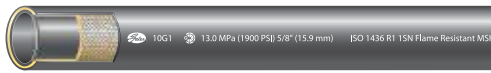

10G1 13.0 MPa (1900 PSI) 5/8" (15.9 mm) ISO 1436 R1 1SN Flame Resistant MSH

- Recommended for high pressure hydraulic applications
- Standards: EN 853 1SN, ISO 1436
- For use with no-skive MegaCrimp® and GlobalSpiral™ Plus Couplings

PGC: 371	ID (")	OD (mm)	Working Pressure (psi)	Burst Pressure (psi)	Price
4G1	1/4	13.5	3275	13100	£16.01
5G1	5/16	15.1	3125	12500	£17.98
6G1	3/8	17.1	2800	10400	£19.29
8G1	1/2	20.3	2325	9300	£21.72
10G1	5/8	23.5	1900	7600	£25.37
12G1	3/4	27.6	1525	6100	£31.87
16G1	1	35.4	1275	5100	£44.33
20G1	1 1/4	43.4	925	3700	£55.32
24G1	1 1/2	49.8	725	2900	£64.49
32G1	2	64.0	600	2400	£87.61

G2 Braided Hose

2-Wire Hydraulic Hose
Tube: Nitrile (NBR) Tube
Reinforcement: High Tensile Steel Wire
Cover: Modified Nitrile (NBR)

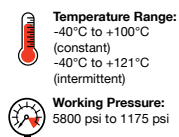

Temperature Range:
 -40°C to +100°C (constant)
 -40°C to +121°C (intermittent)

Working Pressure:
 5800 psi to 1175 psi

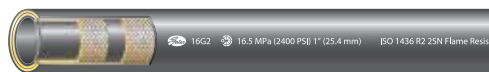

16G2 16.5 MPa (2400 PSI) 1" (25.4 mm) ISO 1436 R2 2SN Flame Resistant

- Recommended for high pressure hydraulic applications
- Standards: EN 853 2SN, ISO 1436
- For use with no-skive MegaCrimp® and GlobalSpiral™ Plus Couplings

PGC: 371	ID (")	OD (mm)	Working Pressure (psi)	Burst Pressure (psi)	Price
4G2	1/4	0.58	5800	23200	£17.58
5G2	5/16	0.64	5100	20300	£19.04
6G2	3/8	0.73	4800	19200	£20.50
8G2	1/2	0.86	4000	16000	£23.77
10G2	5/8	0.98	3625	14500	£28.31
12G2	3/4	1.14	3100	12400	£34.80
16G2	1	1.48	2400	9600	£46.98
20G2	1 1/4	1.87	1825	7300	£73.18
24G2	1 1/2	2.15	1300	5200	£91.32
32G2	2	2.65	1175	4700	£113.57

TH8 Thermoplastic Hydraulic Hose

"Crimpable" Thermoplastic Hose
Tube: 100% Seamless Nylon Type Z
Reinforcement: Braided synthetic fibre (-2 size is spiralled)
Cover: Polyurethane

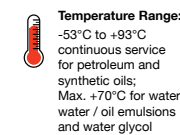

Temperature Range:
 -53°C to +93°C continuous service for petroleum and synthetic oils;
 Max. +70°C for water, water / oil emulsions and water glycol

Working Pressure:
 5000 psi to 2000 psi



12TH8 15.5 MPa (2250 PSI) 1 1/2" (38.1 mm) ISO 1436 R2 2SN Flame Resistant

- Perforated for use in general hydraulic and pneumatic applications
- Standards: ISO 3949 & SAE 100R8
- For use with no-skive MegaCrimp® Couplings

PGC: 371	ID (")	OD (mm)	Working Pressure (psi)	Burst Pressure (psi)	Price
4GT8	1/4	15.5	5000	20000	£22.04
6GT8	3/8	19.1	4000	16000	£26.09
8GT8	1/2	22.1	3500	14000	£36.32
12GT8	3/4	28.7	2250	9000	£50.13
16GT8	1	36.8	2000	8000	£76.68



A Tomkins Company

Industrial Hose

02

Gates manufactures a broad selection of hard wearing, industrial hose products for fluids, powders and gases that are being conveyed in almost any material handling operation.

If you can't find the hose you need in the catalogue, please contact our helpful Sales Team.

Multi-Purpose Hose

GP40 Hose

Industrial Hose

Tube: EPDM based

Reinforcement: One or two textile layers

Cover: EPDM based



Temperature Range:

-40°C to +100°C (constant)
-40°C to +121°C (intermittent)



Working Pressure:
190 psi



- Recommended for general service up to +80°C, general water service up to +100°C and applications requiring maximum flexibility and high abrasion resistance.
- Resistant to ozone and weather influences
- For use with no-skive MegaCrimp® Couplings; -24: ES-A

PGC: 373	ID (")	OD (mm)	Working Pressure (psi)	Burst Pressure (psi)	Price
GP40-06	1/4	12	190	580	£4.97
GP40-08	5/16	15	190	580	£5.28
GP40-10	3/8	17	190	580	£6.10
GP40-13	1/2	20.5	190	580	£7.24
GP40-16	5/8	24	190	580	£9.74
GP40-19	3/4	28	190	580	£12.26
GP40-25	1	35	190	580	£17.58
GP40-32	1 1/4	44	190	580	£29.44
GP40-38	1 1/2	51	190	580	£34.98

GP80 Plus Hose

Industrial Hose

Tube: Nitrile (NBR) based

Reinforcement: One or two fibre braids

Cover: NBR/PVC based



Temperature Range:

-40°C to +100°C (constant)
-40°C to +121°C (intermittent)



Working Pressure:
440 psi to 540 psi



- Recommended for general industrial applications such as oil, alcohols, aqueous solutions, hydraulic fluids, acids, detergents and chemicals
- Static conductive for more security
- For use with no-skive MegaCrimp® Couplings; -24, -32: ES-A

PGC: 373	ID (")	OD (mm)	Working Pressure (psi)	Burst Pressure (psi)	Price
GP80-06	1/4	13	540	760	£7.87
GP80-08	5/16	15	540	760	£8.62
GP80-10	3/8	17	540	760	£9.74
GP80-13	1/2	20.5	540	835	£11.35
GP80-16	5/8	24.2	440	500	£15.55
GP80-19	3/4	29	440	500	£20.03
GP80-25	1	35.6	440	500	£26.94
GP80-32	1 1/4	42.8	440	250	£47.80
GP80-38	1 1/2	51	440	250	£66.82
GP80-50	2	64	440	125	£95.37

Fuel and Oil Hose

GP60 Hose

Industrial Hose

Tube: Nitrile (NBR)

Reinforcement: One fibre braid

Cover: NBR/PVC based



Temperature Range:

-40°C to +100°C



Working Pressure:
2902 psi

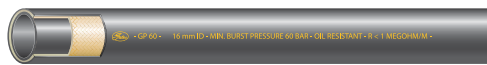

- Recommended for hot water wash down applications up to +100°C, general industrial applications such as oil and hydraulic fluids (+100°C), alcohols and aqueous solutions
- For use with no-skive MegaCrimp® Couplings

PGC: 373	ID (")	OD (mm)	Working Pressure (psi)	Burst Pressure (psi)	Price
GP60-06	1/4	13	2902	8706	£6.52
GP60-08	5/16	15	2902	8706	£6.88
GP60-10	3/8	17	2902	8706	£7.97
GP60-13	1/2	20.5	2902	8706	£9.73
GP60-16	5/8	24.2	2902	8706	£12.69
GP60-19	3/4	29	2902	8706	£16.36
GP60-25	1	35.6	2902	8706	£21.99

Premium™ GP Master

Industrial Hose

Tube: Nitrile (NBR) based

Reinforcement: Fibre braids

Cover: CR (Chloroprene) based



Temperature Range:

-40°C to +95°C



Working Pressure:
360 psi

60 m COIL



- Recommended for general industrial applications such as compression air, oil, aqueous solutions, petrol, fuel oil and lubricant oils
- For premium grade spiralled hose with excellent flexibility

PGC: 650	ID (mm)	OD (mm)	Working Pressure (psi)	Burst Pressure (psi)	Price
3205-0170	6	14	360	1160	£307.36
3205-0171	8	16	360	1160	£327.71
3205-0172	10	18	360	1160	£344.67
3205-0173	13	21	360	1160	£409.13
3205-0174	16	25	360	1160	£546.18
3205-0175	19	29	360	1160	£628.28
3205-0176	25	37	360	1160	£980.41

Premium™ Fuel Master SD

Industrial Hose

Tube: Nitrile (NBR) based

Reinforcement: Steel wire

Cover: CR (Chloroprene) based



Temperature Range:
-30°C to +90°C

40 m
COIL



Working Pressure:
920 psi



- Recommended for general industrial applications such as mineral oils and fuel mixtures
- Resistance to weather and abrasion

PGC: 650	ID (mm)	OD (mm)	Working Pressure (psi)	Burst Pressure (psi)	Price
4688-14001	19	31	230	920	£781.28
4688-14003	25	37	230	920	£878.74
4688-14005	32	44	230	920	£1049.39
4688-14007	38	51	230	920	£1317.90
4688-14009	50	66	230	920	£2099.59
4688-14010	51	67	230	920	£2099.59
4688-14012	63	79	230	920	£2489.82
4688-14013	75	91	230	920	£3149.39
4688-14014	76	92	230	920	£3149.39
4688-14016	100	116	230	920	£4598.04
4688-14017	102	118	230	920	£4598.04
4688-14019	127	147	230	920	£6241.20
4688-14020	152	174	230	920	£8388.48

Steam Hose

Premium™ Steam Master Red

Steam Hose

Tube: Black EPDM

Reinforcement: Twin steel braids

Cover: EPDM rubber based pinpricked



Temperature Range:
up to +210°C

40 m
COIL



Working Pressure:
260 psi



- Recommended for use with pressurised saturated steam
- Resistance to weather
- Standards: EN ISO 6134:2005-2A

PGC: 651	ID (mm)	OD (mm)	Working Pressure (psi)	Burst Pressure (psi)	Price
3602-12001	13	25	260	2600	£666.46
3602-12002	16	30	260	2600	£795.90
3602-12003	19	33	260	2600	£871.75
3602-12004	25	40	260	2600	£1051.76
3602-12005	32	48	260	2600	£1667.22
3602-12006	38	54	260	2600	£1821.08
3602-12007	51	67	260	2600	£2563.36

Essential™ Oil Master Lite SD

Industrial Hose

Tube: Nitrile (NBR) based

Reinforcement: Steel wire

Cover: CR (Chloroprene) based



Temperature Range:
-30°C to +100°C

40 m
COIL



Working Pressure:
145 psi



- Recommended for general industrial applications such as mineral oils and fuel mixtures
- Resistance to weather and abrasion

PGC: 650	ID (mm)	OD (mm)	Working Pressure (psi)	Burst Pressure (psi)	Price
4688-14101	19	29	145	435	£522.62
4688-14102	25	35	145	435	£551.38
4688-14103	32	42	145	435	£713.53
4688-14104	38	48	145	435	£747.09
4688-14105	51	61	145	435	£846.47
4688-14106	65	77	145	435	£1267.09
4688-14107	76	88	145	435	£1388.69
4688-14108	90	104	145	435	£2176.75
4688-14109	100	114	145	435	£2321.46
4688-14110	127	143	145	435	£3589.84
4688-14111	152	168	145	435	£5315.46

Premium™ Heater Master

Steam Hose

Tube: Black EPDM

Reinforcement: Twin steel braids

Cover: EPDM rubber pinpricked



Temperature Range:
-20°C to +164°C

40 m
COIL



Working Pressure:
Steam/Water
85/290 psi



- Recommended for use with hot water and steam
- High resistance to weather
- Standards: BS 5122/A2

PGC: 651	ID (mm)	OD (mm)	Working Pressure (psi) Steam/Water	Burst Pressure (psi)	Price
3213-11001	13	25	85/290	870	£512.59
3213-11002	16	30	85/290	870	£632.45
3213-11003	19	33	85/290	870	£732.27
3213-11004	25	40	85/290	870	£805.49
3213-11005	32	48	85/290	870	£976.79
3213-11006	38	54	85/290	870	£1342.49
3213-11007	51	67	85/290	870	£1703.83

Acid Chemical Hose

02

Premium™ Chem Master XLPE SD

Acid Chemical Hose

Tube: PEX (XLPE)

Reinforcement: Steel wire

Cover: EPDM rubber



Temperature Range:
-20°C to +65°C



Working Pressure:
15 bar (230 psi)

40 m COIL



- Recommended for use with tank truck, barge, ship or storage tank transfer of chemical products
- Resistance to weather

PGC: 652	ID (mm)	OD (mm)	Working Pressure (psi)	Burst Pressure (psi)	Price
4695-13001	19	31	230	690	£903.13
4695-13002	25	37	230	690	£952.39
4695-13003	32	44	230	690	£1245.29
4695-13004	38	51	230	690	£1366.90
4695-13005	50	66	230	690	£1855.07
4695-13006	51	67	230	690	£1855.07
4695-13007	65	81	230	690	£2782.62
4695-13008	75	91	230	690	£3490.91
4695-13009	76	92	230	690	£3490.91
4695-13010	100	116	230	690	£4637.68

Premium™ Chem Master UHMWPE SD

Acid Chemical Hose

Tube: UHMWPE

Reinforcement: Steel wire

Cover: CSM rubber



Temperature Range:
-35°C to +100°C



Working Pressure:
15 bar (230 psi)

40 m COIL



- Recommended for use with corrosive chemicals and acids
- Resistance to weather and abrasion and chemicals and oils
- Standards: EN 12115

PGC: 652	ID (mm)	OD (mm)	Working Pressure (psi)	Burst Pressure (psi)	Price
4697-11001	13	23	230	920	£854.31
4697-11002	19	31	230	920	£976.79
4697-11003	25	37	230	920	£1025.18
4697-11004	32	44	230	920	£1342.49
4697-11005	38	51	230	920	£1586.58
4697-11006	50	66	230	920	£2001.96
4697-11007	51	67	230	920	£2001.96
4697-11008	63	79	230	920	£3417.67
4697-11009	75	91	230	920	£4027.89
4697-11010	100	116	230	920	£5687.70
4697-11011	101.5	118	230	920	£5687.70

Premium™ Chem Master EPDM SD

Acid Chemical Hose

Tube: EPDM rubber

Reinforcement: Steel wire

Cover: CSM rubber



Temperature Range:
-40°C to +95°C



Working Pressure:
15 bar (230 psi)

40 m COIL



- Recommended for use with chemical products such as acids, alkalis, esters and ketones with low or medium concentration
- Resistance to weather and abrasion
- Standards: EN 12115

PGC: 652	ID (mm)	OD (mm)	Working Pressure (psi)	Burst Pressure (psi)	Price
4696-11051	19	31	230	920	£810.56
4696-11052	25	37	230	920	£886.55
4696-11053	32	44	230	920	£1266.95
4696-11054	38	51	230	920	£1646.45
4696-11055	50	66	230	920	£2001.07
4696-11056	51	67	230	920	£2001.07
4696-11057	63	79	230	920	£2533.00
4696-11058	75	91	230	920	£3115.59
4696-11059	76	92	230	920	£3115.59
4696-11060	100	116	230	920	£4306.54
4696-11061	101.5	118	230	920	£4306.54
4696-11062	152	174	230	920	£6332.94

Food and Beverage Hose

Premium™ Dairy Master Lite SD

Food and Beverage Hose

Tube: NBR based

Reinforcement: Steel wire

Cover: NBR rubber



Temperature Range:
-30°C to +90°C



Working Pressure:
10 bar (145 psi)

40 m COIL



- Recommended for use with food products such as fats and oils needing a FDA sanitary hose and dairy products
- Resistance to weather and abrasion and chemicals and oils
- Standards: FDA, BFR, and Animal Derived Ingredients Free

PGC: 652	ID (mm)	OD (mm)	Working Pressure (psi)	Burst Pressure (psi)	Price
3131-11051	32	43	145	435	£918.39
3131-11052	38	49	145	435	£1173.37
3131-11053	40	51	145	435	£1291.49
3131-11054	45	56	145	435	£1509.00
3131-11055	51	63	145	435	£1820.64
3131-11056	63	76	145	435	£2317.10
3131-11057	76	89	145	435	£2746.87
3131-11058	102	116	145	435	£3767.24



Premium™ Washdown Master

Food and Beverage Hose
Tube: EPDM based
Reinforcement: Textile cords
Cover: EPDM rubber

Temperature Range: -30°C to +164°C

Working Pressure: 6 bar (85 psi)

40 m COIL

- Recommended for use with paper mill, food handling or processing plant washdown
- Standards: FDA, Animal Derived Ingredients Free

PGC: 653	ID (mm)	OD (mm)	Working Pressure (psi)	Burst Pressure (psi)	Price
3213-11051	10	18	85	870	£463.78
3213-11052	13	23	85	870	£585.82
3213-11053	16	26	85	870	£732.27
3213-11054	19	31	85	870	£854.31
3213-11055	25	37	85	870	£1049.58
3213-11056	32	45	85	870	£1293.67
3213-11057	38	52	85	870	£1538.20
3213-11058	51	65	85	870	£1830.67

Essential™ Water Master D

Water Hose
Tube: EPDM based
Reinforcement: Steel wire
Cover: EPDM rubber

Temperature Range: -35°C to +95°C

Working Pressure: 10 bar (145 psi)

40 m COIL



- Recommended for use with water, mud and slurry in heavy duty service
- Pressure hose
- Weather and aging resistant

PGC: 654	ID (mm)	OD (mm)	Working Pressure (psi)	Burst Pressure (psi)	Price
3137-12001	25	35	145	435	£428.06
3137-12003	32	42	145	435	£562.53
3137-12005	38	48	145	435	£675.61
3137-12006	51	63	145	435	£855.71
3137-12008	63	76	145	435	£1148.49
3137-12010	76	89	145	435	£1351.21
3137-12011	102	116	145	435	£1553.93
3137-12013	127	142	145	435	£2252.15
3137-12014	152	169	145	435	£2972.16
3137-12015	203	224	145	435	£4323.36



Premium™ Beverage Master D

Food and Beverage Hose
Tube: CR/NR based
Reinforcement: Synthetic textile
Cover: EPDM rubber

Temperature Range: -30°C to +90°C

Working Pressure: 16 bar (230 psi)

40 m COIL

- Recommended for use with liquid food including alcoholic beverages, pharmaceuticals, cosmetics or water based products requiring FDA sanitary hose
- Standards: FDA, BfR, and Animal Derived Ingredients Free

PGC: 653	ID (mm)	OD (mm)	Working Pressure (psi)	Burst Pressure (psi)	Price
3132-16001	13	21	230	690	£709.17
3132-16002	19	29	230	690	£851.26
3132-16003	25	37	230	690	£1028.66
3132-16004	32	44	230	690	£1095.79
3132-16005	38	51	230	690	£1213.48
3132-16006	40	53	230	690	£1364.28
3132-16007	51	65	230	690	£2008.50
3132-16008	63	77	230	690	£2333.67
3132-16009	76	92	230	690	£2929.50
3132-16010	80	96	230	690	£3079.87
3132-16011	102	118	230	690	£3426.39

Essential™ Water Master SD

Water Hose
Tube: EPDM based
Reinforcement: Steel wire
Cover: EPDM rubber

Temperature Range: -35°C to +95°C

Working Pressure: 10 bar (145 psi)

40 m COIL



- Recommended for use with water, mud and slurry in heavy duty service
- Vacuum and pressure hose
- Weather and aging resistant

PGC: 654	ID (mm)	OD (mm)	Working Pressure (psi)	Burst Pressure (psi)	Price
4686-12001	25	35	145	435	£518.12
4686-12003	32	42	145	435	£630.37
4686-12005	38	48	145	435	£765.66
4686-12007	51	63	145	435	£945.76
4686-12009	63	76	145	435	£1215.92
4686-12011	76	89	145	435	£1463.88
4686-12013	102	116	145	435	£1576.55
4686-12015	127	142	145	435	£2477.07
4686-12016	152	169	145	435	£3197.50
4686-12017	203	224	145	435	£4796.24

Material Handling Hose

Essential™ Sandblast Master D

Material Handling Hose

Tube: NR/BR based
Reinforcement: Synthetic textile cord
Cover: NR/BR based

Temperature Range:
-40°C to +75°C

Working Pressure:
170 psi

40 m
COIL



- Recommended for sandblasting of metal castings, steel, stone sand and cement
- Resistant to weather and abrasion
- Standards: DIN 53516

PGC: 655	ID (mm)	OD (mm)	Working Pressure (psi)	Burst Pressure (psi)	Price
4129-11001	19	34	170	690	£495.75
4129-11002	25	40	170	690	£562.69
4129-11003	32	48	170	690	£697.93
4129-11004	38	56	170	690	£900.57

Essential™ Silo Master SD

Material Handling Hose

Tube: NR/BR based rubber
Reinforcement: Steel wire helix
Cover: NR/BR based rubber

Temperature Range:
-20°C to +80°C

Working Pressure:
115 psi

40 m
COIL



- Recommended for pneumatic transport of abrasive materials and bulk food such as plastic granules, grain and sugar
- Vacuum and pressure hose resistant to weather and abrasion

PGC: 655	ID (mm)	OD (mm)	Working Pressure (psi)	Burst Pressure (psi)	Price
4693-13051	51	67	115	345	£1367.37
4693-13052	63	81	115	345	£1964.43
4693-13053	76	96	115	345	£2278.79
4693-13054	80	100	115	345	£2518.98
4693-13055	90	110	115	345	£3036.43
4693-13056	102	122	115	345	£3294.25
4693-13057	110	132	115	345	£3414.57
4693-13058	127	149	115	345	£3681.89
4693-13059	152	175	115	345	£4344.54
4693-13060	203	228	115	345	£6142.96

Essential™ Cement Master SD

Material Handling Hose

Tube: NR/BR based rubber
Reinforcement: Steel wire helix
Cover: NR/BR based rubber

Temperature Range:
-20°C to +80°C

Working Pressure:
115 psi

40 m
COIL



- Recommended for pneumatic transport of dry cement, slurries, dust, limestone, woodchips, coal, sand, gravel ground slate and metal shavings
- Vacuum and pressure hose resistant to weather and abrasion
- Standards: DIN 53516

PGC: 655	ID (mm)	OD (mm)	Working Pressure (psi)	Burst Pressure (psi)	Price
4691-16051	51	67	115	345	£1306.31
4691-16052	63	81	115	345	£1711.13
4691-16053	76	96	115	345	£1914.22
4691-16054	80	100	115	345	£2139.03
4691-16055	90	110	115	345	£2656.93
4691-16056	102	122	115	345	£2882.19
4691-16057	110	132	115	345	£3224.14
4691-16058	127	149	115	345	£3638.47
4691-16059	152	175	115	345	£4260.41
4691-16060	203	228	115	345	£5941.68

Essential™ Concrete Master D

Material Handling Hose

Tube: NR/BR/SBR based rubber
Reinforcement: Synthetic textile cord
Cover: NR/BR based rubber

Temperature Range:
-20°C to +70°C

Working Pressure:
115 psi

40 m
COIL



- Concrete pump hose for abrasive substances such as concrete mortar, cement, plaster, grout and cement applications, handling a multitude of materials being pumped to concrete structures, tunnel faces, swimming pools
- Vacuum and pressure hose resistant to weather and abrasion
- Standards: DIN 53516

PGC: 655	ID (mm)	OD (mm)	Working Pressure (psi)	Burst Pressure (psi)	Price
4129-11051	19	31	115	345	£450.52
4129-11052	25	39	115	345	£562.69
4129-11053	32	47	115	345	£787.95
4129-11054	35	50	115	345	£855.79
4129-11055	38	54	115	345	£968.42
4129-11056	50	68	115	345	£1080.60
4129-11057	63	83	115	345	£1643.74

Water Hose

1JC Jetclean™ Pressure Wash Hose

1-Wire Pressure Wash Hose
Tube: NBR (Nitrile) based
Reinforcement: High Tensile Steel Braid
Cover: NBR/PVC based in black, blue and grey

40 m
COIL



Temperature Range:
-40°C to +155°C



Working Pressure:
2900 psi



Not recommended for steam service.



- Recommended for use on hot or cold water high pressure cleaning equipment
- Grey and blue are suitable for use in hospitals, swimming pools and other applications where hygiene is of the upmost importance
- For use with no-skive MegaCrimp® Couplings
- Not recommended for steam service

PGC: 373	OD (")	OD (mm)	Working Pressure (psi)	Burst Pressure (psi)	Price
1JC05B	5/16	15.1	2900	12400	£17.77
1JC06B	3/8	17.1	2900	10400	£19.90
1JC08B	1/2	15.1	2900	12400	£25.76

2JC Jetclean™ Pressure Wash Hose

2-Wire Pressure Wash Hose
Tube: NBR (Nitrile) based
Reinforcement: High Tensile Steel Braid
Cover: NBR/PVC based in black, blue and grey

40 m
COIL



Temperature Range:
-40°C to +155°C



Working Pressure:
5800 psi



Not recommended for steam service.



- Recommended for use on hot or cold water high pressure cleaning equipment
- Grey and blue are suitable for use in hospitals, swimming pools and other applications where hygiene is of the upmost importance
- For use with no-skive MegaCrimp® Couplings
- Not recommended for steam service

PGC: 373	OD (")	OD (mm)	Working Pressure (psi)	Burst Pressure (psi)	Price
2JC05B	5/16	16.3	5800	20300	£21.92
2JC06B	3/8	18.8	5800	19200	£25.76
2JC08B	1/2	16.3	5800	20300	£30.20

Powerclean Pressure Wash Hose

Material Handling Hose
Tube: NRB (Nitrile) based
Reinforcement: 1 or 2 High Tensile Steel Braid
Cover: NBR (Nitrile) based

40 m
COIL



Temperature Range:
-40°C to +121



Working Pressure:
115 psi



Not recommended for steam service.



- Recommended for pressure cleaning equipment especially high pressure water service
- For use with no-skive MegaCrimp® Couplings
- Not recommended for steam service

PGC: 373	ID (")	OD (mm)	Working Pressure (psi)	Burst Pressure (psi)	Price
5PC3600B	5/16	3600	3600	14400	£16.61
5PC5000B	5/16	5000	5000	19200	£20.48
6PC3000B	3/8	3000	3000	12000	£18.59
6PC5000B	3/8	5000	5000	19200	£24.08
8PC2500B	1/2	2500	2500	9300	£24.08
8PC4000B	1/2	4000	4000	16000	£28.22



A Tomkins Company

Self-Assembly System

A Complete Range with a Solution for Every Need

Gates range of self-assembly machinery covers the spectrum of needs from workshops to on-site field-crimping and even mobile service operations. Fast and factory-quality assembly of the complete Global range of Gates hose and couplings is at your fingertips.

The Gates Integrated System offers superior hose and couplings with rigorously validated optimal crimping machines and settings to produce hose assemblies which perform above and beyond any international standard.

A wide range of precision tools, reference material and accessories to facilitate the assembly operation and promote compliance to European legislation.

The right machine for your service operation – from fully equipped to fully mobile.

Innovative self-assembly machines and dies, rigorously validated



The newest Gates range of grease-free self-assembly machines and dies are custom designed to work with Gates Global hoses and couplings. Gates dies are characterised by a proprietary profile design for an optimal cylindrical crimp. They are tried, tested and validated to provide you with the most optimal crimp settings. Furthermore, Gates die sets are logically organised to facilitate die selection time after time.

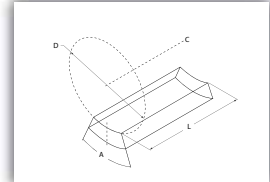

Machine	Die Set	Pressure	Flow	Temp	Material	Length	Weight	Volume	Power	Speed	Capacity	Notes
...

Optimal crimp data derived from meticulous testing

Each Gates crimper comes with validated crimp settings for the complete Global hose and coupling product range. No need for time consuming trial-and-error to find the ideal settings.

The result: factory-quality performance above and beyond all international standards in full compliance with EU directives

When Gates Global hoses and couplings are crimped in accordance with the Gates Integrated System Approach, they yield factory-quality assemblies fully compliant with European Directives and legislation exceeding all international standards. Gates Global wire-braid hose and MegaCrimp® coupling assemblies are developed to withstand impulse testing to 600,000 cycles. Gates spiral wire hose and GS coupling assemblies even go to a million cycles. This ensures you can rely on Gates assemblies to go the long road.



WORKSHOP

In the Gates workshop, safe, fast and efficient assembly of hydraulic hoses and couplings is made simple. All machines are custom-designed to work with a well-defined range of Gates hoses and couplings allowing production of factory-quality assemblies fully complying with European Directives and the most stringent international standards.

No matter what your workshop needs, whether you are a starter, a professional, or a full-service workshop, Gates has the right product offering for you.



MOBILE SERVICE

A Gates hose assembly is much more than the sum of its components. It is the combined result of a rigorous test regime and of a tightly controlled manufacturing process, both at Gates and at the point of assembly. To reduce the risk of premature failure due to variations in the assembly process, Gates has developed a special proposition for mobile service operations allowing them to benefit from the simplified and superior Global range of no-skive hoses and couplings.

And thanks to the Gates Integrated System, mobile service operators can offer their customers the superior quality and performance which make the world's most trusted hose assemblies.



FIELD SERVICE

In the field, every minute counts. In today's environment, equipment, whether it be agricultural, construction or mining, simply cannot afford unnecessary downtime. That's why Gates has developed a range of small, portable and easy to use crimpers specifically designed for end-users on site.

And since these simple, lightweight machines are designed as part of the Gates Integrated System, end-users are assured of factory quality no-skive assemblies – even in the field!



Cutting Machines

MXK 25
Compact Cutting Machine



- Compact cutting machine
- Perfect for the small workshop
- Cuts up to 1 1/4" four spiral wire hose

PGC: 378	Power Supply	Price
7480-19189	12 V DC	£1496.05
7480-19190	220 V 1 Phase	£997.37

MXK 30
Cutting Machine



- Robust cutter
- Suitable for all types of workshops
- Cuts up to 1 1/4" six spiral wire hose

PGC: 378	Power Supply	Price
7480-19191	380 V 3 Phase	£2244.08

MXK 50
Heavy Duty Cutting Machine



- Heavy-duty hose cutter
- Quick and reliable production across all hose size ranges
- Cuts up to 2" six spiral wire hose

PGC: 378	Power Supply	Price
7480-19192	380 V 3 Phase	£5610.19

Cutter Specifications		MXK 25		MXK 30	MXK 50
		DC	1 Phase	3 Phase	3 Phase
Power Supply		12 V	220 V	380 V	380 V
Maximum Capacity	WB	1 1/4	1 1/4	1 1/4	2
	4SW	1 1/4	1 1/4	1 1/4	2
	6SW	--	--	1 1/4	2
Motor (kW)		2	2.2	3	4.6
Brake Motor		--	--	x	x
Suction Connection (mm)		--	40	80	60
Cutting Blade		250 x 2.5 x 40	200 x 1.6 x 30	275 x 3 x 30	400 x 4 x 30
Dimensions (mm)	H	365	540	300	478
	W	567	510	440	677
	L	470	400	540	868
Weight (Kg)		29	20	50	130
Product Number		7480-19189	7480-19190	7480-19191	7480-19192

Crimping Machines

MCX 25
Compact Crimping Machine



- Compact crimper for low-volume production
- Ideal as starter machine or for small work shops
- Crimps no-skive GlobalSpiral™ couplings up to 1" and no-skive MegaCrimp® couplings for wire-braid hose up to 1 1/4"

PGC: 378	Power Supply	Price
7480-19182	12 V DC	£4114.14
7480-19183	220 V 1 Phase	£4114.14
7480-19184	380 V 3 Phase	£4114.14

MCX 30
Compact Crimping Machine



- Compact, operator-friendly machine to crimp the complete Gates range up to 1 1/4"
- Optional foot pedal for hands-free operation

PGC: 378	Power Supply	Price
7480-19185	12 V DC	£5610.19
7480-19186	220 V 1 Phase	£5610.19
7480-19187	380 V 3 Phase	£5610.19

Crimper Specifications		MCX 25			MCX 30		
		DC	1 Phase	3 Phase	DC	1 Phase	3 Phase
Power Supply		12 V	220 V	380 V	12 V	220 V	380 V
Maximum Capacity	WB	1 1/4	1 1/4	1 1/4	1 1/4	1 1/4	1 1/4
	4SW	1	1	1	1 1/4	1 1/4	1 1/4
	6SW	--	--	--	1 1/4	1 1/4	1 1/4
Crimping Force (ton)		130	130	130	190	190	190
Motor (kW)		1.6	2.2	4	1.6	2.2	4
Die Set		239-Dxx	239-Dxx	239-Dxx	239-Dxx	239-Dxx	239-Dxx
Cycle Time (sec)		39	39	19	41	41	20
Die Storage		rack	rack	rack	rack	rack	rack
Dimensions (mm)	H	550	790	790	550	790	790
	W	475	600	600	475	600	600
	L	395	550	550	395	550	550
Weight (Kg)		115	160	160	125	170	170
Product Number		7480-19182	7480-19183	7480-19184	7480-19185	7480-19186	7480-19187

Tools

MegaCrimp® Vernier Caliper



- A handy tool which measures finished outside diameters
- Specially designed to allow easy measuring of the finished diameters on -4, -5 and -6 MegaCrimp® case

PGC: 378	Price
7369-0322	£31.57

MegaCrimp® Insertion Tool



- The MegaCrimp® coupling insertion tool offers an easy way to confirm the right insertion depth for all Gates wire-braid hydraulic hoses
- Also verifies the squareness of cut

PGC: 378	Price
7482-1342	£123.96

- MCX 25 and MCX 30 crimpers are equipped with a die set storage rack allowing for logically organised die storage within easy reach of the operator, thus speeding up die selection and assembly
- Also available for mobile service with separate DC power pack



High Pressure Valves

02

MHA ZENTGRAF

FlowControl Technology

MHA Zentgraf is one of Europe's leading manufacturers of ball and flow control valves for use with high pressure hydraulic applications. The MHA range of valves has a proven track record for ultra-high pressure applications up to 800 bar (11,600 psi). Ball valve performance to the highest standards has been achieved and is maintained by using superior quality MHA specified materials.

In order to provide the many advantages of ball valves in high temperature applications, MHA has developed the MKHT series of ball valves. These valves are designed with a gland packing of special material. This sealing allows applications with high pressure and simultaneously high temperatures. MHA shut-off valves are designed to function safely in extreme conditions providing:

- Stainless steel and carbon steel construction
- Secure operation
- Reliable sealing in shut-off position and to the outside

MNA Zentgraf is certified according to the Pressure Equipment Directive (CE) and DIN EN ISO 9001 : 2000. MHA-Protect is a galvanic Chrome-VI free surface plating.



Temperature Range:
-20°C to +100°C



Working Pressure:
25 bar (362 psi) to 500 bar (7252 psi)
according to BSPP/NPT
(listed in tables below)



2-Way Ball Valves

2-Way Ball Valve

BKH Series
DIN 2353 Light



- Carbon steel
- Brass ball
- NBR seal
- POM seat ball

PGC: 253	OD (mm)	Price
BV6LHPS	6	£25.26
BV8LHPS	8	£24.62
BV10LHPS	10	£25.43
BV12LHPS	12	£25.93
BV15LHPS	15	£29.06
BV18LHPS	18	£29.89
BV22LHPS	22	£59.43
BV28LHPS	28	£78.58
BV35LHPS	35	£78.58
BV42LHPS	42	£174.47

2-Way Ball Valve

Body Only
BKH Series
DIN 2353 Light



- Carbon steel
- Brass ball
- NBR seal
- POM seat ball

PGC: 253	OD (mm)	Price
XBV6LHPS	6	£23.63
XBV8LHPS	8	£22.95
XBV10LHPS	10	£23.54
XBV12LHPS	12	£23.56
XBV15LHPS	15	£26.06
XBV18LHPS	18	£24.92
XBV22LHPS	22	£52.64
XBV28LHPS	28	£67.26
XBV35LHPS	35	£63.57
XBV42LHPS	42	£151.74

2-Way Ball Valve

BKH Series
DIN 2353 Heavy



- Carbon steel
- Brass ball
- NBR seal
- POM Seat ball

PGC: 253	OD (mm)	Price
BV8SHPS	8	£27.57
BV10SHPS	10	£26.75
BV12SHPS	12	£24.62
BV14SHPS	14	£29.89
BV16SHPS	16	£29.06
BV20SHPS	20	£39.46
BV25SHPS	25	£58.11
BV30SHPS	30	£76.60
BV38SHPS	38	£92.77

2-Way Ball Valve

Body Only
BKH Series
DIN 2353 Heavy



- Carbon steel
- Brass ball
- NBR seal
- POM seat ball

PGC: 253	OD (mm)	Price
XBV8SHPS	8	£25.64
XBV10SHPS	10	£24.43
XBV12SHPS	12	£21.92
XBV14SHPS	14	£25.53
XBV16SHPS	16	£23.78
XBV20SHPS	20	£31.97
XBV25SHPS	25	£45.22
XBV30SHPS	30	£60.61
XBV38SHPS	38	£69.66

Multiway Ball Valves

2-Way Ball Valve

BKH Series
Female Thread BSPP



- Stainless steel
- Steel ball
- NBR seal
- POM seat ball

PGC: 253	BSPP	Working Pressure (bar)	Price
BV2HPS-SS	1/8	500	£242.82
BV4HPS-SS	1/4	500	£165.79
BV6HPS-SS	3/8	500	£176.06
BV8HPS-SS	1/2	500	£193.49
BV12HPS-SS	3/4	315	£374.86
BV16HPS-SS	1	315	£407.33
BV20HPS-SS	1 1/4	315	£511.29
BV24HPS-SS	1 1/2	315	£809.67

2-Way Ball Valve

BKH Series
Female Thread NPT



- Carbon steel
- Brass ball
- NBR seal
- POM seat ball

PGC: 253	NPT	Working Pressure (bar)	Price
BV4HPS-NPT	1/4	500	£23.39
BV6HPS-NPT	3/8	500	£24.90
BV8HPS-NPT	1/2	500	£27.88
BV12HPS-NPT	3/4	400	£58.17
BV16HPS-NPT	1	350	£72.86
BV20HPS-NPT	1 1/4	315	£88.29
BV24HPS-NPT	1 1/2	315	£105.23

3-Way Ball Valve

3KH Series L Port
Female Thread BSPP



- Carbon steel
- Steel ball
- NBR seal
- POM seat ball

PGC: 253	BSPP	Working Pressure (bar)	Price
BV2HPS-3KH-L	1/8	500	£253.82
BV4HPS-3KH-L	1/4	500	£253.82
BV6HPS-3KH-L	3/8	500	£296.55
BV8HPS-3KH-L	1/2	400	£399.61
BV12HPS-3KH-L	3/4	315	£685.89
BV16HPS-3KH-L	1	315	£789.86
BV20HPS-3KH-L	1 1/4	315	£956.57
BV24HPS-3KH-L	1 1/2	250	£1045.87

2-Way Ball Valve

BKH Series
Female Thread BSPP



- Carbon steel
- Brass ball
- NBR seal
- POM seat ball
- 1 1/4" & 1 1/2" BSPP are DN25 reduced bore

PGC: 253	BSPP	Working Pressure (bar)	Price
BV2HPS	1/8	500	£28.24
BV4HPS	1/4	500	£19.00
BV6HPS	3/8	500	£21.80
BV8HPS	1/2	500	£23.78
BV12HPS	3/4	315	£44.41
BV16HPS	1	315	£59.43
BV20HPS	1 1/4	315	£75.93
BV24HPS	1 1/2	315	£84.19

2-Way Ball Valve

MKH Series
Female Thread BSPP



- Carbon steel
- Steel ball
- NBR seal
- POM seat ball

PGC: 253	BSPP	Working Pressure (bar)	Price
BV20FB-HPS	1 1/4	420	£185.20
BV24FB-HPS	1 1/2	420	£288.03
BV32FB-HPS	2	420	£336.23

3-Way Ball Valve

3KH Series T Port
Female Thread BSPP



- Carbon steel
- Steel ball
- NBR seal
- POM seat ball

PGC: 253	BSPP	Working Pressure (bar)	Price
BV2HPS-3KH-T	1/8	500	£282.81
BV4HPS-3KH-T	1/4	500	£282.81
BV6HPS-3KH-T	3/8	500	£326.25
BV8HPS-3KH-T	1/2	400	£439.41
BV12HPS-3KH-T	3/4	315	£754.47
BV16HPS-3KH-T	1	315	£868.90
BV20HPS-3KH-T	1 1/4	315	£1052.29
BV24HPS-3KH-T	1 1/2	250	£1150.40



4-Way Ball Valve

4KH Series T Port
Female Thread BSPP



- Carbon steel
- Steel ball
- NBR seal
- POM seat ball

PGC: 253	BSPP	Working Pressure (bar)	Price
BV2HPS-4KH-T	1/8	500	£282.81
BV4HPS-4KH-T	1/4	500	£326.25
BV6HPS-4KH-T	3/8	500	£326.25
BV8HPS-4KH-T	1/2	400	£439.41
BV12HPS-4KH-T	3/4	315	£754.47
BV16HPS-4KH-T	1	315	£868.90
BV20HPS-4KH-T	1 1/4	315	£1052.29
BV24HPS-4KH-T	1 1/2	250	£1150.40

4-Way Ball Valve

4KH Series X Port
Female Thread BSPP



- Carbon steel
- Steel ball
- NBR seal
- POM seat ball

PGC: 253	BSPP	Working Pressure (bar)	Price
BV2HPS-4KH-X	1/8	500	£253.82
BV4HPS-4KH-X	1/4	500	£253.82
BV6HPS-4KH-X	3/8	500	£296.55
BV8HPS-4KH-X	1/2	400	£399.61
BV12HPS-4KH-X	3/4	315	£685.89
BV16HPS-4KH-X	1	315	£789.86
BV20HPS-4KH-X	1 1/4	315	£956.57
BV24HPS-4KH-X	1 1/2	250	£1045.87

3-Way Diverters

3-Way Diverter

BK3 Series T Port
Female Thread BSPP



- Pressure inlet only from middle port
- Carbon steel
- Steel ball
- NBR seal
- POM seat ball

PGC: 253	BSPP	Working Pressure (bar)	Price
BV4HPS-3T	1/4	500	£77.63
BV6HPS-3T	3/8	500	£101.03
BV8HPS-3T	1/2	500	£106.89
BV12HPS-3T	3/4	315	£228.52
BV16HPS-3T	1	315	£282.01

3-Way Diverter

BK3 Series L Port
Female Thread BSPP



- Pressure inlet only from middle port
- Carbon steel
- Steel ball
- NBR seal
- POM seat ball

PGC: 253	BSPP	Working Pressure (bar)	Price
BV4HPS-3L	1/4	500	£46.72
BV6HPS-3L	3/8	500	£46.72
BV8HPS-3L	1/2	500	£54.48
BV12HPS-3L	3/4	315	£97.23
BV16HPS-3L	1	315	£120.50
BV20HPS-3L	1 1/4	315	£396.96
BV24HPS-3L	1 1/2	250	£698.01
BV32HPS-3L	2	250	£930.72



Applications in hydraulics for:

- Construction industry
- Agricultural machinery
- Construction industry
- Water engineering
- Mining industry
- Paint industry



Temperature Range:
-20°C to +120°C



Working Pressure:
351 bar (4500 psi) to
500 bar (7252 psi)
according to BSPP/
NPT
(listed in tables below)

Hydraulic Ball Valves

Hydraulic Ball Valve

Female Thread BSPP



- Carbon steel body
- Carbon steel ball
- NBR seal
- POM seat ball

PGC: 253	BSPP	Working Pressure (bar)	Price
HBV1/4	1/4	500	£14.10
HBV3/8	3/8	500	£17.45
HBV1/2	1/2	500	£20.00
HBV3/4	3/4	315	£34.55
HBV1	1	315	£47.90
HBV11/4	1 1/4	315	£87.00
HBV11/2	1 1/2	315	£124.55

Hydraulic Ball Valve

Female Thread NPT



- Carbon steel body
- Carbon steel ball
- NBR seal
- POM seat ball

PGC: 253	NPT	Working Pressure (bar)	Price
HBV1/4N	1/4	500	£14.10
HBV3/8N	3/8	500	£17.45
HBV1/2N	1/2	500	£20.00
HBV3/4N	3/4	315	£34.55
HBV1N	1	315	£47.90
HBV11/4N	1 1/4	315	£87.00
HBV11/2N	1 1/2	315	£124.55



Needle Valves

NDRV Series

- Single acting
- Flow control with free reverse flow

NDV Series

- Double acting
- Flow control and shut-off

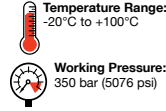

Needle Valve
NDRV Series
NBR Seal
Female Thread BSPP



- Single acting
- Flow control with free reverse flow
- Stainless steel with nylon control knob

PGC: 253	BSPP	Max. Flow (lpm)	Max. Rev. Flow (lpm)	Price
FCV2-NDVR-SS	1/8	10	15	£265.76
FCV4-NDVR-SS	1/4	50	70	£193.22
FCV6-NDVR-SS	3/8	75	100	£242.07
FCV8-NDVR-SS	1/2	140	150	£285.33
FCV12-NDVR-SS	3/4	175	200	£411.70
FCV16-NDVR-SS	1	350	275	£798.09
FCV20-NDVR-SS	1 1/4	350	400	£616.05
FCV24-NDVR-SS	1 1/2	350	520	£698.84
FCV32-NDVR-SS	2	350	600	£764.50

Needle Valve
NDV Series
NBR Seal
Female Thread BSPP



- Double acting
- Flow control and shut-off valve
- Stainless steel with nylon control knob

PGC: 253	BSPP	Max. Flow (lpm)	Price
FCV2-NDV-SS	1/8	10	£193.62
FCV4-NDV-SS	1/4	50	£185.14
FCV6-NDV-SS	3/8	75	£192.70
FCV8-NDV-SS	1/2	140	£197.29
FCV12-NDV-SS	3/4	175	£286.15
FCV16-NDV-SS	1	350	£571.46
FCV20-NDV-SS	1 1/4	350	£981.63
FCV24-NDV-SS	1 1/2	350	£1071.55

Needle Valve
NDRV Series
NBR Seal
Female Thread BSPP



- Single acting
- Flow control with free reverse flow
- Carbon steel with nylon control knob

PGC: 253	BSPP	Max. Flow (lpm)	Max. Rev. Flow (lpm)	Price
FCV2-NDVR	1/8	10	15	£111.26
FCV4-NDVR	1/4	50	70	£45.96
FCV6-NDVR	3/8	75	100	£51.33
FCV8-NDVR	1/2	140	150	£68.73
FCV12-NDVR	3/4	175	200	£121.86
FCV16-NDVR	1	350	275	£293.23
FCV20-NDVR	1 1/4	350	400	£346.74
FCV24-NDVR	1 1/2	350	520	£455.80
FCV32-NDVR	2	350	600	£612.60

Needle Valve
NDV Series
NBR Seal
Female Thread BSPP



- Double acting
- Flow control and shut-off valve
- Carbon steel with nylon control knob

PGC: 253	BSPP	Max. Flow (lpm)	Price
FCV2-NDV	1/8	10	£101.43
FCV4-NDV	1/4	50	£36.36
FCV6-NDV	3/8	75	£36.91
FCV8-NDV	1/2	140	£43.75
FCV12-NDV	3/4	175	£102.67
FCV16-NDV	1	350	£220.74
FCV20-NDV	1 1/4	350	£309.99
FCV24-NDV	1 1/2	350	£342.57



Modular Hydraulic Filtration Systems

Duramax® Medium Pressure Spin-on Filters

Donaldson Duramax® filters are the highest rated medium pressure filters available in a spin-on configuration for use in hydraulic oil applications.

Duramax® are sturdy, reliable, long-lived and easy to install. Most often used as return-line filters, they are designed for working pressures up to 1000 psi and static pressures up to 2000 psi. As spin-ons, they are particularly well-suited for duplex circuits. Media choices include: Synteq® (synthetic filter media designed by Donaldson specifically for fluid filtration), natural fibre cellulose and stainless steel wire mesh for harsher environments. Available in single- and dual-head designs to accommodate a broad variety of flow ranges.

- Heavy-duty steel body with diecast top plate for added strength
- Head-to-canister O-Ring seal prevents leakage
- BunaN seals are standard; Viton® seals are available on some models
- Operating Temperatures: -29°C to +121°C (synthetic); -29°C to +107°C (cellulose)

Applications:

- Return Lines, Case Drains, Side Loop Systems, Bearing/Gear Lube Systems, Hydrostatic Charge Pumps, Power Transmissions, Cooling Circuits, Fuel Transfer

Duramax® Medium Pressure Spin-On Filter Head

24 bar



Working Pressure:
24 bar (348 psi)

- Filter head, 3.5 bar bypass
- Includes electrical indicator P165194 (1-post DC)

PGC: 460	Size (BSPP)	Price
P761446	1 1/4	£124.43

Spin-On Filter Twin Element

24 bar



- For use with P176446 Spin-On Filter Head, P176155 Dual Spin-On Filter Head

PGC: 460	Flow Rate (lpm)	Media Rating (µm)	Media	Price
P165659	170 / 330	20 Abs	Synteq®	£164.14
P165669	180 / 340	30 Abs	Synteq®	£151.36
P165672	200	> 50 Abs	Synteq®	£168.20

Duramax® Medium Pressure Spin-On Filter Head

34 bar



Working Pressure:
34 bar (493 psi)

- Filter head, 1.7 bar bypass

PGC: 460	Size (BSPP)	Price
P173386	3/4	£103.79

Spin-On Filter Element

34 bar



- For use with P173386 Spin-On Filter Head

PGC: 460	Flow Rate (lpm)	Media Rating (µm)	Media	Price
P164375	110	20 Abs	Synteq®	£71.64
P164381	110	30 Abs	Synteq®	£73.16
P165335	120	> 50 Abs	Synteq®	£85.87

Duramax® Medium Pressure Spin-On Filter Head

34 bar



Working Pressure:
34 bar (493 psi)

- Filter head, 1.7 bar bypass

PGC: 460	Size (BSPP)	Price
P173438	1	£88.86

Spin-On Filter Element

34 bar



- For use with P173438 Spin-On Filter Head

PGC: 460	Flow Rate (lpm)	Media Rating (µm)	Media	Price
P164378	130	20 Abs	Synteq®	£89.37
P164384	130	30 Abs	Synteq®	£80.03
P165338	140	> 50 Abs	Synteq®	£82.99

Medium Pressure Filter

120 bar



Working Pressure:
120 bar (1740 psi)

PGC: 460	Size (BSPP)	Flow Rate (lpm)	Media Rating (µm)	Media	Replacement Element	Price
K020079	1/2	40	10 Abs	Synteq®	P171702	£184.38
K020080	1/2	40	25 Abs	Synteq®	P171703	£184.38

Low Pressure Filters

Low Pressure In-Line Spin-On Return Filter

10 bar



Working Pressure:
10 bar (145 psi)



- Economical, low-pressure, in-line spin-on style return and suction filter head and cartridge
- Die cast aluminium head and steel body ensure strength and durability
- Perfect for a wide variety of mobile and in-plant applications
- Supplied with Synteq® and cellulose media

Applications include:

- Process systems
- Fluid conditioning
- In-plant and mobile equipment
- Power transmissions
- Filter cart

PGC: 460	Size (BSPP)	Flow Rate (lpm)	Media Rating (µm)	Media	Replacement Element	Price
K041150	3/4	40	10 Abs	Synteq®	P171602	£89.65
K040643	3/4	60	10 Nom	Cellulose	P171619	£81.56
K040644	3/4	70	30 Nom	Cellulose	P171611	£81.56
K051386	1 1/4	120	10 Abs	Synteq®	P171613	£129.99
K051279	1 1/4	140	10 Nom	Cellulose	P550148	£111.76
K051280	1 1/4	150	30 Nom	Cellulose	P171616	£109.90
K250068	1 1/2	280	10 Abs	Synteq®	P171613	£286.89
K250033	1 1/2	300	10 Nom	Cellulose	P550148	£223.80
K250070	1 1/2	340	30 Nom	Cellulose	P171616	£264.48

High Pressure Filters

'Last Chance' High Pressure Filter

420 bar



Working Pressure:
1387 bar to 413 bar
(2000 psi to 6000 psi)



- High pressure last chance cartridge
- Heavy duty housing
- Contains Synteq® media

PGC: 460	Size (BSPP)	Flow Rate (lpm)	Media Rating (µm)	Media	Replacement Element	Price
K010005	3/8	2	5 Abs	Synteq®	P171767	£76.74
K020120	1/2	5	5 Abs	Synteq®	P171772	£130.07
K020125	1/2	10	5 Abs	Synteq®	P171777	£142.72
K030300	3/8	2	10 Abs	Synteq®	P171702	£186.58

High Pressure Filter

420 bar



Working Pressure:
420 bar (6090 psi)



- Built to withstand pressures upwards of 6000 psi
- Cast iron head and cold-extruded steel housing for ultimate strength and durability
- Bypass options include 87 psid bypass, bypass with reverse-flow check valve, or no bypass
- Filters contain Synteq®

Applications include:

- Servo valve circuits
- In-Plant and mobile equipment
- Power steering circuits
- High pressure circuits

PGC: 460	Size (BSPP)	Flow Rate (lpm)	Media Rating (µm)	Media	Replacement Element	Price
K030285	1/2	50	10 Abs	Synteq®	P171732	£313.17
K030286	1/2	50	25 Abs	Synteq®	P171733	£313.17
K030288	3/4	80	10 Abs	Synteq®	P171735	£324.57
K030289	3/4	80	25 Abs	Synteq®	P171736	£324.57
K030294	1	120	10 Abs	Synteq®	P171738	£391.14
K030295	1	120	25 Abs	Synteq®	P171739	£391.14
K250068	1 1/2	280	10 Abs	Synteq®	P171613	£286.89
K250033	1 1/2	300	10 Nom	Cellulose	P550148	£223.80
K250070	1 1/2	340	30 Nom	Cellulose	P171616	£264.48

Return Filters

In-Tank High Flow Return Filter with Cap

10 bar



Working Pressure:
10 bar (145 psi)



- Specifications and applications as listed for the low flow return filters above
- With bolted A1 cover that secures to the reservoir top by 2 or 4 bolts

PGC: 460	Size (BSPP)	Flow Rate (lpm)	Media Rating (µm)	Media	Replacement Element	Price
K070288	1 1/2	160	10 Nom	Cellulose	P171551	£177.97
K070030	2	400	10 Nom	Cellulose	P171569	£187.98
K070292	1 1/2	140	25 Abs	Synteq®	P171556	£216.06
K070029	2	350	25 Abs	Synteq®	P171568	£242.62

In-Tank Low Flow Return Filter with Cap

10 bar



Working Pressure:
10 bar

- Return / Filler Filter
- Screw-on cover
- Ideal for low pressure in-tank applications
- Heavy duty filter with die cast aluminium head and steel canister
- Head (and inlet) sit above the tank, with the housing in the tank
- Element flow is outside to inside
- Provided with cellulose media

Applications include:

- Return Lines
- Side Loop Systems
- Fluid Conditioning Systems
- Process Systems
- Case Drains
- Cooling Circuits

PGC: 460	Size (BSPP)	Flow Rate (lpm)	Media Rating (µm)	Media	Replacement Element	Price
K030311	1/2	30	10 Nom	Cellulose	P171839	£68.57
K040767	3/4	40	10 Nom	Cellulose	P171527	£72.69
K040768	1	65	10 Nom	Cellulose	P171533	£73.44
K040769	1 1/4	120	10 Nom	Cellulose	P171840	£90.05
K030313	1/2	25	25 Abs	Synteq®	P171842	£68.80
K040770	3/4	35	25 Abs	Synteq®	P171526	£77.16
K040771	1	60	25 Abs	Synteq®	P171532	£74.96
K040772	1 1/4	110	25 Abs	Synteq®	P171843	£96.44

Tank Breathers

Take Apart Metal Breather

Screw-In



- Tank breather cartridge assembly with take apart element

PGC: 460	Size (BSPP)	Flow Rate (lpm)	Media Rating (µm)	Media	Replacement Element	Price
P761049	1/4	200	10 Nom	Cellulose	P172435	£10.26
P761050	3/8	200	10 Nom	Cellulose	P172435	£11.27
P761051	1/2	500	10 Nom	Cellulose	P175447	£27.43
P761052	1	1000	10 Nom	Cellulose	P761045	£26.26
P172384	1/4	200	60	Wire Mesh	P172433	£14.40
P172385	3/8	200	60	Wire Mesh	P172433	£15.62
P172386	1/2	500	60	Wire Mesh	P171783	£20.53
P172387	1	1000	60	Wire Mesh	P171784	£34.50

Spin-On Tank Breather

With Bolt Flange



- 3-hole G3/4" bolted adaptor

PGC: 460	Size (mm)	Flow Rate (lpm)	Media Rating (µm)	Media	Replacement Element	Price
P172365	41	1200	10 Nom	Cellulose	P550268	£58.00
P172366	41	1500	30 Nom	Cellulose	P171606	£60.26
P172367	41	1600	10 Nom	Cellulose	P171610	£75.69
P172368	41	1700	30 Nom	Cellulose	P171611	£76.88

Spin-On Tank Breather

With Bolt Flange



- 6-hole G1-1/4" bolted adaptor & O-ring

PGC: 460	Size (mm)	Flow Rate (lpm)	Media Rating (µm)	Media	Replacement Element	Price
P172369	73	2400	10 Nom	Cellulose	P550148	£79.22

T.R.A.P™ Breather

With Moisture Adsorption and Electronic Indication

Temperature Range:
Effective down to -40°C



- Breather with Thermally Reactive Advanced Protection (T.R.A.P.)
- Deliquescent breather — senses moisture and begins working faster and lasts longer than silica gel desiccant breathers
- Prevents moisture condensation in hydraulic tanks by lowering and stabilising the relative humidity inside the tank, decreasing the dewpoint
- T.R.A.P. media is self-regenerating
- Media efficiency 97% on solid particulate down to 3 µm
- Reversible flow through media allows moisture to exit the tank
- Electronic Filter service indicator flashes when a change out is needed
- Construction: Glass-filled ABS
- Airflow: 45 cfm maximum
- Suits both mobile and industrial applications
- Functions in any orientation
- Low sensitivity to oil mist
- Functions well in environments with high ambient humidity

PGC: 460	Size (BSP)	Media Rating (µm)	Price
P564669	1	3 Abs	£70.84

Suction Strainers & Filters

Suction Filter with Take Apart Element 30 bar



Working Pressure:
30 bar (435 psi)

PGC: 460	Size (BSPP)	Flow Rate (lpm)	Media Rating (µm)	Media	Replacement Element	Price
K030364	1/2	20	60	Wire mesh	P171523	£109.03
K030269	3/4	30	30 Nom	Cellulose	P171534	£91.41
K030360	3/4	40	60	Wire Mesh	P171535	£97.07
K040593	1	55	10 Nom	Cellulose	P171587	£110.90
K040935	1	55	30 Nom	Cellulose	P171588	£112.04
K040936	1	65	60	Wire Mesh	P171589	£123.21
K040941	1 1/4	90	60	Wire Mesh	P171541	£153.51
K070170	1 1/2	170	60	Wire Mesh	P171565	£259.40
K070410	2	250	60	Wire Mesh	P171571	£282.45

In-Line Suction Filter with Dual Spin-On Element 10 bar



Working Pressure:
10 bar (145 psi)

- In-line spin-on style return and suction filter
- Contains Synteq® media

PGC: 460	Size (BSPP)	Flow Rate (lpm)	Media Rating (µm)	Media	Replacement Element	Price
K250107	1 1/2	150	10 Abs	Synteq®	P171613	£300.35
K250113	1 1/2	160	10 Abs	Synteq®	P171618	£336.25
K250108	1 1/2	150	25 Abs	Synteq®	P171614	£300.35
K250114	1 1/2	160	25 Abs	Synteq®	P171619	£340.69

In-Line Suction Filter with Spin-On Element 10 bar



Working Pressure:
10 bar (145 psi)

- In-line spin-on style return and suction filter
- Contains Synteq® media

PGC: 460	Size (BSPP)	Flow Rate (lpm)	Media Rating (µm)	Media	Replacement Element	Price
K041145	3/4	20	10 Abs	Synteq®	P171608	£87.36
K041146	3/4	20	25 Abs	Synteq®	P171609	£87.36
K051261	1 1/4	80	10 Abs	Synteq®	P171618	£157.23
K051157	1 1/4	80	25 Abs	Synteq®	P171619	£157.59

Suction Strainer with Metal End Cap



Mesh



Cellulose

- In-line threaded style suction strainer
- Zinc-plated
- Stainless steel pleated mesh screens
- Rugged steel core centre
- Epoxy-bonded to heavy gauge connector and end caps
- Cleanable and re-usable

PGC: 460	Size (BSPP)	Flow Rate (lpm)	Media Rating (µm)	Media	Price
P171861	3/8	10	90	Wire Mesh	£15.57
P171862	3/8	5	30 Nom	Cellulose	£11.31
P171863	3/8	10	60	Wire Mesh	£25.07
P171865	1/2	17	90	Wire Mesh	£19.53
P171866	1/2	9	30 Nom	Cellulose	£14.26
P171867	1/2	17	60	Wire Mesh	£23.83
P171869	3/4	25	90	Wire Mesh	£20.48
P171870	3/4	13	30 Nom	Cellulose	£16.08
P171871	3/4	25	60	Wire Mesh	£30.59
P171877	1	45	90	Wire Mesh	£23.48
P171878	1	25	30 Nom	Cellulose	£21.40
P171879	1	45	60	Wire Mesh	£35.62
P177420	1	50	250	Wire Mesh	£32.48
P171886	1 1/4	35	30 Nom	Cellulose	£28.74
P171887	1 1/4	65	60	Wire Mesh	£50.60
P171885	1 1/4	65	90	Wire Mesh	£73.72
P760321	1 1/4	90	250	Wire Mesh	£34.78
P172453	1 1/2	50	30 Nom	Cellulose	£31.34
P172454	1 1/2	90	60	Wire Mesh	£50.60
P172452	1 1/2	90	90	Wire Mesh	£45.96
P171902	2	120	30	Cellulose	£89.73
P171903	2	250	60	Wire Mesh	£126.55
P171901	2	250	90	Wire Mesh	£105.87
P171907	2 1/2	300	60	Wire Mesh	£140.46
P171905	2 1/2	300	90	Wire Mesh	£122.04
P171911	3	400	60	Wire Mesh	£160.51
P171909	3	400	90	Wire Mesh	£90.05

Fluid Level & Temperature Gauges

02

Use to facilitate accurate monitoring of the oil level in tanks and reservoirs. Fluid level and temperature gauges indicate oil level and temperature, +30°C to +90°C. Fluid level gauges indicate oil level only.

Fluid Level & Temperature Gauge Metric Connection

Maximum Working Pressure:
1 bar (14.5 psi / 100 kPa)
for pressurised tanks



- Fluid level gauge with built-in thermometer
- Temperature Scale: 0°C to +100°C
- Suggested Mounting Hole Diameter: 11 mm or 13 mm
- Recommended bolt tightening torque is 10 ft-lbs / Nt-m, with inside nut for tightening directly on the tank

PGC: 460	Thread	Size (mm)	Price
P171915	M10	76	£21.84
P171916	M12	76	£22.87
P171919	M10	127	£24.04
P171920	M12	127	£24.04
P171922	M12	254	£59.82

Fluid Level Gauge Metric Connection

Maximum Working Pressure:
1 bar (14.5 psi / 100 kPa)
for pressurised tanks



- Transparent lens material is protected by metal bar with BunaN seals
- Suitable for lubricants, mineral, petroleum and water-based fluids
- 180° visibility of fluid level
- Suggested Mounting Hole Diameter: 11 mm or 13 mm
- Recommended bolt tightening torque is 10 ft-lbs / Nt-m, with inside nut for tightening directly on the tank

PGC: 460	Thread	Size (mm)	Price
P171913	M10	76	£18.57
P171914	M12	76	£25.70
P171917	M10	127	£21.40
P171918	M12	127	£21.40
P171921	M12	254	£51.86

Media - The Heart of the Filter

Choose from Donaldson Synteq® synthetic, natural fibre cellulose or wire mesh to obtain the cleanliness level you need.

Fluid to be Filtered	Recommended Media
Petroleum-based	Synteq®, Cellulose
Phosphate Ester	Synteq®
Diester	Synteq®
Water Glycol	Synteq®
Water-Oil Emulsion	Synteq®
Biodegradable Fluid	Synteq®
HWCF (high water content fluids)	Synteq®
Coarse Filtration	Wire Mesh

Synteq® Filtration Media

When an application requires higher efficiency filtration than cellulose filter media can deliver, Donaldson uses synthetic media technology. Synthetic media captures more and smaller contaminant than cellulose media. Synteq® is ideal for filtering synthetic fluids, water glycols, water / oil emulsions; HWCF (high water content fluid) and petroleum-based fluids, and is compatible with most phosphate esters. Working pressures range from 2000 psi up to 6090 psi; static pressures from 4500 psi up to 12000 psi.



Synteq® & Cellulose Photos at Same Magnification



Cellulose fibres are inconsistent in size and shape allowing more contaminants to pass through; resulting in higher restriction and lower capacity.

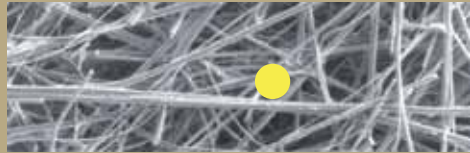

Synteq® small, consistent fibres trap smaller particles and hold more contaminants; resulting in lower restriction.

Yellow circles represent the diameter of a 20µ particle.



FLOW RATES

Abs = Absolute rating: Absolute filtration rating specifies the diameter of the largest hard, spherical particle that passes through a filter under controlled conditions. The rating is also an indication of the largest opening through the filter.

Nom = Nominal rating: Nominal filtration rating is an arbitrary value determined by the filter manufacturer. The rating system refers more to the types and sizes of holes in the filter medium than actual filter performance.

Replacement Filter Elements

Remember, if you need to replace an element manufactured by virtually anyone in the world, Donaldson produces the industry's largest selection of replacement hydraulic filters elements. Our Donaldson industry-standard 6"x18" replacement filters are suitable for large lube oil applications, including air compressors and hydraulic return lines. They can be used as a direct replacement for 6"x18" filters from Kaydon, MP Filtri, Pall, Hilco, Hydac, Baldwin, Nugent and many others. Various media choices are available including Synteq® synthetic media. Coreless hydraulic filter elements using plastic / synthetic media are also available as Pall replacements.

Set A **Speed T.R.A.P.**[™]
For Water And Dirt



New Fast-Acting Breather Eliminates Moisture From Hydraulic Reservoirs



T.R.A.P. Breather Technology from Donaldson®

- **Reacts faster** — Senses and begins removing moisture at low 15% RELATIVE HUMIDITY. This better accommodates the short cycles of hydraulic circuits
- **Lasts longer** — Exhales moisture with every flow cycle, regenerating its water-holding capacity.
- **Signals change out** — Indicates need for change out with flashing red light
- **Installs easily** — Lightweight; simply hand tighten
- **Adapts** — Suits both mobile and industrial applications

OUT-PERFORMS, OUT-LASTS

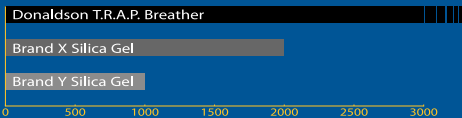

Patented T.R.A.P. media regenerates its water-holding capacity, which leads to longer service life. Competitive testing revealed that T.R.A.P. breathers continued performing beyond 3,000 cycles while silica gel breathers significantly declined in efficiency at less than 2,000 cycles.

Capture better performance today with Donaldson's new Thermally Reactive Advanced Protection (T.R.A.P) Breather.



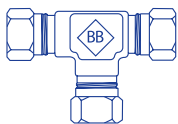

High Pressure Imperial OD Steel Compression Fittings

02

High pressure OD pipe couplings for the hydraulic, gas, automotive, chemical and nuclear industries.

Betabite OD couplings are suitable for the following working pressures, up to and including:



1" OD
1 1/4" OD
1 1/2" OD

690 bar hydraulic or 345 bar gas
552 bar hydraulic or 276 bar gas
14 bar hydraulic or 207 bar gas

Please note, these pressures are only correct if used in conjunction with the correct wall thickness of tube.

Straight Connectors

Straight Connector



PGC: 230	OD (")	Price
SC4	1/4	£8.04
SC6	3/8	£9.14
SC8	1/2	£9.14
SC10	5/8	£10.17
SC12	3/4	£11.81
SC14	7/8	£19.09
SC16	1	£24.32
SC20	1 1/4	£41.20
SC24	1 1/2	£46.23
SC32	2	£97.39

Equal Tees

Equal Tee



PGC: 230	OD (")	Price
T4	1/4	£16.06
T6	3/8	£16.06
T8	1/2	£17.43
T10	5/8	£24.58
T12	3/4	£25.89
T16	1	£47.67
T20	1 1/4	£90.87
T24	1 1/2	£128.09
T32	2	£216.80

Equal Elbows

Equal Elbow



PGC: 230	OD (")	Price
E4	1/4	£11.44
E6	3/8	£11.44
E8	1/2	£12.73
E10	5/8	£18.08
E12	3/4	£18.38
E16	1	£34.72
E20	1 1/4	£56.34
E24	1 1/2	£75.68
E32	2	£145.91

Equal Bulkheads

Equal Bulkhead



PGC: 230	OD (")	Price
BH4	1/4	£13.88
BH6	3/8	£14.09
BH8	1/2	£15.42
BH10	5/8	£21.05
BH12	3/4	£25.35
BH16	1	£60.29
BH20	1 1/4	£79.87
BH24	1 1/2	£94.47
BH32	2	£94.47

Nuts, Plugs & Ferrules

Compression Nut



PGC: 230	OD (")	Price
N4	1/4	£1.80
N6	3/8	£1.84
N8	1/2	£1.84
N10	5/8	£2.25
N12	3/4	£2.56
N16	1	£8.44
N20	1 1/4	£11.67
N24	1 1/2	£12.51
N32	2	£19.97

Compression Ferrule



PGC: 230	OD (")	Price
F4	1/4	£1.12
F6	3/8	£1.15
F8	1/2	£1.24
F10	5/8	£1.25
F12	3/4	£1.42
F16	1	£1.81
F20	1 1/4	£4.03
F24	1 1/2	£4.39
F32	2	£6.73

Blanking Plug



PGC: 230	OD (")	Price
BP4	1/4	£6.08
BP6	3/8	£5.05
BP8	1/2	£5.49
BP12	3/4	£7.09
BP16	1	£12.55
BP20	1 1/4	£14.61

Reducers

Reducing Coupling

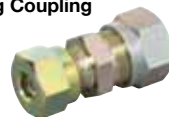

PGC: 230	OD 1 (")	OD 2 (")	Price
RC6-4	3/8	1/4	£9.32
RC8-6	1/2	3/8	£10.26
RC12-6	3/4	3/8	£20.12
RC12-8	3/4	1/2	£14.27
RC16-8	1	1/2	£23.08
RC16-12	1	3/4	£26.19

Reducing Adaptor



PGC: 230	OD (")	Stub OD (")	Price
RA4-6	1/4	3/8	£11.12
RA4-8	1/4	1/2	£11.46
RA6-8	3/8	1/2	£12.11
RA6-12	3/8	3/4	£15.04
RA8-12	1/2	3/4	£12.92
RA8-16	1/2	1	£19.55
RA12-16	3/4	1	£20.48
RA12-20	3/4	1 1/4	£30.50
RA16-20	1	1 1/4	£36.82

Male Stud Couplings

Male Stud Coupling

Male Thread BSPP



PGC: 230	OD (")	BSPP	Price
MC4-2	1/4	1/8	£5.06
MC4-4	1/4	1/4	£5.25
MC4-6	1/4	3/8	£8.66
MC4-8	1/4	1/2	£23.10
MC6-2	3/8	1/8	£10.99
MC6-4	3/8	1/4	£5.54
MC6-6	3/8	3/8	£6.19
MC6-8	3/8	1/2	£7.15
MC8-4	1/2	1/4	£6.43
MC8-6	1/2	3/8	£7.06
MC8-8	1/2	1/2	£6.86
MC8-12	1/2	3/4	£9.32
MC10-8	5/8	1/2	£10.55
MC10-12	5/8	3/4	£11.73
MC12-8	3/4	1/2	£9.19
MC12-12	3/4	3/4	£9.49
MC12-16	3/4	1	£20.34
MC12-20	3/4	1 1/4	£41.53
MC16-12	1	3/4	£14.98
MC16-16	1	1	£16.58
MC16-20	1	1 1/4	£33.56
MC20-16	1 1/4	1	£33.56
MC20-20	1 1/4	1 1/4	£33.25
MC20-24	1 1/4	1 1/2	£39.86
MC24-20	1 1/2	1 1/4	£40.92
MC24-24	1 1/2	1 1/2	£43.04

Male Stud Coupling

Male Thread BSPT



PGC: 230	OD (")	BSPT	Price
MC4-2T	1/4	1/8	£5.45
MC4-4T	1/4	1/4	£5.22
MC4-6T	1/4	3/8	£7.60
MC6-4T	3/8	1/4	£5.54
MC6-6T	3/8	3/8	£5.72
MC6-8T	3/8	1/2	£8.41
MC8-4T	1/2	1/4	£7.07
MC8-6T	1/2	3/8	£7.07
MC8-8T	1/2	1/2	£7.07
MC10-8T	5/8	1/2	£10.72
MC10-12T	5/8	3/4	£18.35
MC12-8T	3/4	1/2	£11.63
MC12-12T	3/4	3/4	£10.01
MC12-16T	3/4	1	£21.58
MC12-20T	3/4	1 1/4	£37.26
MC16-12T	1	3/4	£19.75
MC16-16T	1	1	£17.08
MC16-20T	1	1 1/4	£35.10
MC20-16T	1 1/4	1	£31.04
MC20-20T	1 1/4	1 1/4	£33.04
MC20-24T	1 1/4	1 1/2	£37.71
MC24-20T	1 1/2	1 1/4	£43.29
MC24-24T	1 1/2	1 1/2	£43.37

Male Stud Coupling

Male Thread NPT



PGC: 230	OD (")	NPT	Price
MC4-2N	1/4	1/8	£7.98
MC4-4N	1/4	1/4	£6.96
MC6-4N	3/8	1/4	£8.39
MC6-6N	3/8	3/8	£8.67
MC6-8N	3/8	1/2	£9.78
MC8-4N	1/2	1/4	£12.57
MC8-6N	1/2	3/8	£8.88
MC8-8N	1/2	1/2	£12.14
MC8-12N	1/2	3/4	£12.44
MC10-8N	5/8	1/2	£22.44
MC12-8N	3/4	1/2	£25.48
MC12-12N	3/4	3/4	£15.24
MC16-12N	1	3/4	£24.20
MC16-16N	1	1	£30.02
MC20-16N	1 1/4	1	£31.86
MC24-20N	1 1/2	1 1/4	£55.85

Female Stud Couplings

Female Stud Coupling

Female Thread BSPP



PGC: 230	OD (")	BSPP	Price
FC4-2	1/4	1/8	£7.43
FC4-4	1/4	1/4	£7.29
FC4-6	1/4	3/8	£10.97
FC6-4	3/8	1/4	£7.64
FC6-6	3/8	3/8	£9.97
FC6-8	3/8	1/2	£9.91
FC8-4	1/2	1/4	£8.85
FC8-6	1/2	3/8	£8.80
FC8-8	1/2	1/2	£11.01
FC12-8	3/4	1/2	£21.10
FC16-16	1	1	£20.83
FC20-20	1 1/4	1 1/4	£37.69
FC24-24	1 1/2	1 1/2	£51.30

Male Stud Elbows

Male Stud Elbow

Male Thread BSPT



PGC: 230	OD (")	BSPT	Price
ME4-4T	1/4	1/4	£13.95
ME6-4T	3/8	1/4	£12.88
ME6-6T	3/8	3/8	£13.91
ME8-6T	1/2	3/8	£17.49
ME8-8T	1/2	1/2	£17.12
ME12-12T	3/4	3/4	£34.64
ME16-16T	1	1	£43.29

Male Stud Elbow

Male Thread BSPP



PGC: 230	OD (")	BSPP	Price
ME4-2	1/4	1/8	£13.05
ME4-4	1/4	1/4	£11.63
ME6-4	3/8	1/4	£13.48
ME6-6	3/8	3/8	£13.48
ME8-4	1/2	1/4	£32.58
ME8-6	1/2	3/8	£12.74
ME8-8	1/2	1/2	£13.28
ME10-8	5/8	1/2	£20.38
ME12-8	3/4	1/2	£27.61
ME12-12	3/4	3/4	£34.64
ME16-16	1	1	£43.64
ME20-20	1 1/4	1 1/4	£223.67
ME24-24	1 1/2	1 1/2	£107.39

Banjo Couplings

Banjo Coupling

Male Thread BSPP



PGC: 230	OD (")	BSPP	Price
BJ4-2	1/4	1/8	£20.47
BJ4-4	1/4	1/4	£22.91
BJ6-4	3/8	1/4	£21.56
BJ6-6	3/8	3/8	£24.88
BJ8-6	1/2	3/8	£29.73
BJ8-8	1/2	1/2	£35.86
BJ12-8	3/4	1/2	£54.16
BJ12-12	3/4	3/4	£61.77
BJ16-12	1	3/4	£97.41
BJ16-16	1	1	£166.48
BJ20-16	1 1/4	1	£229.66
BJ20-20	1 1/4	1 1/4	£177.79
BJ24-20	1 1/2	1 1/4	£189.12
BJ32-24	2	1 1/2	£214.59

Standpipe Adaptors

Male Standpipe Adaptor

Male Thread BSPP

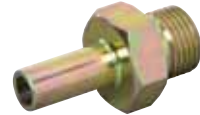

PGC: 230	OD (")	BSPP	Price
SA4-4	1/4	1/4	£7.06
SA4-6	3/8	1/4	£4.45
SA4-8	1/2	1/4	£6.25
SA6-4	1/4	3/8	£6.90
SA6-6	3/8	3/8	£4.96
SA6-8	1/2	3/8	£4.96
SAB-8	1/2	1/2	£7.79
SAB-12	3/4	1/2	£7.98
SA12-12	3/4	3/4	£10.79
SA12-16	1	3/4	£11.33
SA16-16	1	1	£15.16
SA20-20	1 1/4	1 1/4	£25.46
SA24-24	1 1/2	1 1/2	£36.30

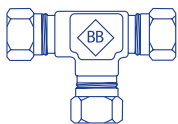

High Pressure Imperial NB Steel Compression Fittings

02

High pressure NB pipe couplings for the hydraulic, gas, automotive, chemical and nuclear industries.

Betabite NB couplings are suitable for the following working pressures, up to and including:



3/4" NB
1" NB
1 1/4" NB
1 1/2" NB

690 bar hydraulic or 345 bar gas
552 bar hydraulic or 276 bar gas
414 bar hydraulic or 207 bar gas
207 bar hydraulic or 173 bar gas

Please note, these pressures are only correct if used in conjunction with the correct wall thickness of tube.

Straight Connectors

Straight Connector



PGC: 230	NB (")	Price
NSC2-2	1/8	£14.34
NSC4-4	1/4	£11.86
NSC6-6	3/8	£12.40
NSC8-8	1/2	£16.23
NSC12-12	3/4	£28.37
NSC16-16	1	£32.68
NSC20-20	1 1/4	£69.83
NSC24-24	1 1/2	£99.99

Equal Tees

Equal Tee



PGC: 230	NB (")	Price
NT2-2-2	1/8	£50.49
NT4-4-4	1/4	£24.71
NT6-6-6	3/8	£30.15
NT8-8-8	1/2	£39.12
NT12-12-12	3/4	£70.21
NT16-16-16	1	£90.18
NT20-20-20	1 1/4	£177.30
NT24-24-24	1 1/2	£197.63

Equal Elbows

Equal Elbow



PGC: 230	NB (")	Price
NE2-2	1/8	£74.47
NE4-4	1/4	£21.76
NE6-6	3/8	£21.48
NE8-8	1/2	£23.79
NE12-12	3/4	£50.59
NE16-16	1	£58.59
NE20-20	1 1/4	£129.95
NE24-24	1 1/2	£135.46

Equal Bulkheads

Equal Bulkhead



PGC: 230	NB (")	Price
NBH2-2	1/8	£27.06
NBH4-4	1/4	£24.00
NBH6-6	3/8	£27.04
NBH8-8	1/2	£39.83
NBH12-12	3/4	£65.66
NBH16-16	1	£73.94
NBH20-20	1 1/4	£131.36
NBH24-24	1 1/2	£123.73

Nuts, Plugs & Ferrules

Compression Nut



PGC: 230	NB (")	Price
NN2	1/8	£2.65
NN4	1/4	£2.65
NN6	3/8	£2.79
NN8	1/2	£3.63
NN12	3/4	£8.38
NN16	1	£11.12
NN20	1 1/4	£16.72
NN24	1 1/2	£23.24

Compression Ferrule



PGC: 230	NB (")	Price
NF2	1/8	£1.32
NF4	1/4	£1.32
NF6	3/8	£1.55
NF8	1/2	£1.71
NF12	3/4	£2.79
NF16	1	£2.82
NF20	1 1/4	£5.55
NF24	1 1/2	£7.15

Blanking Plug



PGC: 230	NB (")	Price
NBP2	1/8	£7.92
NBP4	1/4	£8.39
NBP6	3/8	£8.67
NBP8	1/2	£18.73
NBP12	3/4	£25.46
NBP16	1	£42.01
NBP20	1 1/4	£55.89
NBP24	1 1/2	£55.89

Reducers

Reducing Coupling



PGC: 230	NB 1 (")	NB 2 (")	Price
NRC6-4	3/8	1/4	£20.89
NRC8-6	1/2	3/8	£32.18
NRC12-8	3/4	1/2	£36.66
NRC16-8	1	1/2	£44.82
NRC16-12	1	3/4	£32.47

Reducing Adaptor



PGC: 230	Stub NB (")	NB (")	Price
NRA2-4	1/4	1/8	£18.38
NRA4-6	3/8	1/4	£18.38
NRA4-8	1/2	1/4	£18.38
NRA6-8	1/2	3/8	£22.23
NRA8-12	3/4	1/2	£28.68
NRA12-16	1	3/4	£35.40

Male Stud Couplings

Male Stud Coupling

Male Thread BSPT



PGC: 230	NB (")	BSPT	Price
NMC2-4T	1/8	1/4	£29.98
NMC4-2T	1/4	1/8	£21.97
NMC4-4T	1/4	1/4	£8.59
NMC4-6T	1/4	3/8	£10.32
NMC4-8T	1/4	1/2	£12.75
NMC6-4T	3/8	1/4	£17.23
NMC6-6T	3/8	3/8	£14.70
NMC6-8T	3/8	1/2	£15.99
NMC8-6T	1/2	3/8	£20.14
NMC8-8T	1/2	1/2	£11.21
NMC8-12T	1/2	3/4	£20.14
NMC12-8T	3/4	1/2	£31.12
NMC12-12T	3/4	3/4	£56.59
NMC12-16T	3/4	1	£56.59
NMC16-12T	1	3/4	£43.81
NMC16-16T	1	1	£77.49
NMC16-20T	1	1 1/4	£34.67
NMC20-16T	1 1/4	1	£32.86
NMC20-20T	1 1/4	1 1/4	£54.04
NMC24-24T	1 1/2	1 1/2	£67.85

Male Stud Coupling

Male Thread BSPP



PGC: 230	NB (")	BSPP	Price
NMC2-2	1/8	1/8	£8.42
NMC2-4	1/8	1/4	£11.23
NMC2-6	1/8	3/8	£8.28
NMC4-2	1/4	1/8	£8.75
NMC4-4	1/4	1/4	£7.64
NMC4-6	1/4	3/8	£7.94
NMC4-8	1/4	1/2	£12.50
NMC6-4	3/8	1/4	£13.41
NMC6-6	3/8	3/8	£9.23
NMC6-8	3/8	1/2	£9.23
NMC6-12	3/8	3/4	£13.11
NMC8-4	1/2	1/4	£12.88
NMC8-6	1/2	3/8	£10.97
NMC8-8	1/2	1/2	£10.75
NMC8-12	1/2	3/4	£13.78
NMC8-16	1/2	1	£28.92
NMC12-6	3/4	3/8	£21.67
NMC12-8	3/4	1/2	£19.22
NMC12-12	3/4	3/4	£18.45
NMC16-12	1	3/4	£27.03
NMC16-16	1	1	£25.80
NMC16-20	1	1 1/4	£35.86
NMC20-16	1 1/4	1	£46.23
NMC20-20	1 1/4	1 1/4	£49.02

Male Stud Coupling

Male Thread NPT



PGC: 230	NB (")	NPT	Price
NMC2-2N	1/8	1/8	£17.47
NMC2-4N	1/8	1/4	£11.44
NMC4-4N	1/4	1/4	£11.58
NMC4-6N	1/4	3/8	£20.91
NMC6-6N	3/8	3/8	£25.25
NMC6-8N	3/8	1/2	£35.89
NMC8-4N	1/2	1/4	£15.98
NMC8-6N	1/2	3/8	£30.05
NMC8-8N	1/2	1/2	£13.33
NMC8-12N	1/2	3/4	£24.52
NMC12-12N	3/4	3/4	£71.56
NMC16-16N	1	1	£58.50

Female Stud Couplings

Female Stud Coupling

Female Thread BSPP



PGC: 230	NB (")	BSPP	Price
NFC2-2	1/8	1/8	£9.49
NFC4-4	1/4	1/4	£9.08
NFC4-6	1/4	3/8	£9.28
NFC4-8	1/4	1/2	£15.42
NFC6-6	3/8	3/8	£10.59
NFC6-8	3/8	1/2	£12.74
NFC8-8	1/2	1/2	£12.74
NFC12-12	3/4	3/4	£22.16
NFC16-16	1	1	£27.26
NFC20-20	1 1/4	1 1/4	£54.83
NFC24-24	1 1/2	1 1/2	£54.83

Male Stud Elbows

Male Stud Elbow

Male Thread BSPT



PGC: 230	NB (")	BSPT	Price
NME4-4T	1/4	1/4	£18.32
NME6-6T	3/8	3/8	£24.43
NME8-8T	1/2	1/2	£25.49
NME12-12T	3/4	3/4	£56.59
NME16-16T	1	1	£77.49

Male Stud Elbow

Male Thread BSPP



PGC: 230	NB (")	BSPP	Price
NME2-4	1/8	1/4	£21.53
NME4-4	1/4	1/4	£20.96
NME6-6	3/8	3/8	£22.79
NME6-8	3/8	1/2	£21.55
NME8-8	1/2	1/2	£31.37
NME12-12	3/4	3/4	£31.37
NME16-16	1	1	£77.49

Banjo Couplings

Banjo Coupling

Male Thread BSPP



PGC: 230	NB (")	BSPP	Price
NBJ2-2	1/8	1/8	£25.07
NBJ2-4	1/8	1/4	£25.79
NBJ4-4	1/4	1/4	£27.95
NBJ6-4	3/8	1/4	£56.67
NBJ6-6	3/8	3/8	£49.63
NBJ6-8	3/8	1/2	£50.20
NBJ8-8	1/2	1/2	£47.83
NBJ8-12	1/2	3/4	£78.66
NBJ12-12	3/4	3/4	£107.23
NBJ16-16	1	1	£138.21
NBJ20-20	1 1/4	1 1/4	£215.79
NBJ24-24	1 1/2	1 1/2	£287.24

Standpipe Adaptors

Male Standpipe Adaptor

Male Thread BSPP

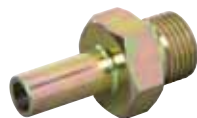

PGC: 230	NB (")	BSPP	Price
NSA4-4	1/4	1/4	£7.06
NSA6-4	1/4	3/8	£8.96
NSA6-6	3/8	3/8	£7.26
NSA8-6	3/8	1/2	£9.94
NSA6-8	1/2	3/8	£11.86
NSA8-8	1/2	1/2	£9.94
NSA12-12	3/4	3/4	£12.37
NSA12-16	1	3/4	£16.45
NSA16-16	1	1	£17.48
NSA20-20	1 1/4	1 1/4	£22.80
NSA24-24	1 1/2	1 1/2	£134.76



Steel Tube

Available in 3 and 6 metre lengths.

3 Metre Seamless Imperial Steel Tube

Imperial OD Steel Tube 3 Metre Length



- Manufactured to BS 3602
- Seamless
- Phosphate finish

PGC: 214	OD (")	Gauge	Working Pressure (bar)	Price
HT4-16-3	1/4	16	615	£29.51
HT6-16-3	3/8	16	410	£32.85
HT8-16-3	1/2	16	308	£43.95
HT10-12-3	5/8	12	398	£73.83
HT12-12-3	3/4	12	332	£59.89
HT16-14-3	1	14	191	£116.05
HT20-12-3	1 1/4	12	199	£126.18
HT24-10-3	1 1/2	10	204	£171.48

Imperial NB Steel Tube 3 Metre Length



- Manufactured to BS 3602
- Seamless
- Phosphate finish

PGC: 214	NB (")	Gauge	Working Pressure (bar)	Price
NHT4-12-3	1/4	12	469	£65.04
NHT6-11-3	3/8	11	405	£73.60
NHT8-10-3	1/2	10	363	£88.05
NHT12-9-3	3/4	9	325	£110.65
NHT16-8-3	1	8	285	£194.43
NHT20-7-3	1 1/4	7	273	£243.62
NHT24-6-3	1 1/2	6	201	£284.10

3 Metre Metric Steel Tube

Metric Steel Tube 3 Metre Length

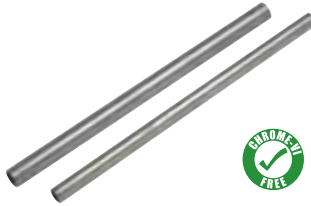

- Manufactured to DIN 2391 part c
- Material: ST37.4
- Chrome VI-Free plated

PGC: 212	OD (mm)	Wall (mm)	Working Pressure (bar)	Price
MHT4-1-3P	4	1	600	£17.67
MHT6-1-3P	6	1	400	£18.48
MHT6-1.5-3P	6	1.5	600	£21.20
MHT8-1-3P	8	1	300	£23.98
MHT8-1.5-3P	8	1.5	450	£26.99
MHT10-1-3P	10	1	240	£23.96
MHT10-1.5-3P	10	1.5	360	£26.47
MHT10-2-3P	10	2	480	£31.04
MHT12-1-3P	12	1	200	£27.45
MHT12-1.5-3P	12	1.5	300	£32.18
MHT12-2-3P	12	2	400	£36.87
MHT14-2-3P	14	2	342	£38.10
MHT15-1.5-3P	15	1.5	240	£36.58
MHT15-2-3P	15	2	320	£44.50
MHT16-1.5-3P	16	1.5	225	£42.44
MHT16-2-3P	16	2	300	£52.57
MHT16-2.5-3P	16	2.5	375	£58.32
MHT16-3-3P	16	3	450	£66.29
MHT18-1.5-3P	18	1.5	200	£58.85
MHT18-2-3P	18	2	266	£60.92
MHT18-2.5-3P	18	2.5	333	£67.94
MHT20-1.5-3P	20	1.5	180	£54.42
MHT20-2-3P	20	2	191	£61.79
MHT20-2.5-3P	20	2.5	300	£63.55
MHT20-3-3P	20	3	360	£67.34
MHT22-1.5-3P	22	1.5	163	£58.38
MHT22-2-3P	22	2	218	£60.86
MHT22-2.5-3P	22	2.5	272	£67.45
MHT25-2-3P	25	2	192	£71.51
MHT25-2.5-3P	25	2.5	240	£82.62
MHT25-3-3P	25	3	288	£91.90
MHT25-4-3P	25	4	384	£123.45
MHT28-2-3P	28	2	171	£76.47
MHT28-2.5-3P	28	2.5	214	£81.12
MHT28-3-3P	28	3	257	£101.21
MHT30-2.5-3P	30	2.5	200	£91.31
MHT30-3-3P	30	3	240	£127.21
MHT30-4-3P	30	4	320	£156.41
MHT30-5-3P	30	5	400	£179.33
MHT35-2-3P	35	2	137	£109.30
MHT35-3-3P	35	3	205	£146.64
MHT38-3-3P	38	3	189	£136.48
MHT38-4-3P	38	4	252	£188.87
MHT42-2-3P	42	2	114	£186.78
MHT42-3-3P	42	3	171	£179.81

Metric Steel Tube

3 Metre Length



- Manufactured to DIN 2391 part c
- Material: ST37.4
- Phosphate finish

PGC: 212	OD (mm)	Wall (mm)	Working Pressure (bar)	Price
MHT4-1-3	4	1	600	£14.25
MHT6-1-3	6	1	400	£12.24
MHT6-1.5-3	6	1.5	600	£13.39
MHT6-2-3	6	2	800	£20.41
MHT8-1-3	8	1	300	£13.70
MHT8-1.5-3	8	1.5	450	£20.98
MHT8-2-3	8	2	600	£24.14
MHT10-1-3	10	1	240	£16.01
MHT10-1.5-3	10	1.5	360	£18.88
MHT10-2-3	10	2	480	£27.49
MHT12-1-3	12	1	200	£20.88
MHT12-1.5-3	12	1.5	300	£26.81
MHT12-2-3	12	2	400	£33.44
MHT12-2.5-3	12	2.5	500	£36.62
MHT14-1.5-3	14	1.5	256	£21.79
MHT14-2-3	14	2	342	£27.01
MHT15-1.5-3	15	1.5	240	£30.51
MHT15-2-3	15	2	320	£35.61
MHT16-1.5-3	16	1.5	225	£33.17
MHT16-2-3	16	2	300	£52.57
MHT16-2.5-3	16	2.5	375	£54.43
MHT16-3-3	16	3	450	£60.04
MHT18-1.5-3	18	1.5	200	£32.83
MHT18-2-3	18	2	266	£37.93
MHT18-2.5-3	18	2.5	333	£40.57
MHT20-1.5-3	20	1.5	180	£46.47
MHT20-2-3	20	2	191	£32.26
MHT20-2.5-3	20	2.5	300	£35.55
MHT20-3-3	20	3	360	£41.52
MHT20-4-3	20	4	480	£87.81
MHT22-1.5-3	22	1.5	163	£32.25
MHT22-2-3	22	2	218	£51.84
MHT22-2.5-3	22	2.5	272	£54.67
MHT22-3-3	22	3	327	£63.26
MHT25-2-3	25	2	192	£58.48
MHT25-2.5-3	25	2.5	240	£59.86
MHT25-3-3	25	3	288	£77.21
MHT25-4-3	25	4	384	£104.93
MHT28-2-3	28	2	171	£59.38
MHT28-2.5-3	28	2.5	214	£65.79
MHT28-3-3	28	3	257	£82.22
MHT30-2.5-3	30	2.5	200	£72.53
MHT30-3-3	30	3	240	£75.24
MHT30-4-3	30	4	320	£130.40
MHT30-5-3	30	5	400	£152.14
MHT35-2-3	35	2	137	£53.86
MHT35-2.5-3	35	2.5	171	£105.91
MHT35-3-3	35	3	205	£124.59
MHT38-3-3	38	3	189	£115.96
MHT38-4-3	38	4	252	£160.52
MHT38-5-3	38	5	315	£180.83
MHT38-6-3	38	6	378	£207.70
MHT42-2-3	42	2	114	£158.69
MHT42-3-3	42	3	171	£141.60
MHT42-4-3	42	4	228	£161.52

6 Metre Seamless Imperial Steel Tube

Imperial OD Steel Tube 6 Metre Length



- Manufactured to BS 3602
- Seamless
- Phosphate finish

PGC: 214	OD (")	Gauge	Working Pressure (bar)	Price
HT4-16-6	1/4	16	615	£57.59
HT6-16-6	3/8	16	410	£62.48
HT8-16-6	1/2	16	308	£85.75
HT10-12-6	5/8	12	398	£144.04
HT12-12-6	3/4	12	332	£116.84
HT16-14-6	1	14	191	£225.33
HT20-12-6	1 1/4	12	199	£252.37
HT24-10-6	1 1/2	10	204	£334.60

Imperial NB Steel Tube 6 Metre Length



- Manufactured to BS 3602
- Seamless
- Phosphate finish

PGC: 214	NB (")	Gauge	Working Pressure (bar)	Price
NHT4-12-6	1/4	12	469	£126.28
NHT6-11-6	3/8	11	405	£142.90
NHT8-10-6	1/2	10	363	£170.99
NHT12-9-6	3/4	9	325	£214.87
NHT16-8-6	1	8	285	£377.53
NHT20-7-6	1 1/4	7	273	£473.04
NHT24-6-6	1 1/2	6	201	£551.66

WARNING

The pressure ratings given here are for guidance purposes only. Your design pressures should include a suitable allowance over the working pressure to allow for possible fluctuations of pressure during operation.

6 Metre Metric Steel Tube

Metric Steel Tube 6 Metre Length



- Manufactured to DIN 2391 part c
- Material: ST37.4
- Chrome VI-Free plated

PGC: 212	OD (mm)	Wall (mm)	Working Pressure (bar)	Price
MHT4-1-6P	4	1	600	£34.46
MHT6-1-6P	6	1	400	£36.05
MHT6-1.5-6P	6	1.5	600	£41.34
MHT8-1-6P	8	1	300	£46.79
MHT8-1.5-6P	8	1.5	450	£52.68
MHT10-1-6P	10	1	240	£51.21
MHT10-1.5-6P	10	1.5	360	£51.63
MHT10-2-6P	10	2	480	£60.57
MHT12-1-6P	12	1	200	£53.54
MHT12-1.5-6P	12	1.5	300	£62.78
MHT12-2-6P	12	2	400	£71.96
MHT14-2-6P	14	2	342	£74.33
MHT15-1.5-6P	15	1.5	240	£71.37
MHT15-2-6P	15	2	320	£86.84
MHT16-1.5-6P	16	1.5	225	£82.78
MHT16-2-6P	16	2	300	£102.58
MHT16-2.5-6P	16	2.5	375	£113.80
MHT16-3-6P	16	3	450	£129.35
MHT18-1.5-6P	18	1.5	200	£114.83
MHT18-2-6P	18	2	266	£118.87
MHT18-2.5-6P	18	2.5	333	£132.57
MHT20-1.5-6P	20	1.5	180	£106.19
MHT20-2-6P	20	2	191	£120.58
MHT20-2.5-6P	20	2.5	300	£124.03
MHT20-3-6P	20	3	360	£131.41
MHT22-1.5-6P	22	1.5	163	£113.90
MHT22-2-6P	22	2	218	£118.74
MHT22-2.5-6P	22	2.5	272	£129.52
MHT25-2-6P	25	2	192	£139.32
MHT25-2.5-6P	25	2.5	240	£161.19
MHT25-3-6P	25	3	288	£179.30
MHT25-4-6P	25	4	384	£240.87
MHT28-2-6P	28	2	171	£149.18
MHT28-2.5-6P	28	2.5	214	£158.28
MHT28-3-6P	28	3	257	£197.49
MHT30-2.5-6P	30	2.5	200	£178.17
MHT30-3-6P	30	3	240	£248.19
MHT30-4-6P	30	4	320	£305.17
MHT30-5-6P	30	5	400	£349.89
MHT35-2-6P	35	2	137	£213.24
MHT35-3-6P	35	3	205	£286.11
MHT38-3-6P	38	3	189	£266.28
MHT38-4-6P	38	4	252	£368.53
MHT42-2-6P	42	2	114	£364.45
MHT42-3-6P	42	3	171	£350.84

Metric Steel Tube 6 Metre Length



- Manufactured to DIN 2391 part c
- Material: ST37.4
- Phosphate finish

PGC: 212	OD (mm)	Wall (mm)	Working Pressure (bar)	Price
MHT4-1-6	4	1	600	£27.81
MHT6-1-6	6	1	400	£23.89
MHT6-1.5-6	6	1.5	600	£26.12
MHT6-2-6	6	2	800	£39.84
MHT8-1-6	8	1	300	£26.72
MHT8-1.5-6	8	1.5	450	£40.91
MHT8-2-6	8	2	600	£47.09
MHT10-1-6	10	1	240	£31.23
MHT10-1.5-6	10	1.5	360	£36.80
MHT10-2-6	10	2	480	£53.63
MHT12-1-6	12	1	200	£40.76
MHT12-1.5-6	12	1.5	300	£52.31
MHT12-2-6	12	2	400	£65.25
MHT12-2.5-6	12	2.5	500	£71.46
MHT14-1.5-6	14	1.5	256	£42.50
MHT14-2-6	14	2	342	£52.71
MHT15-1.5-6	15	1.5	240	£60.99
MHT15-2-6	15	2	320	£69.48
MHT16-1.5-6	16	1.5	225	£64.72
MHT16-2-6	16	2	300	£102.57
MHT16-2.5-6	16	2.5	375	£106.19
MHT16-3-6	16	3	450	£117.15
MHT18-1.5-6	18	1.5	200	£64.06
MHT18-2-6	18	2	266	£69.70
MHT18-2.5-6	18	2.5	333	£79.18
MHT20-1.5-6	20	1.5	180	£90.66
MHT20-2-6	20	2	191	£91.45
MHT20-2.5-6	20	2.5	300	£92.53
MHT20-3-6	20	3	360	£105.82
MHT20-4-6	20	4	480	£171.33
MHT22-1.5-6	22	1.5	163	£64.48
MHT22-2-6	22	2	218	£101.13
MHT22-2.5-6	22	2.5	272	£109.34
MHT22-3-6	22	3	327	£123.43
MHT25-2-6	25	2	192	£114.10
MHT25-2.5-6	25	2.5	240	£116.80
MHT25-3-6	25	3	288	£150.64
MHT25-4-6	25	4	384	£204.75
MHT28-2-6	28	2	171	£115.85
MHT28-2.5-6	28	2.5	214	£128.37
MHT28-3-6	28	3	257	£160.42
MHT30-2.5-6	30	2.5	200	£141.52
MHT30-3-6	30	3	240	£146.80
MHT30-4-6	30	4	320	£258.58
MHT30-5-6	30	5	400	£296.81
MHT35-2-6	35	2	137	£107.68
MHT35-2.5-6	35	2.5	171	£206.63
MHT35-3-6	35	3	205	£243.10
MHT38-3-6	38	3	189	£226.25
MHT38-4-6	38	4	252	£313.20
MHT38-5-6	38	5	315	£352.84
MHT38-6-6	38	6	378	£405.27
MHT42-2-6	42	2	114	£309.60
MHT42-3-6	42	3	171	£276.30
MHT42-4-6	42	4	228	£315.18



DIN 3015

Tube Clamps & Fastening Systems

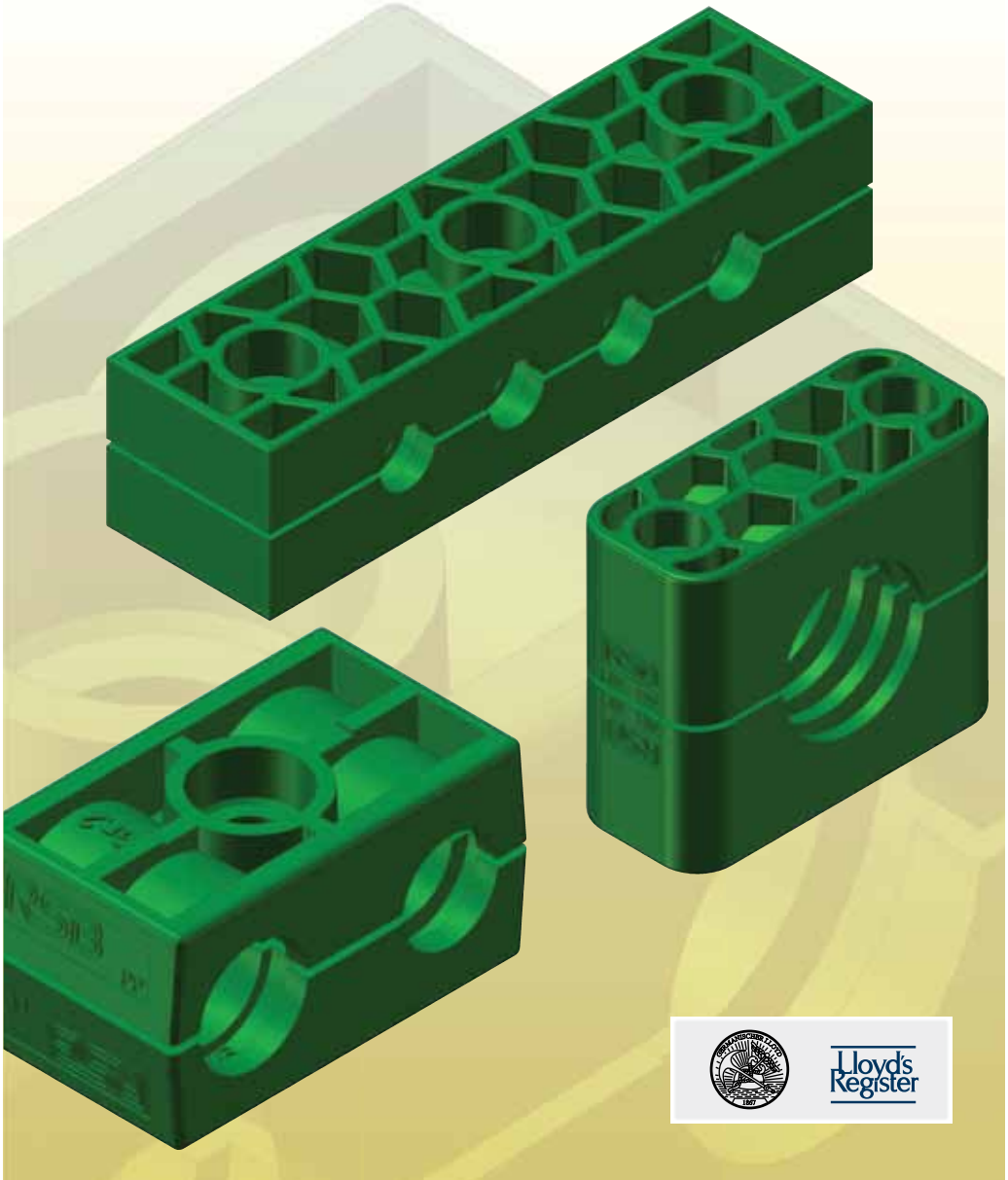

Lloyd's
Register



Single Standard Tube Clamps & Accessories

Single Standard Tube Clamp Jaws

Polypropylene



• Supplied in pairs

PGC: 224	Group	OD (mm)	Price
RAPR-004	0	4	£1.23
RAPR-006	0	6	£1.23
RAPR-006.4	0	6.4	£1.23
RAPR-008	0	8	£1.23
RAPR-009.5	0	9.5	£1.23
RAPR-010	0	10	£1.23
RAPR-012	0	12	£1.23
RAPR-104	1	4	£1.38
RAPR-106	1	6	£1.38
RAPR-106.4	1	6.4	£1.38
RAPR-108	1	8	£1.38
RAPR-109.5	1	9.5	£1.38
RAPR-110	1	10	£1.38
RAPR-112	1	12	£1.38
RAPR-212.7	2	12.7	£1.46
RAPR-213.5	2	13.5	£1.46
RAPR-214	2	14	£1.46
RAPR-215	2	15	£1.46
RAPR-216	2	16	£1.46
RAPR-217.2	2	17.2	£1.46
RAPR-218	2	18	£1.46
RAPR-319	3	19	£1.79
RAPR-320	3	20	£1.79
RAPR-321.3	3	21.3	£1.79
RAPR-322	3	22	£1.79
RAPR-323	3	23	£1.79
RAPR-325	3	25	£1.79
RAPR-325.4	3	25.4	£1.79
RAPR-426.9	4	26.9	£2.22
RAPR-428	4	28	£2.22
RAPR-430	4	30	£2.22
RAPR-532	5	32	£3.44
RAPR-533.7	5	33.7	£3.44
RAPR-535	5	35	£3.44
RAPR-538	5	38	£3.44
RAPR-540	5	40	£3.44
RAPR-542	5	42	£3.44
RAPR-644.5	6	44.5	£5.34
RAPR-645	6	45	£5.34
RAPR-648	6	48	£5.34
RAPR-650	6	50	£5.34
RAPR-650.8	6	50.8	£5.34
RAPR-652	6	52	£5.34
RAPR-654	6	54	£5.34
RAPR-655	6	55	£5.34
RAPR-657	6	57	£5.34
RAPR-757.2	7	57.2	£7.44
RAPR-760.3	7	60.3	£7.44
RAPR-763.5	7	63.5	£7.44
RAPR-770	7	70	£7.44
RAPR-773	7	73	£7.44
RAPR-776.1	7	76.1	£7.44
RAPR-888.9	8	88.9	£13.03
RAPR-8101.8	8	101.8	£13.03

Single Standard Smooth Tube Clamp Jaws

Polypropylene



• Supplied in pairs

PGC: 224	Group	OD (mm)	Price
RAPG-004	0	4	£1.93
RAPG-006	0	6	£1.93
RAPG-006.4	0	6.4	£1.93
RAPG-008	0	8	£1.93
RAPG-009.5	0	9.5	£1.93
RAPG-010	0	10	£1.93
RAPG-012	0	12	£1.93
RAPG-104	1	4	£1.93
RAPG-106	1	6	£1.93
RAPG-106.4	1	6.4	£1.93
RAPG-108	1	8	£1.93
RAPG-109.5	1	9.5	£1.93
RAPG-110	1	10	£1.93
RAPG-112	1	12	£1.93
RAPG-212.7	2	12.7	£2.05
RAPG-213.5	2	13.5	£2.05
RAPG-214	2	14	£2.05
RAPG-215	2	15	£2.05
RAPG-216	2	16	£2.05
RAPG-217.2	2	17.2	£2.05
RAPG-218	2	18	£2.05
RAPG-319	3	19	£2.52
RAPG-320	3	20	£2.52
RAPG-321.3	3	21.3	£2.52
RAPG-322	3	22	£2.52
RAPG-323	3	23	£2.52
RAPG-325	3	25	£2.52
RAPG-325.4	3	25.4	£2.52
RAPG-426.9	4	26.9	£3.08
RAPG-428	4	28	£3.08
RAPG-430	4	30	£3.08
RAPG-532	5	32	£4.78
RAPG-533.7	5	33.7	£4.78
RAPG-535	5	35	£4.78
RAPG-538	5	38	£4.78
RAPG-540	5	40	£4.78
RAPG-542	5	42	£4.78
RAPG-644.5	6	44.5	£7.48
RAPG-645	6	45	£7.48
RAPG-648	6	48	£7.48
RAPG-650	6	50	£7.48
RAPG-650.8	6	50.8	£7.48
RAPG-652	6	52	£7.48
RAPG-654	6	54	£7.48
RAPG-655	6	55	£7.48
RAPG-657	6	57	£7.48
RAPG-757.2	7	57.2	£8.94
RAPG-760.3	7	60.3	£8.94
RAPG-763.5	7	63.5	£8.94
RAPG-770	7	70	£8.94
RAPG-773	7	73	£8.94
RAPG-776.1	7	76.1	£8.94
RAPG-888.9	8	88.9	£15.63
RAPG-8101.8	8	101.8	£15.63

Single Standard Tube Clamp Jaws

Polyamide 6



• Supplied in pairs

PGC: 224	Group	OD (mm)	Price
RANR-004	0	4	£1.77
RANR-006	0	6	£1.77
RANR-006.4	0	6.4	£1.77
RANR-008	0	8	£1.77
RANR-009.5	0	9.5	£1.77
RANR-010	0	10	£1.77
RANR-012	0	12	£1.77
RANR-104	1	4	£2.22
RANR-106	1	6	£2.22
RANR-106.4	1	6.4	£2.22
RANR-108	1	8	£2.22
RANR-109.5	1	9.5	£2.22
RANR-110	1	10	£2.22
RANR-112	1	12	£2.22
RANR-212.7	2	12.7	£2.47
RANR-213.5	2	13.5	£2.47
RANR-214	2	14	£2.47
RANR-215	2	15	£2.47
RANR-216	2	16	£2.47
RANR-217.2	2	17.2	£2.47
RANR-218	2	18	£2.47
RANR-319	3	19	£2.79
RANR-320	3	20	£2.79
RANR-321.3	3	21.3	£2.79
RANR-322	3	22	£2.79
RANR-323	3	23	£2.79
RANR-325	3	25	£2.79
RANR-325.4	3	25.4	£2.79
RANR-426.9	4	26.9	£3.71
RANR-428	4	28	£3.71
RANR-430	4	30	£3.71
RANR-532	5	32	£5.72
RANR-533.7	5	33.7	£5.72
RANR-535	5	35	£5.72
RANR-538	5	38	£5.72
RANR-540	5	40	£5.72
RANR-542	5	42	£5.72
RANR-644.5	6	44.5	£10.26
RANR-645	6	45	£10.26
RANR-648	6	48	£10.26
RANR-650	6	50	£10.26
RANR-650.8	6	50.8	£10.26
RANR-652	6	52	£10.26
RANR-654	6	54	£10.26
RANR-655	6	55	£10.26
RANR-657	6	57	£10.26
RANR-757.2	7	57.2	£15.55
RANR-760.3	7	60.3	£15.55
RANR-763.5	7	63.5	£15.55
RANR-770	7	70	£15.55
RANR-773	7	73	£15.55
RANR-776.1	7	76.1	£15.55
RANR-888.9	8	88.9	£22.93
RANR-8101.8	8	101.8	£22.93

Single Standard Smooth Tube Clamp Jaws

Polyamide 6



• Supplied in pairs

PGC: 224	Group	OD (mm)	Price
RANG-004	0	4	£3.08
RANG-006	0	6	£3.08
RANG-006.4	0	6.4	£3.08
RANG-008	0	8	£3.08
RANG-009.5	0	9.5	£3.08
RANG-010	0	10	£3.08
RANG-012	0	12	£3.08
RANG-104	1	4	£3.08
RANG-106	1	6	£3.08
RANG-106.4	1	6.4	£3.08
RANG-108	1	8	£3.08
RANG-109.5	1	9.5	£3.08
RANG-110	1	10	£3.08
RANG-112	1	12	£3.08
RANG-212.7	2	12.7	£3.45
RANG-213.5	2	13.5	£3.45
RANG-214	2	14	£3.45
RANG-215	2	15	£3.45
RANG-216	2	16	£3.45
RANG-217.2	2	17.2	£3.45
RANG-218	2	18	£3.45
RANG-319	3	19	£3.90
RANG-320	3	20	£3.90
RANG-321.3	3	21.3	£3.90
RANG-322	3	22	£3.90
RANG-323	3	23	£3.90
RANG-325	3	25	£3.90
RANG-325.4	3	25.4	£3.90
RANG-426.9	4	26.9	£5.19
RANG-428	4	28	£5.19
RANG-430	4	30	£5.19
RANG-532	5	32	£8.01
RANG-533.7	5	33.7	£8.01
RANG-535	5	35	£8.01
RANG-538	5	38	£8.01
RANG-540	5	40	£8.01
RANG-542	5	42	£8.01
RANG-644.5	6	44.5	£14.35
RANG-645	6	45	£14.35
RANG-648	6	48	£14.35
RANG-650	6	50	£14.35
RANG-650.8	6	50.8	£14.35
RANG-652	6	52	£14.35
RANG-654	6	54	£14.35
RANG-655	6	55	£14.35
RANG-657	6	57	£14.35
RANG-757.2	7	57.2	£18.68
RANG-760.3	7	60.3	£18.68
RANG-763.5	7	63.5	£18.68
RANG-770	7	70	£18.68
RANG-773	7	73	£18.68
RANG-776.1	7	76.1	£18.68
RANG-888.9	8	88.9	£27.49
RANG-8101.8	8	101.8	£27.49

Single Standard Tube Clamp Jaws

TPE Rubber



• Supplied in pairs

PGC: 224	Group	OD (mm)	Price
RAVG-004	0	4	£3.26
RAVG-006	0	6	£3.26
RAVG-006.4	0	6.4	£3.26
RAVG-008	0	8	£3.26
RAVG-009.5	0	9.5	£3.26
RAVG-010	0	10	£3.26
RAVG-012	0	12	£3.26
RAVG-104	1	4	£3.26
RAVG-106	1	6	£3.26
RAVG-106.4	1	6.4	£3.26
RAVG-108	1	8	£3.26
RAVG-109.5	1	9.5	£3.26
RAVG-110	1	10	£3.26
RAVG-112	1	12	£3.26
RAVG-212.7	2	12.7	£3.76
RAVG-213.5	2	13.5	£3.76
RAVG-214	2	14	£3.76
RAVG-215	2	15	£3.76
RAVG-216	2	16	£3.76
RAVG-217.2	2	17.2	£3.76
RAVG-218	2	18	£3.76
RAVG-319	3	19	£4.58
RAVG-320	3	20	£4.58
RAVG-321.3	3	21.3	£4.58
RAVG-322	3	22	£4.58
RAVG-323	3	23	£4.58
RAVG-325	3	25	£4.58
RAVG-325.4	3	25.4	£4.58
RAVG-426.9	4	26.9	£5.76
RAVG-428	4	28	£5.76
RAVG-430	4	30	£5.76
RAVG-532	5	32	£9.78
RAVG-533.7	5	33.7	£9.78
RAVG-535	5	35	£9.78
RAVG-538	5	38	£9.78
RAVG-540	5	40	£9.78
RAVG-542	5	42	£9.78
RAVG-644.5	6	44.5	£13.92
RAVG-645	6	45	£13.92
RAVG-648	6	48	£13.92
RAVG-650	6	50	£13.92
RAVG-650.8	6	50.8	£13.92
RAVG-652	6	52	£13.92
RAVG-654	6	54	£13.92
RAVG-655	6	55	£13.92
RAVG-657	6	57	£13.92
RAVG-757.2	7	57.2	£30.62
RAVG-760.3	7	60.3	£30.62
RAVG-763.5	7	63.5	£30.62
RAVG-770	7	70	£30.62
RAVG-773	7	73	£30.62
RAVG-776.1	7	76.1	£30.62
RAVG-888.9	8	88.9	£36.01
RAVG-8101.8	8	101.8	£36.01

Single Standard Tube Clamp Jaws

Aluminium



• Supplied in pairs

PGC: 224	Group	OD (mm)	Price
RAAR-104	1	4	£5.63
RAAR-106	1	6	£5.63
RAAR-106.4	1	6.4	£5.63
RAAR-108	1	8	£5.63
RAAR-109.5	1	9.5	£5.63
RAAR-110	1	10	£5.63
RAAR-112	1	12	£5.63
RAAR-212.7	2	12.7	£7.08
RAAR-213.5	2	13.5	£7.08
RAAR-214	2	14	£7.08
RAAR-215	2	15	£7.08
RAAR-216	2	16	£7.08
RAAR-217.2	2	17.2	£7.08
RAAR-218	2	18	£7.08
RAAR-319	3	19	£7.74
RAAR-320	3	20	£7.74
RAAR-321.3	3	21.3	£7.74
RAAR-322	3	22	£7.74
RAAR-323	3	23	£7.74
RAAR-325	3	25	£7.74
RAAR-325.4	3	25.4	£7.74
RAAR-426.9	4	26.9	£8.44
RAAR-428	4	28	£8.44
RAAR-430	4	30	£8.44
RAAR-532	5	32	£11.93
RAAR-533.7	5	33.7	£11.93
RAAR-535	5	35	£11.93
RAAR-538	5	38	£11.93
RAAR-540	5	40	£11.93
RAAR-542	5	42	£11.93
RAAR-644.5	6	44.5	£23.85
RAAR-645	6	45	£23.85
RAAR-648	6	48	£23.85
RAAR-650	6	50	£23.85
RAAR-650.8	6	50.8	£23.85
RAAR-652	6	52	£23.85
RAAR-654	6	54	£23.85
RAAR-655	6	55	£23.85
RAAR-657	6	57	£23.85

Single Standard Complete Tube Clamp

Polypropylene



PGC: 224	Group	OD (mm)	Price
RAPR-3-004	0	4	£3.94
RAPR-3-006	0	6	£3.94
RAPR-3-006.4	0	6.4	£3.94
RAPR-3-008	0	8	£3.94
RAPR-3-009.5	0	9.5	£3.94
RAPR-3-010	0	10	£3.94
RAPR-3-012	0	12	£3.94
RAPR-3-104	1	4	£4.94
RAPR-3-106	1	6	£4.94
RAPR-3-106.4	1	6.4	£4.94
RAPR-3-108	1	8	£4.94
RAPR-3-109.5	1	9.5	£4.94
RAPR-3-110	1	10	£4.94
RAPR-3-112	1	12	£4.94
RAPR-3-212.7	2	12.7	£5.23
RAPR-3-213.5	2	13.5	£5.23
RAPR-3-214	2	14	£5.23
RAPR-3-215	2	15	£5.23
RAPR-3-216	2	16	£5.23
RAPR-3-217.2	2	17.2	£5.23
RAPR-3-218	2	18	£5.23
RAPR-3-319	3	19	£5.74
RAPR-3-320	3	20	£5.74
RAPR-3-321.3	3	21.3	£5.74
RAPR-3-322	3	22	£5.74
RAPR-3-323	3	23	£5.74
RAPR-3-325	3	25	£5.74
RAPR-3-325.4	3	25.4	£5.74
RAPR-3-426.9	4	26.9	£6.45
RAPR-3-428	4	28	£6.45
RAPR-3-430	4	30	£6.45
RAPR-3-532	5	32	£8.23
RAPR-3-533.7	5	33.7	£8.23
RAPR-3-535	5	35	£8.23
RAPR-3-538	5	38	£8.23
RAPR-3-540	5	40	£8.23
RAPR-3-542	5	42	£8.23
RAPR-3-644.5	6	44.5	£12.94
RAPR-3-645	6	45	£12.94
RAPR-3-648	6	48	£12.94
RAPR-3-650	6	50	£12.94
RAPR-3-650.8	6	50.8	£12.94
RAPR-3-652	6	52	£12.94
RAPR-3-654	6	54	£12.94
RAPR-3-655	6	55	£12.94
RAPR-3-657	6	57	£12.94
RAPR-3-757.2	7	57.2	£20.19
RAPR-3-760.3	7	60.3	£20.19
RAPR-3-763.5	7	63.5	£20.19
RAPR-3-770	7	70	£20.19
RAPR-3-773	7	73	£20.19
RAPR-3-776.1	7	76.1	£20.19
RAPR-3-888.9	8	88.9	£33.76
RAPR-3-004	8	101.8	£33.76

Weld Plates

Single Standard Weld Plate

Carbon Steel



PGC: 224	Group	Price
APK-A0	0	£1.63
APK-A1	1	£2.44
APK-A2	2	£2.56
APK-A3	3	£2.68
APK-A4	4	£2.89
APK-A5	5	£3.00
APK-A6	6	£5.35
APK-A7	7	£7.27
APK-A8	8	£8.06

Stainless Steel

PGC: 224	Group	Price
APK-A0-SS	0	£8.44
APK-A1-SS	1	£11.43
APK-A2-SS	2	£11.84
APK-A3-SS	3	£12.10
APK-A4-SS	4	£14.71
APK-A5-SS	5	£15.37
APK-A6-SS	6	£15.62
APK-A7-SS	7	£20.46
APK-A8-SS	8	£22.16

Single Extended Weld Plate

Carbon Steel



PGC: 224	Group	Price
APL-A0	0	£1.26
APL-A1	1	£1.94
APL-A2	2	£2.04
APL-A3	3	£2.12
APL-A4	4	£2.21
APL-A5	5	£2.28
APL-A6	6	£2.89
APL-A7	7	£4.61
APL-A8	8	£5.41

Stainless Steel

PGC: 224	Group	Price
APL-A0-SS	0	£10.59
APL-A1-SS	1	£14.25
APL-A2-SS	2	£14.50
APL-A3-SS	3	£14.91
APL-A4-SS	4	£17.64
APL-A5-SS	5	£18.36
APL-A6-SS	6	£18.89
APL-A7-SS	7	£26.47
APL-A8-SS	8	£37.90

Double Weld Plate

Carbon Steel



PGC: 224	Group	Price
APD-A0	0	£2.23
APD-A1	1	£4.24
APD-A2	2	£4.30
APD-A3	3	£4.51
APD-A4	4	£4.74
APD-A5	5	£5.07
APD-A6	6	£6.78

Stainless Steel

PGC: 224	Group	Price
APD-A0-SS	0	£15.44
APD-A1-SS	1	£15.44
APD-A2-SS	2	£15.76
APD-A3-SS	3	£18.01
APD-A4-SS	4	£22.78
APD-A5-SS	5	£24.55
APD-A6-SS	6	£33.34
APL-A8-SS	8	£37.90

Mounting Rails

Mounting Rail

Carbon Steel



PGC: 224	Depth (mm)	Length (m)	Price
MR-11	11	1	£6.56
MR-14	14	1	£6.66
MR-30	30	1	£10.71
MR-11-2	11	2	£13.10
MR-14-2	14	2	£13.32
MR-30-2	30	2	£21.40

Stainless Steel

PGC: 224	Depth (mm)	Length (m)	Price
MR-11-SS	11	1	£26.42
MR-14-SS	14	1	£38.27
MR-11-2-SS	11	2	£52.83

Single Standard Cover Plate

Carbon Steel



PGC: 224	Group	Price
DP-A0	0	£0.55
DP-A1	1	£0.60
DP-A2	2	£0.65
DP-A3	3	£0.69
DP-A4	4	£0.75
DP-A5	5	£0.93
DP-A6	6	£1.16
DP-A7	7	£3.28
DP-A8	8	£3.68

Stainless Steel

PGC: 224	Group	Price
DP-A0-SS	0	£1.79
DP-A1-SS	1	£2.27
DP-A2-SS	2	£2.63
DP-A3-SS	3	£3.09
DP-A4-SS	4	£3.58
DP-A5-SS	5	£4.02
DP-A6-SS	6	£4.84
DP-A7-SS	7	£14.07
DP-A8-SS	8	£15.91

Hexagon Head Screw

Carbon Steel



PGC: 224	Group	Price
SSL-A0	0	£1.30
SSL-A1	1	£1.30
SSL-A2	2	£1.46
SSL-A3	3	£1.56
SSL-A4	4	£1.76
SSL-A5	5	£2.37
SSL-A6	6	£2.76
SSL-A7	7	£4.31
SSL-A8	8	£5.46

Stainless Steel

PGC: 224	Group	Price
SSL-A0-SS	0	£1.30
SSL-A1-SS	1	£1.30
SSL-A2-SS	2	£1.46
SSL-A3-SS	3	£1.56
SSL-A4-SS	4	£1.76
SSL-A5-SS	5	£2.37
SSL-A6-SS	6	£2.76
SSL-A7-SS	7	£4.31
SSL-A8-SS	8	£5.46

Stacking Bolt

Carbon Steel



PGC: 224	Group	Price
AS-A0	0	£1.21
AS-A1	1	£1.21
AS-A2	2	£1.25
AS-A3	3	£1.48
AS-A4	4	£1.70
AS-A5	5	£2.17
AS-A6	6	£3.17

Stainless Steel

PGC: 224	Group	Price
AS-A0-SS	0	£8.77
AS-A1-SS	1	£8.77
AS-A2-SS	2	£8.96
AS-A3-SS	3	£9.03
AS-A4-SS	4	£9.13
AS-A5-SS	5	£9.21
AS-A6-SS	6	£9.58

Screws & Locking Bolts

Slotted Head Screw

Carbon Steel



PGC: 224	Group	Price
SL-A0	0	£0.16
SL-A1	1	£0.16
SL-A2	2	£0.18
SL-A3	3	£0.19
SL-A4	4	£0.23
SL-A5	5	£0.32
SL-A6	6	£0.37

Stainless Steel

PGC: 224	Group	Price
SL-A0-SS	0	£1.30
SL-A1-SS	1	£1.30
SL-A2-SS	2	£1.46
SL-A3-SS	3	£1.60
SL-A4-SS	4	£1.75
SL-A5-SS	5	£2.25
SL-A6-SS	6	£2.78

Socket Head Screw

Carbon Steel



PGC: 224	Group	Price
IS-A0	0	£0.30
IS-A1	1	£0.30
IS-A2	2	£0.31
IS-A3	3	£0.31
IS-A4	4	£0.34
IS-A5	5	£0.42
IS-A6	6	£0.46
IS-A7	7	£0.61

Stainless Steel

PGC: 224	Group	Price
IS-A0-SS	0	£1.40
IS-A1-SS	1	£1.40
IS-A2-SS	2	£1.56
IS-A3-SS	3	£1.72
IS-A4-SS	4	£1.93
IS-A5-SS	5	£2.60
IS-A6-SS	6	£3.15
IS-A7-SS	7	£5.83

Rail Nuts

Rail Nut



PGC: 224	Material	Price
TM-A	Steel	£0.99
TM-A-SS	Stainless Steel	£9.03

Locking Plates & Washers

Locking Plate



PGC: 224	Material	Price
SBR-A	Steel	£0.44
SBR-A-SS	Stainless Steel	£0.67

Locking Washer

For Single TPE Rubber Clamps



PGC: 224	Material	Price
US-A	Steel	£0.44

Twin Tube Clamp Jaws

Polypropylene



• Supplied in pairs

PGC: 224	Group	OD (mm)	Price
RBPR-106	1	6	£1.71
RBPR-106.4	1	6.4	£1.71
RBPR-108	1	8	£1.71
RBPR-109.5	1	9.5	£1.71
RBPR-110	1	10	£1.71
RBPR-112	1	12	£1.71
RBPR-212.7	2	12.7	£1.94
RBPR-213.5	2	13.5	£1.94
RBPR-214	2	14	£1.94
RBPR-215	2	15	£1.94
RBPR-216	2	16	£1.94
RBPR-217.2	2	17.2	£1.94
RBPR-218	2	18	£1.94
RBPR-319	3	19	£2.52
RBPR-320	3	20	£2.52
RBPR-321.3	3	21.3	£2.52
RBPR-322	3	22	£2.52
RBPR-325	3	25	£2.52
RBPR-325.4	3	25.4	£2.52
RBPR-426.9	4	26.9	£3.09
RBPR-428	4	28	£3.09
RBPR-430	4	30	£3.09
RBPR-532	5	32	£4.73
RBPR-533.7	5	33.7	£4.73
RBPR-535	5	35	£4.73
RBPR-538	5	38	£4.73
RBPR-540	5	40	£4.73
RBPR-542	5	42	£4.73

Twin Smooth Tube Clamp Jaws

Polypropylene

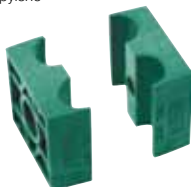

• Supplied in pairs

PGC: 224	Group	OD (mm)	Price
RBPG-106	1	6	£2.39
RBPG-106.4	1	6.4	£2.39
RBPG-108	1	8	£2.39
RBPG-109.5	1	9.5	£2.39
RBPG-110	1	10	£2.39
RBPG-112	1	12	£2.39
RBPG-212.7	2	12.7	£2.74
RBPG-213.5	2	13.5	£2.74
RBPG-214	2	14	£2.74
RBPG-215	2	15	£2.74
RBPG-216	2	16	£2.74
RBPG-217.2	2	17.2	£2.74
RBPG-218	2	18	£2.74
RBPG-319	3	19	£3.49
RBPG-320	3	20	£3.49
RBPG-321.3	3	21.3	£3.49
RBPG-322	3	22	£3.49
RBPG-325	3	25	£3.49
RBPG-325.4	3	25.4	£3.49
RBPG-426.9	4	26.9	£4.31
RBPG-428	4	28	£4.31
RBPG-430	4	30	£4.31
RBPG-532	5	32	£6.64
RBPG-533.7	5	33.7	£6.64
RBPG-535	5	35	£6.64
RBPG-538	5	38	£6.64
RBPG-540	5	40	£6.64
RBPG-542	5	42	£6.64

Twin Tube Clamp Jaws

Polyamide 6



• Supplied in pairs

PGC: 224	Group	OD (mm)	Price
RBNR-106	1	6	£2.96
RBNR-106.4	1	6.4	£2.96
RBNR-108	1	8	£2.96
RBNR-109.5	1	9.5	£2.96
RBNR-110	1	10	£2.96
RBNR-112	1	12	£2.96
RBNR-212.7	2	12.7	£3.50
RBNR-213.5	2	13.5	£3.50
RBNR-214	2	14	£3.50
RBNR-215	2	15	£3.50
RBNR-216	2	16	£3.50
RBNR-217.2	2	17.2	£3.50
RBNR-218	2	18	£3.50
RBNR-319	3	19	£4.10
RBNR-320	3	20	£4.10
RBNR-321.3	3	21.3	£4.10
RBNR-322	3	22	£4.10
RBNR-325	3	25	£4.10
RBNR-325.4	3	25.4	£4.10
RBNR-426.9	4	26.9	£5.95
RBNR-428	4	28	£5.95
RBNR-430	4	30	£5.95
RBNR-532	5	32	£8.80
RBNR-533.7	5	33.7	£8.80
RBNR-535	5	35	£8.80
RBNR-538	5	38	£8.80
RBNR-540	5	40	£8.80
RBNR-542	5	42	£8.80

Twin Smooth Tube Clamp Jaws

Polyamide 6



• Supplied in pairs

PGC: 224	Group	OD (mm)	Price
RBNG-106	1	6	£4.14
RBNG-106.4	1	6.4	£4.14
RBNG-108	1	8	£4.14
RBNG-109.5	1	9.5	£4.14
RBNG-110	1	10	£4.14
RBNG-112	1	12	£4.14
RBNG-212.7	2	12.7	£4.93
RBNG-213.5	2	13.5	£4.93
RBNG-214	2	14	£4.93
RBNG-215	2	15	£4.93
RBNG-216	2	16	£4.93
RBNG-217.2	2	17.2	£4.93
RBNG-218	2	18	£4.93
RBNG-319	3	19	£5.77
RBNG-320	3	20	£5.77
RBNG-321.3	3	21.3	£5.77
RBNG-322	3	22	£5.77
RBNG-325	3	25	£5.77
RBNG-325.4	3	25.4	£5.77
RBNG-426.9	4	26.9	£8.34
RBNG-428	4	28	£8.34
RBNG-430	4	30	£8.34
RBNG-532	5	32	£11.77
RBNG-533.7	5	33.7	£11.77
RBNG-535	5	35	£11.77
RBNG-538	5	38	£11.77
RBNG-540	5	40	£11.77
RBNG-542	5	42	£11.77

Twin Tube Clamp Jaws

TPE Rubber



• Supplied in pairs

PGC: 224	Group	OD (mm)	Price
RBVG-106	1	6	£4.92
RBVG-106.4	1	6.4	£4.92
RBVG-108	1	8	£4.92
RBVG-109.5	1	9.5	£4.92
RBVG-110	1	10	£4.92
RBVG-112	1	12	£4.92
RBVG-212.7	2	12.7	£6.55
RBVG-213.5	2	13.5	£6.55
RBVG-214	2	14	£6.55
RBVG-215	2	15	£6.55
RBVG-216	2	16	£6.55
RBVG-217.2	2	17.2	£6.55
RBVG-218	2	18	£6.55
RBVG-319	3	19	£7.78
RBVG-320	3	20	£7.78
RBVG-321.3	3	21.3	£7.78
RBVG-322	3	22	£7.78
RBVG-325	3	25	£7.78
RBVG-325.4	3	25.4	£7.78
RBVG-426.9	4	26.9	£28.28
RBVG-428	4	28	£28.28
RBVG-430	4	30	£28.28
RBVG-532	5	32	£31.40
RBVG-533.7	5	33.7	£31.40
RBVG-535	5	35	£31.40
RBVG-538	5	38	£31.40
RBVG-540	5	40	£31.40
RBVG-542	5	42	£31.40

Twin Tube Clamp Complete

Polypropylene



PGC: 224	Group	OD (mm)	Price
RBPR-1-106	1	6	£5.66
RBPR-1-106.4	1	6.4	£5.66
RBPR-1-108	1	8	£5.66
RBPR-1-109.5	1	9.5	£5.66
RBPR-1-110	1	10	£5.66
RBPR-1-112	1	12	£5.66
RBPR-1-212.7	2	12.7	£7.19
RBPR-1-213.5	2	13.5	£7.19
RBPR-1-214	2	14	£7.19
RBPR-1-215	2	15	£7.19
RBPR-1-216	2	16	£7.19
RBPR-1-217.2	2	17.2	£7.19
RBPR-1-218	2	18	£7.19
RBPR-1-319	3	19	£8.23
RBPR-1-320	3	20	£8.23
RBPR-1-321.3	3	21.3	£8.23
RBPR-1-322	3	22	£8.23
RBPR-1-325	3	25	£8.23
RBPR-1-325.4	3	25.4	£8.23
RBPR-1-426.9	4	26.9	£9.32
RBPR-1-428	4	28	£9.32
RBPR-1-430	4	30	£9.32
RBPR-1-532	5	32	£12.18
RBPR-1-533.7	5	33.7	£12.18
RBPR-1-535	5	35	£12.18
RBPR-1-538	5	38	£12.18
RBPR-1-540	5	40	£12.18
RBPR-1-542	5	42	£12.18

Weld Plates

Twin Weld Plate

Carbon Steel



PGC: 224	Group	Price
AP-B1	1	£2.78
AP-B2	2	£3.97
AP-B3	3	£4.29
AP-B4	4	£4.66
AP-B5	5	£5.56

Stainless Steel

PGC: 224	Group	Price
AP-B1-SS	1	£8.50
AP-B2-SS	2	£16.03
AP-B3-SS	3	£17.29
AP-B4-SS	4	£20.36
AP-B5-SS	5	£22.56

Twin Cover Plate

Carbon Steel



PGC: 224	Group	Price
DP-B1	1	£0.85
DP-B2	2	£0.95
DP-B3	3	£1.04
DP-B4	4	£1.15
DP-B5	5	£1.29

Stainless Steel

PGC: 224	Group	Price
DP-B1-SS	1	£2.94
DP-B2-SS	2	£3.85
DP-B3-SS	3	£4.44
DP-B4-SS	4	£5.06
DP-B5-SS	5	£6.06

Screws & Locking Bolts

Hexagon Head Screw

Carbon Steel



PGC: 224	Group	Price
SS-B1	1	£0.34
SS-B2	2	£0.35
SS-B3	3	£0.39
SS-B4	4	£0.43
SS-B5	5	£0.62

Stainless Steel

PGC: 224	Group	Price
SS-B1-SS	1	£2.64
SS-B2-SS	2	£2.64
SS-B3-SS	3	£3.14
SS-B4-SS	4	£3.37
SS-B5-SS	5	£4.20

Socket Head Screw

Carbon Steel



PGC: 224	Group	Price
IS-B1	1	£0.41
IS-B2	2	£0.41
IS-B3	3	£0.49
IS-B4	4	£0.59
IS-B5	5	£0.72

Stainless Steel

PGC: 224	Group	Price
IS-B1-SS	1	£2.57
IS-B2-SS	2	£2.57
IS-B3-SS	3	£3.43
IS-B4-SS	4	£4.01
IS-B5-SS	5	£5.46

Stacking Bolt

Carbon Steel



PGC: 224	Group	Price
AS-B1	1	£2.13
AS-B2	2	£2.13
AS-B3	3	£2.33
AS-B4	4	£3.19
AS-B5	5	£3.95

Stainless Steel

PGC: 224	Group	Price
AS-B1-SS	1	£18.89
AS-B2-SS	2	£18.89
AS-B3-SS	3	£20.95
AS-B4-SS	4	£22.97
AS-B5-SS	5	£27.99

Rail Nuts

Rail Nut

Carbon Steel



PGC: 224	Group	Price
TM-B1	1	£1.02
TM-B2	2 - 5	£2.48

Stainless Steel

PGC: 224	Group	Price
TM-B1-SS	1	£9.80
TM-B2-SS	2 - 5	£9.61

Locking Plates & Washers

Locking Plate

Carbon Steel



PGC: 224	Group	Price
SB-B1	1	£0.44
SB-B2	2 - 5	£0.42

Stainless Steel

PGC: 224	Group	Price
SB-B1-SS	1	£1.45
SB-B2-SS	2 - 5	£1.45

Locking Washer

Twin TPE Rubber Clamps



PGC: 224	Group	Price
US-B1	1	£0.74
US-B2	2 - 5	£0.74

Mounting Rails

Mounting Rail

Carbon Steel



PGC: 224	Depth (mm)	Length (m)	Price
MR-11	11	1	£6.56
MR-14	14	1	£6.66
MR-30	30	1	£10.71
MR-11-2	11	2	£13.10
MR-14-2	14	2	£13.32
MR-30-2	30	2	£21.40

Stainless Steel

PGC: 224	Depth (mm)	Length (m)	Price
MR-11-SS	11	1	£26.42
MR-14-SS	14	1	£38.27
MR-11-2-SS	11	2	£52.83

Heavy Duty Tube Clamp Jaws

Polypropylene



• Supplied in pairs

PGC: 224	Group	OD (mm)	Price
RCPR-106	1	6	£3.03
RCPR-108	1	8	£3.03
RCPR-109.5	1	9.5	£3.03
RCPR-110	1	10	£3.03
RCPR-112	1	12	£3.03
RCPR-112.7	1	12.7	£3.03
RCPR-113.5	1	13.5	£3.03
RCPR-114	1	14	£3.03
RCPR-115	1	15	£3.03
RCPR-116	1	16	£3.03
RCPR-117.2	1	17.2	£3.03
RCPR-118	1	18	£3.03
RCPR-219	2	19	£3.93
RCPR-220	2	20	£3.93
RCPR-221.3	2	21.3	£3.93
RCPR-222	2	22	£3.93
RCPR-223	2	23	£3.93
RCPR-225	2	25	£3.93
RCPR-225.4	2	25.4	£3.93
RCPR-226.9	2	26.9	£3.93
RCPR-228	2	28	£3.93
RCPR-230	2	30	£3.93
RCPR-330	3	30	£5.60
RCPR-332	3	32	£5.60
RCPR-333.7	3	33.7	£5.60
RCPR-335	3	35	£5.60
RCPR-338	3	38	£5.60
RCPR-340	3	40	£5.60
RCPR-342	3	42	£5.60
RCPR-440	4	40	£11.28
RCPR-442	4	42	£11.28
RCPR-445	4	45	£11.28
RCPR-448.3	4	48.3	£11.28
RCPR-450	4	50	£11.28
RCPR-451	4	51	£11.28
RCPR-452	4	52	£11.28
RCPR-455	4	55	£11.28
RCPR-457	4	57	£11.28
RCPR-460.3	4	60.3	£11.28
RCPR-463	4	63	£11.28
RCPR-465	4	65	£11.28
RCPR-470	4	70	£11.28
RCPR-565	5	65	£11.28
RCPR-570	5	70	£33.65
RCPR-573	5	73	£33.65
RCPR-575	5	75	£33.65
RCPR-576.1	5	76.1	£33.65
RCPR-580	5	80	£33.65
RCPR-582.5	5	82.5	£33.65
RCPR-585	5	85	£33.65
RCPR-588.9	5	88.9	£33.65
RCPR-590	5	90	£33.65
RCPR-690	6	90	£57.42

PGC: 224	Group	OD (mm)	Price
RCPR-697	6	97	£57.42
RCPR-6100	6	100	£57.42
RCPR-6101.6	6	101.6	£57.42
RCPR-6108	6	108	£57.42
RCPR-6114.3	6	114.3	£57.42
RCPR-6127	6	127	£57.42
RCPR-7127	7	127	£78.06
RCPR-7130	7	130	£78.06
RCPR-7133	7	133	£78.06
RCPR-7140	7	140	£78.06
RCPR-7150	7	150	£78.06
RCPR-7152.4	7	152.4	£78.06
RCPR-7159	7	159	£78.06
RCPR-7165.1	7	165.1	£78.06
RCPR-7168.3	7	168.3	£78.06
RCPR-8168.3	8	168.3	£159.37
RCPR-8177.8	8	177.8	£159.37
RCPR-8193.7	8	193.7	£159.37
RCPR-8203	8	203	£159.37
RCPR-8219.1	8	219.1	£159.37
RCPR-8220	8	220	£159.37
RCPR-9219.1	9	219.1	£311.95
RCPR-9244.5	9	244.5	£311.95
RCPR-9273	9	273	£311.95
RCPR-9323.9	9	323.9	£311.95
RCPR-10355.6	10	355.6	£437.79
RCPR-10406.4	10	406.4	£437.79

Heavy Duty Tube Clamp Jaws

Polyamide 6



• Supplied in pairs

PGC: 224	Group	OD (mm)	Price
RCNR-106	1	6	£5.63
RCNR-108	1	8	£5.63
RCNR-109.5	1	9.5	£5.63
RCNR-110	1	10	£5.63
RCNR-112	1	12	£5.63
RCNR-112.7	1	12.7	£5.63
RCNR-113.5	1	13.5	£5.63
RCNR-114	1	14	£5.63
RCNR-115	1	15	£5.63
RCNR-116	1	16	£5.63
RCNR-117.2	1	17.2	£5.63
RCNR-118	1	18	£5.63
RCNR-219	2	19	£7.37
RCNR-220	2	20	£7.37
RCNR-221.3	2	21.3	£7.37
RCNR-222	2	22	£7.37
RCNR-223	2	23	£7.37
RCNR-225	2	25	£7.37
RCNR-225.4	2	25.4	£7.37
RCNR-226.9	2	26.9	£7.37
RCNR-228	2	28	£7.37
RCNR-230	2	30	£7.37
RCNR-330	3	30	£11.04
RCNR-332	3	32	£11.04
RCNR-333.7	3	33.7	£11.04
RCNR-335	3	35	£11.04
RCNR-338	3	38	£11.04
RCNR-340	3	40	£11.04
RCNR-342	3	42	£11.04
RCNR-438	4	38	£24.65
RCNR-440	4	40	£24.65
RCNR-442	4	42	£24.65
RCNR-445	4	45	£24.65
RCNR-448.3	4	48.3	£24.65
RCNR-450	4	50	£24.65
RCNR-451	4	51	£24.65
RCNR-452	4	52	£24.65
RCNR-455	4	55	£24.65
RCNR-457	4	57	£24.65
RCNR-460.3	4	60.3	£24.65
RCNR-463	4	63	£24.65
RCNR-465	4	65	£24.65
RCNR-470	4	70	£24.65
RCNR-565	5	65	£60.10
RCNR-570	5	70	£60.10
RCNR-573	5	73	£60.10
RCNR-575	5	75	£60.10
RCNR-576.1	5	76.1	£60.10
RCNR-580	5	80	£60.10
RCNR-582.5	5	82.5	£60.10
RCNR-585	5	85	£60.10
RCNR-588.9	5	88.9	£60.10
RCNR-590	5	90	£60.10

Heavy Duty Tube Clamp Jaws

Aluminium



• Supplied in pairs

PGC: 224	Group	OD (mm)	Price
RCAR-106	1	6	£9.80
RCAR-108	1	8	£9.80
RCAR-109.5	1	9.5	£9.80
RCAR-110	1	10	£9.80
RCAR-112	1	12	£9.80
RCAR-112.7	1	12.7	£9.80
RCAR-113.5	1	13.5	£9.80
RCAR-114	1	14	£9.80
RCAR-115	1	15	£9.80
RCAR-116	1	16	£9.80
RCAR-117.2	1	17.2	£9.80
RCAR-118	1	18	£9.80
RCAR-219	2	19	£14.92
RCAR-220	2	20	£14.92
RCAR-221.3	2	21.3	£14.92
RCAR-222	2	22	£14.92
RCAR-223	2	23	£14.92
RCAR-225	2	25	£14.92
RCAR-225.4	2	25.4	£14.92
RCAR-226.9	2	26.9	£14.92
RCAR-228	2	28	£14.92
RCAR-230	2	30	£14.92
RCAR-330	3	30	£18.14
RCAR-332	3	32	£18.14
RCAR-333.7	3	33.7	£18.14
RCAR-335	3	35	£18.14
RCAR-338	3	38	£18.14
RCAR-340	3	40	£18.14
RCAR-342	3	42	£18.14
RCAR-438	4	38	£47.70
RCAR-440	4	40	£47.70
RCAR-442	4	42	£47.70
RCAR-445	4	45	£47.70
RCAR-448.3	4	48.3	£47.70
RCAR-450	4	50	£47.70
RCAR-451	4	51	£47.70
RCAR-452	4	52	£47.70
RCAR-455	4	55	£47.70
RCAR-457	4	57	£47.70
RCAR-460.3	4	60.3	£47.70
RCAR-463	4	63	£47.70
RCAR-465	4	65	£47.70
RCAR-470	4	70	£47.70

Weld Plates

Heavy Duty Weld Plate

Carbon Steel



PGC: 224	Group	Price
AP-C1	1	£4.48
AP-C2	2	£5.11
AP-C3	3	£5.55
AP-C4	4	£13.52
AP-C5	5	£26.89
AP-C6	6	£61.81
AP-C7	7	£79.34
AP-C8	8	£208.73
AP-C9	9	£390.00
AP-C10	10	£443.30

Stainless Steel

PGC: 224	Group	Price
AP-C1-SS	1	£7.56
AP-C2-SS	2	£8.55
AP-C3-SS	3	£9.31
AP-C4-SS	4	£22.66
AP-C5-SS	5	£39.96
AP-C6-SS	6	£83.61
AP-C7-SS	7	£260.78
AP-C8-SS	8	£442.02
AP-C9-SS	9	£515.06
AP-C10-SS	10	£541.91

Heavy Duty Extended Weld Plate

Carbon Steel



PGC: 224	Group	Price
APL-C1	1	£11.81
APL-C2	2	£11.96
APL-C3	3	£12.35
APL-C4	4	£20.14
APL-C5	5	£94.55
APL-C6	6	£137.41
APL-C7	7	£150.77
APL-C8	8	£273.94

Stainless Steel

PGC: 224	Group	Price
APL-C1-SS	1	£31.14
APL-C2-SS	2	£31.14
APL-C3-SS	3	£31.14
APL-C4-SS	4	£31.14
APL-C5-SS	5	£146.53
APL-C6-SS	6	£602.84
APL-C7-SS	7	£275.82
APL-C8-SS	8	£313.30

Heavy Duty Double Weld Plate

Carbon Steel



PGC: 224	Group	Price
APD-C1	1	£23.78
APD-C2	2	£24.17
APD-C3	3	£24.83
APD-C4	4	£35.28
APD-C5	5	£63.14
APD-C6	6	£143.69
APD-C7	7	£174.18
APD-C8	8	£370.12
APD-C9	9	£676.26
APD-C10	10	£775.06

Stainless Steel

PGC: 224	Group	Price
APD-C1-SS	1	£35.67
APD-C2-SS	2	£36.26
APD-C3-SS	3	£37.24
APD-C4-SS	4	£52.92
APD-C5-SS	5	£94.71
APD-C6-SS	6	£215.53
APD-C7-SS	7	£261.27
APD-C8-SS	8	£555.18
APD-C9-SS	9	£1014.39
APD-C10-SS	10	£1162.59

Heavy Duty Cover Plate

Carbon Steel



PGC: 224	Group	Price
DP-C1	1	£1.76
DP-C2	2	£2.01
DP-C3	3	£2.39
DP-C4	4	£4.93
DP-C5	5	£12.89
DP-C6	6	£28.72
DP-C7	7	£37.73
DP-C8	8	£97.19
DP-C9	9	£156.47
DP-C10	10	£188.19

Stainless Steel

PGC: 224	Group	Price
DP-C1-SS	1	£3.25
DP-C2-SS	2	£3.71
DP-C3-SS	3	£4.45
DP-C4-SS	4	£9.07
DP-C5-SS	5	£20.36
DP-C6-SS	6	£246.31
DP-C7-SS	7	£56.59
DP-C8-SS	8	£145.79
DP-C9-SS	9	£234.71
DP-C10-SS	10	£282.29

Heavy Duty Double Cover Plate

Carbon Steel



PGC: 224	Group	Price
DPD-C1	1	£6.11
DPD-C2	2	£7.41
DPD-C3	3	£7.85
DPD-C4	4	£23.08
DPD-C5	5	£43.11
DPD-C6	6	£84.91
DPD-C7	7	£91.45
DPD-C8	8	£217.72
DPD-C9	9	£261.82
DPD-C10	10	£311.79

Stainless Steel

PGC: 224	Group	Price
DPD-C1-SS	1	£12.21
DPD-C2-SS	2	£14.81
DPD-C3-SS	3	£15.69
DPD-C4-SS	4	£46.16
DPD-C5-SS	5	£86.22
DPD-C6-SS	6	£169.82
DPD-C7-SS	7	£182.90
DPD-C8-SS	8	£435.43
DPD-C9-SS	9	£523.64
DPD-C10-SS	10	£623.57

Bolts

Hexagon Head Bolt

Carbon Steel



PGC: 224	Group	Price
SS-C1	1	£0.58
SS-C2	2	£0.65
SS-C3	3	£0.73
SS-C4	4	£1.46
SS-C5	5	£3.78
SS-C6	6	£14.26
SS-C7	7	£21.73
SS-C8	8	£43.83
SS-C9	9	£56.39
SS-C10	10	£70.36

Stainless Steel

PGC: 224	Group	Price
SS-C1-SS	1	£6.39
SS-C2-SS	2	£6.40
SS-C3-SS	3	£7.43
SS-C4-SS	4	£14.77
SS-C5-SS	5	£33.95
SS-C6-SS	6	£83.04
SS-C7-SS	7	£103.95
SS-C8-SS	8	£146.15
SS-C9-SS	9	£187.86
SS-C10-SS	10	£218.92

Socket Head Bolt

Carbon Steel



PGC: 224	Group	Price
IS-C1	1	£0.77
IS-C2	2	£0.93
IS-C3	3	£1.18
IS-C4	4	£2.12
IS-C5	5	£6.45
IS-C6	6	£25.16
IS-C7	7	£37.22
IS-C8	8	£72.74

Stainless Steel

PGC: 224	Group	Price
IS-C1-SS	1	£5.96
IS-C2-SS	2	£7.67
IS-C3-SS	3	£8.89
IS-C4-SS	4	£19.09
IS-C5-SS	5	£50.64
IS-C6-SS	6	£176.62
IS-C7-SS	7	£207.57
IS-C8-SS	8	£229.72

Stacking Bolt

Carbon Steel



PGC: 224	Group	Price
AS-C1	1	£6.14
AS-C2	2	£6.31
AS-C3	3	£6.67
AS-C4	4	£8.94
AS-C5	5	£17.16
AS-C6	6	£43.27
AS-C7	7	£80.54
AS-C8	8	£173.52

Stainless Steel

PGC: 224	Group	Price
AS-C1-SS	1	£32.35
AS-C2-SS	2	£33.43
AS-C3-SS	3	£34.32
AS-C4-SS	4	£38.55
AS-C5-SS	5	£56.38
AS-C6-SS	6	£67.98
AS-C7-SS	7	£77.89
AS-C8-SS	8	£92.46

Locking Plates

Heavy Duty Locking Plate

Carbon Steel



PGC: 224	Group	Price
SP-C1	1	£3.30
SP-C2	2	£3.69
SP-C3	3	£4.08
SP-C4	4	£10.53
SP-C5	5	£19.73
SP-C6	6	£45.47
SP-C7	7	£100.40
SP-C8	8	£162.79

Stainless Steel

PGC: 224	Group	Price
SP-C1-SS	1	£11.21
SP-C2-SS	2	£16.38
SP-C3-SS	3	£18.23
SP-C4-SS	4	£34.61
SP-C5-SS	5	£46.01
SP-C6-SS	6	£58.11
SP-C7-SS	7	£67.49
SP-C8-SS	8	£83.19

Mounting Rails

Mounting Rail

Carbon Steel



PGC: 224	Depth (mm)	Length (m)	Price
MR-22	22	1	£19.79
MR-22-2	22	2	£39.57



Light Series Tube Clamps & Accessories

LB / LBG TYPE

Applications include:

- Pneumatics
- Automotive technology
- Machine tool industry
- Lubrication
- Mechanical engineering
- Naval technology
- Also suitable for cables and hose



Manufactured according to DIN 3015 Part 1.

Single Tube Clamps

Single Light Series Clamp

Metric
Polypropylene Jaws

Temperature Range:
-25°C to +90°C

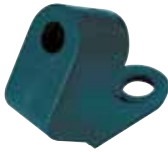

- Manufactured to DIN 3015
- Supplied in pairs

PGC: 224	OD (mm)	Price
LB6-PP	6	£0.21
LB8-PP	8	£0.21
LB10-PP	10	£0.28
LB12-PP	12	£0.28
LB14-PP	14	£0.38
LB15-PP	15	£0.38
LB16-PP	16	£0.38
LB18-PP	18	£0.38
LB20-PP	20	£0.56
LB22-PP	22	£0.56
LB25-PP	25	£0.56

Imperial OD

PGC: 224	OD (")	Price
LB1/4-PP	1/4	£0.21
LB3/8-PP	3/8	£0.28
LB1/2-PP	1/2	£0.42
LB3/4-PP	3/4	£0.56
LB1-PP	1	£0.56

Imperial NB

PGC: 224	NB (")	Price
LB1/4N-PP	1/4	£0.28
LB3/8N-PP	3/8	£0.38
LB1/2N-PP	1/2	£0.38

Single Light Series Clamp

Metric
Polyamide Jaws

Temperature Range:
-30°C to +120°C



- Fire retardant Polyamide 6 jaws
- Manufactured to DIN 3015
- Supplied in pairs

PGC: 224	OD (mm)	Price
LB6-PA	6	£0.31
LB8-PA	8	£0.31
LB10-PA	10	£0.55
LB12-PA	12	£0.55
LB14-PA	14	£0.86
LB15-PA	15	£0.86
LB16-PA	16	£0.86
LB18-PA	18	£0.86
LB20-PA	20	£1.23
LB22-PA	22	£1.23
LB25-PA	25	£1.23

Imperial OD

PGC: 224	OD (")	Price
LB1/4-PA	1/4	£0.31
LB3/8-PA	3/8	£0.55
LB1/2-PA	1/2	£0.55
LB3/4-PA	3/4	£1.23
LB1-PA	1	£1.23

Imperial NB

PGC: 224	NB (")	Price
LB1/4N-PA	1/4	£0.55
LB3/8N-PA	3/8	£0.86
LB1/2N-PA	1/2	£0.86

Double Tube Clamps

Double Light Series Clamp

Metric
Polypropylene Jaws

Temperature Range:
-25°C to +90°C



PGC: 224	OD (mm)	Price
LBG6-PP	6	£0.28
LBG8-PP	8	£0.28
LBG10-PP	10	£0.38
LBG12-PP	12	£0.38
LBG14-PP	14	£0.65
LBG15-PP	15	£0.65
LBG16-PP	16	£0.65
LBG18-PP	18	£0.65
LBG20-PP	20	£0.88
LBG22-PP	22	£0.88
LBG25-PP	25	£0.88

Imperial OD

PGC: 224	OD (")	Price
LBG1/4-PP	1/4	£0.28
LBG3/8-PP	3/8	£0.38
LBG1/2-PP	1/2	£0.38
LBG3/4-PP	3/4	£0.88

Double Light Series Clamp

Metric
Polyamide Jaws

Temperature Range:
-30°C to +120°C



- Fire retardant Polyamide 6 jaws
- Manufactured to DIN 3015
- Supplied in pairs

PGC: 224	OD (mm)	Price
LBG6-PA	6	£0.43
LBG8-PA	8	£0.43
LBG10-PA	10	£0.86
LBG12-PA	12	£0.86
LBG14-PA	14	£1.42
LBG15-PA	15	£1.42
LBG16-PA	16	£1.42
LBG18-PA	18	£1.42
LBG20-PA	20	£1.80
LBG22-PA	22	£1.80
LBG25-PA	25	£1.80

Imperial OD

PGC: 224	OD (")	Price
LBG1/4-PA	1/4	£0.43
LBG3/8-PA	3/8	£0.86
LBG1/2-PA	1/2	£0.86
LBG3/4-PA	3/4	£1.80
LBG1-PA	1	£1.80



Light Series Tube Clamps & Accessories

LN / LNG TYPE

Applications include:

- Instrumentation
- Pneumatics
- Hydraulics
- Lubrication
- Mechanical engineering
- Automotive technology
- Machine tool industry
- Also suitable for cables and hose



Manufactured according to DIN 3015 Part 1.

Single Tube Clamps

Single Light Series Clamp

Metric
Polypropylene Jaws



Temperature Range:
-25°C to +90°C



- Manufactured to DIN 3015
- Supplied in pairs

PGC: 224	OD (mm)	Price
LN6-PP	6	£0.31
LN8-PP	8	£0.31
LN10-PP	10	£0.38
LN12-PP	12	£0.38
LN14-PP	14	£0.38
LN15-PP	15	£0.38
LN16-PP	16	£0.38
LN18-PP	18	£0.44
LN20-PP	20	£0.44
LN22-PP	22	£0.44

Imperial OD

PGC: 224	OD (")	Price
LN1/4-PP	1/4	£0.31
LN3/8-PP	3/8	£0.39
LN1/2-PP	1/2	£0.33
LN3/4-PP	3/4	£0.44

Imperial NB

PGC: 224	NB (")	Price
LN1/4N-PP	1/4	£0.38
LN3/8N-PP	3/8	£0.38
LN1/2N-PP	1/2	£0.44

Single Light Series Clamp

Metric
Polyamide Jaws



Temperature Range:
-30°C to +120°C



FIRE RETARDANT



- Fire retardant Polyamide 6 jaws
- Manufactured to DIN 3015
- Supplied in pairs

PGC: 224	OD (mm)	Price
LN6-PA	6	£0.33
LN8-PA	8	£0.33
LN10-PA	10	£0.80
LN12-PA	12	£0.80
LN14-PA	14	£0.80
LN15-PA	15	£0.80
LN16-PA	16	£0.80
LN18-PA	18	£0.95
LN20-PA	20	£0.95
LN22-PA	22	£0.95

Imperial OD

PGC: 224	OD (")	Price
LN1/4-PA	1/4	£0.33
LN3/8-PA	3/8	£0.56
LN1/2-PA	1/2	£0.56
LN3/4-PA	3/4	£0.95

Imperial NB

PGC: 224	NB (")	Price
LN1/4N-PA	1/4	£0.80
LN3/8N-PA	3/8	£0.80
LN1/2N-PA	1/2	£0.95

Double Tube Clamps

Double Light Series Clamp

Metric
Polypropylene Jaws



Temperature Range:
-25°C to +90°C



- Manufactured to DIN 3015
- Supplied in pairs

PGC: 224	OD (mm)	Price
LN6-PP	6	£0.36
LN8-PP	8	£0.36
LN10-PP	10	£0.65
LN12-PP	12	£0.65
LN14-PP	14	£0.65
LN15-PP	15	£0.65
LN16-PP	16	£0.65
LN18-PP	18	£0.88
LN20-PP	20	£0.88
LN22-PP	22	£0.88

Imperial OD

PGC: 224	OD (mm)	Price
LN1/4-PP	1/4	£0.33
LN3/8-PP	3/8	£0.44
LN1/2-PP	1/2	£0.65
LN3/4-PP	3/4	£0.88

Double Light Series Clamp

Metric
Polyamide Jaws



Temperature Range:
-30°C to +120°C



FIRE RETARDANT

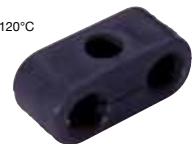

- Fire retardant Polyamide 6 jaws
- Manufactured to DIN 3015
- Supplied in pairs

PGC: 224	OD (mm)	Price
LN6-PA	6	£0.63
LN8-PA	8	£0.63
LN10-PA	10	£1.23
LN12-PA	12	£1.23
LN14-PA	14	£1.23
LN15-PA	15	£1.23
LN16-PA	16	£1.23
LN18-PA	18	£1.89
LN20-PA	20	£1.89
LN22-PA	22	£1.89

Imperial OD

PGC: 224	OD (")	Price
LN1/4-PA	1/4	£0.63
LN3/8-PA	3/8	£0.80
LN1/2-PA	1/2	£1.23
LN3/4-PA	3/4	£1.89

BSP Adaptors

- Manufactured to BS EN 10277 1 & 3 - 11SMnPb30
- Manufactured from steel
- BSP threads to BS ENISO228-1:2003
- BSPT threads to BS EN 10226-1:2004
- For use in: Agriculture, Transport, Waste, Defence, Manufacturing, Marine, Construction, Mining, Engineering, Hydraulics



Working Pressure Range:
350 bar (5145 psi) up to 450 bar (6500 psi)
according to NB (see table)

Adaptor Pressure Ratings Applicable to Bore Size Only

NB Diameter	Working Pressure (bar / psi)
5 mm (1/8")	350 / 5145
6.3 mm (1/4")	450 / 6500
10 mm (3/8")	380 / 5500
12.5 mm (1/2")	310 / 4500
14.25 mm (9/16")	289 / 4250
16 mm (5/8")	280 / 4000
19 mm (3/4")	240 / 3500
25 mm (1")	210 / 3000
31.5 mm (1 1/4")	170 / 2500
37.5 mm (1 1/2")	136 / 2000
50 mm (2")	136 / 2000
62.5 mm (2 1/2")	84 / 1240
75 mm (3")	76 / 1120

Male Adaptors & Bulkheads

Male Adaptor

Male Thread BSPP
60° Cone



PGC: 408	BSPP 1	BSPP 2	Price
BH-00001	1/8	1/8	£1.79
BH-00002	1/8	1/4	£2.00
BH-00003	1/8	3/8	£2.42
BH-00004	1/8	1/2	£3.31
BH-00005	1/4	1/4	£1.79
BH-00006	1/4	3/8	£2.16
BH-00007	1/4	1/2	£2.58
BH-00008	1/4	5/8	£4.94
BH-00009	1/4	3/4	£6.15
BH-00010	1/4	1	£9.56
BH-00011	1/4	1 1/4	£32.55
BH-00012	1/4	1 1/2	£39.48
BH-00013	1/4	2	£53.82
BH-00014	3/8	3/8	£2.16
BH-00015	3/8	1/2	£2.58
BH-00016	3/8	5/8	£3.63
BH-00017	3/8	3/4	£4.73
BH-00018	3/8	1	£9.56
BH-00019	3/8	1 1/4	£26.78
BH-00020	3/8	1 1/2	£30.87
BH-00060	3/8	2	£53.97
BH-00021	1/2	1/2	£2.58
BH-00022	1/2	5/8	£3.42
BH-00023	1/2	3/4	£4.41
BH-00024	1/2	1	£7.72
BH-00025	1/2	1 1/4	£26.78
BH-00026	1/2	1 1/2	£32.71
BH-00027	1/2	2	£41.22
BH-00028	5/8	5/8	£3.42
BH-00029	5/8	3/4	£4.41
BH-00030	5/8	1	£7.83
BH-00031	5/8	1 1/4	£26.78
BH-00069	5/8	1 1/2	£44.26
BH-00032	3/4	3/4	£4.41
BH-00033	3/4	1	£7.72
BH-00034	3/4	1 1/4	£25.62
BH-00035	3/4	1 1/2	£29.61
BH-00036	3/4	2	£39.54
BH-00037	1	1	£7.41
BH-00038	1	1 1/4	£17.33
BH-00039	1	1 1/2	£22.05
BH-00040	1	2	£34.65

PGC: 408	BSPP 1	BSPP 2	Price
BH-00040	1	2	£34.65
BH-00051	1	2 1/2	£84.37
BH-00042	1 1/4	1 1/4	£15.91
BH-00043	1 1/4	1 1/2	£20.53
BH-00044	1 1/4	2	£34.65
BH-00041	1 1/4	2 1/2	£84.37
BH-00045	1 1/2	1 1/2	£19.38
BH-00046	1 1/2	1 3/4	£24.94
BH-00047	1 1/2	2	£31.35
BH-00048	1 1/2	2 1/2	£84.37
BH-00057	1 3/4	1 3/4	£24.94
BH-00049	1 3/4	2	£34.65
BH-00058	1 3/4	2 1/2	£84.37
BH-00050	2	2	£31.35

Male Equal Bulkhead

Male Thread BSP with Locknut



PGC: 408	BSP	Price
BH-09500	1/8	£7.35
BH-09501	1/4	£6.36
BH-09502	3/8	£7.14
BH-09503	1/2	£7.67
BH-09504	5/8	£8.98
BH-09506	3/4	£13.13
BH-09507	1	£18.17
BH-09508	1 1/4	£35.86
BH-09509	1 1/2	£67.78
BH-09510	2	£92.93
BH-09516	2 1/2	£187.17
BH-09517	3	£301.77

Male Adaptor

Male Thread BSPP & BSPT
60° Cone



PGC: 408	BSPP	BSPT	Price
BH-00301	1/8	1/8	£2.05
BH-00302	1/8	1/4	£2.31
BH-00303	1/8	3/8	£3.00
BH-00304	1/8	1/2	£7.30
BH-00305	1/4	1/8	£2.31
BH-00306	1/4	1/4	£2.05
BH-00307	1/4	3/8	£2.58
BH-00308	1/4	1/2	£3.52
BH-00310	1/4	3/4	£6.15
BH-00311	3/8	1/8	£3.52
BH-00312	3/8	1/4	£2.84
BH-00313	3/8	3/8	£2.58
BH-00314	3/8	1/2	£3.52
BH-00315	3/8	5/8	£4.94
BH-00316	3/8	3/4	£5.94
BH-00317	3/8	1	£10.61
BH-00318	1/2	1/8	£4.73
BH-00319	1/2	1/4	£3.52
BH-00320	1/2	3/8	£3.31
BH-00321	1/2	1/2	£2.84
BH-00322	1/2	5/8	£4.05
BH-00323	1/2	3/4	£4.89
BH-00324	1/2	1	£8.35
BH-00360	1/2	1 1/4	£19.11
BH-00325	5/8	1/4	£4.94
BH-00326	5/8	3/8	£5.41
BH-00327	5/8	1/2	£3.84
BH-00328	5/8	5/8	£3.84
BH-00329	5/8	3/4	£6.15
BH-00330	3/4	1/4	£7.04
BH-00331	3/4	3/8	£6.57
BH-00332	3/4	1/2	£4.83
BH-00333	3/4	5/8	£5.94
BH-00334	3/4	3/4	£4.47
BH-00335	3/4	1	£8.35
BH-00336	3/4	1 1/4	£30.19
BH-00365	3/4	1 1/2	£30.19
BH-00367	3/4	2	£158.76
BH-00337	1	1/4	£30.19
BH-00361	1	3/8	£10.61
BH-00338	1	1/2	£8.35
BH-00339	1	3/4	£8.35
BH-00340	1	1	£8.35
BH-00341	1	1 1/4	£18.33
BH-00342	1	1 1/2	£21.95
BH-00343	1	2	£39.69
BH-00344	1 1/4	3/4	£19.11
BH-00345	1 1/4	1	£19.11
BH-00346	1 1/4	1 1/4	£17.64
BH-00347	1 1/4	1 1/2	£22.89
BH-00348	1 1/4	2	£26.46
BH-00349	1 1/2	1	£26.46
BH-00350	1 1/2	1 1/4	£22.89
BH-00351	1 1/2	1 1/2	£21.95
BH-00352	1 1/2	2	£37.23
BH-00353	2	1	£37.96
BH-00354	2	1 1/4	£37.96
BH-00355	2	1 1/2	£37.23
BH-00356	2	2	£36.70

Female Adaptors

Female Swivel Adaptor

Female Thread BSPP



PGC: 408	BSPP 1	BSPP 2	Price
BH-01725	1/8	1/8	£3.73
BH-01726	1/8	1/4	£3.99
BH-01751	1/8	3/8	£4.41
BH-01727	1/4	1/4	£3.31
BH-01728	1/4	3/8	£3.47
BH-01732	1/4	1/2	£4.89
BH-01736	1/4	5/8	£6.25
BH-01724	1/4	3/4	£8.35
BH-01729	3/8	3/8	£3.47
BH-01733	3/8	1/2	£4.78
BH-01737	3/8	5/8	£5.88
BH-01730	3/8	3/4	£8.35
BH-01731	3/8	1*	£11.71
BH-01734	1/2	1/2	£4.78
BH-01746	1/2	5/8	£5.83
BH-01735	1/2	3/4	£8.35
BH-01750	1/2	1*	£12.08
BH-01738	5/8	5/8	£5.88
BH-01740	5/8	3/4	£8.35
BH-01739	5/8	1	£10.87
BH-01741	3/4	3/4	£7.56
BH-01742	3/4	1	£10.87
BH-01747	3/4	1 1/4	£22.05
BH-01743	1	1	£10.87
BH-01744	1	1 1/4	£22.05
BH-01752	1	1 1/2	£36.81
BH-01745	1 1/4	1 1/4	£22.05
BH-01753	1 1/4	1 1/2	£38.59
BH-01756	1 1/4	2	£72.72
BH-01748	1 1/2	1 1/2	£38.59
BH-01755	1 1/2	2	£72.72
BH-01749	2	2	£72.72

Female Compact 90° Swivel Elbow

Female Thread BSPP



PGC: 408	BSPP	Price
BH-05025	1/8	£3.73
BH-05026	1/4	£3.99
BH-05027	3/8	£10.87
BH-05028	1/2	£14.65
BH-05029	5/8	£18.01
BH-05030	3/4	£20.74
BH-05031	1	£25.47
BH-05032	1 1/4	£58.96
BH-05033	1 1/2	£131.10
BH-05034	2	£184.33

Female Swivel Tee

Female Thread BSPP



PGC: 408	BSPP	Price
BH-01975	1/8	£10.92
BH-01976	1/4	£11.45
BH-01977	3/8	£12.76
BH-01978	1/2	£15.23
BH-01979	5/8	£21.06
BH-01980	3/4	£24.10
BH-01981	1	£32.87
BH-01982	1 1/4	£90.25
BH-01983	1 1/2	£157.61
BH-01984	2	£204.39

Male Female Adaptors

Male Female Swivel Compact Elbow 90°

Male to Female Thread BSPP

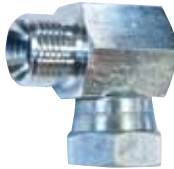

PGC: 408	BSPP	Price
BH-04012	1/8	£8.14
BH-04014	1/4	£8.14
BH-04015	3/8	£11.61
BH-04016	1/2	£12.45
BH-04020	5/8	£16.33
BH-04017	3/4	£20.22
BH-04018	1	£33.45
BH-04019	1 1/4	£57.23
BH-04025	1 1/2	£112.98
BH-04023	2	£159.08

Male Female Swivel Connector

Male to Female Thread BSPP



PGC: 408	BSPP	BSPP	Price
BH-01425	1/8	1/8	£3.73
BH-01426	1/8	1/4	£3.73
BH-01476	1/8	3/8	£3.73
BH-01428	1/4	1/8	£3.73
BH-01427	1/4	1/4	£3.00
BH-01429	1/4	3/8	£3.47
BH-01430	1/4	1/2	£4.83
BH-01431	1/4	3/4	£9.56
BH-01432	3/8	1/8	£3.99
BH-01433	3/8	1/4	£3.47
BH-01434	3/8	3/8	£3.42
BH-01435	3/8	1/2	£4.73
BH-01470	3/8	5/8	£8.72
BH-01436	3/8	3/4	£8.93
BH-01437	3/8	1	£10.66
BH-01438	1/2	1/4	£4.83
BH-01439	1/2	3/8	£4.73
BH-01440	1/2	1/2	£4.73
BH-01441	1/2	5/8	£5.67
BH-01442	1/2	3/4	£6.93
BH-01443	1/2	1	£10.35
BH-01457	5/8	1/4	£8.72
BH-01444	5/8	3/8	£8.72
BH-01445	5/8	1/2	£5.67
BH-01446	5/8	5/8	£5.41
BH-01447	5/8	3/4	£8.93
BH-01481	5/8	1	£12.13
BH-01487	5/8	1 1/2	£49.35
BH-01468	3/4	1/4	£8.93
BH-01448	3/4	3/8	£8.93
BH-01449	3/4	1/2	£6.93
BH-01450	3/4	5/8	£8.93
BH-01451	3/4	3/4	£6.93
BH-01453	3/4	1	£10.66
BH-01452	3/4	1 1/4	£23.10
BH-01482	3/4	1 1/2	£33.45
BH-01484	1	3/8	£10.66
BH-01454	1	1/2	£10.66
BH-01455	1	5/8	£10.66
BH-01456	1	3/4	£10.66
BH-01458	1	1	£10.24
BH-01463	1	1 1/4	£21.27
BH-01472	1	1 1/2	£33.45
BH-01479	1	2	£56.86
BH-01459	1 1/4	1/2	£22.89
BH-01469	1 1/4	3/4	£21.27
BH-01460	1 1/4	1	£21.27
BH-01461	1 1/4	1 1/4	£21.27
BH-01462	1 1/4	1 1/2	£32.24
BH-01477	1 1/4	2	£56.86
BH-01464	1 1/2	1	£32.24
BH-01465	1 1/2	1 1/4	£32.24
BH-01466	1 1/2	1 1/2	£33.45
BH-01471	1 1/2	2	£56.86
BH-01475	2	1 1/4	£56.86
BH-01474	2	1 1/2	£56.86
BH-01467	2	2	£56.86

Female Fixed Connector

Female Thread BSPP

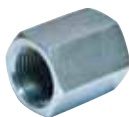

PGC: 408	BSPP1	BSPP2	Price
BH-09000	1/8	1/8	£3.73
BH-09001	1/8	1/4	£5.41
BH-09002	1/4	1/4	£2.84
BH-09003	1/4	3/8	£5.67
BH-09016	1/4	1/2	£6.15
BH-09004	3/8	3/8	£3.31
BH-09006	3/8	1/2	£6.15
BH-09021	3/8	3/4	£9.87
BH-09005	1/2	1/2	£3.42
BH-09008	1/2	5/8	£9.87
BH-09007	1/2	3/4	£8.82
BH-09017	1/2	1	£15.12
BH-09009	5/8	5/8	£4.78
BH-09010	3/4	3/4	£6.93
BH-09015	3/4	1	£15.12
BH-09011	1	1	£11.61
BH-09018	1	1 1/4	£26.04
BH-09023	1	1 1/2	£37.02
BH-09012	1 1/4	1 1/4	£22.05
BH-09022	1 1/4	1 1/2	£37.02
BH-09013	1 1/2	1 1/2	£35.34
BH-09014	2"	2"	£57.96

Plugs

Solid Plug

Male Thread BSPT



PGC: 408	BSPT	Price
BH-09075	1/8	£1.58
BH-09076	1/4	£1.79
BH-09077	3/8	£2.31
BH-09078	1/2	£2.37
BH-09079	5/8	£3.42
BH-09080	3/4	£3.84
BH-09081	1	£6.71
BH-09082	1 1/4	£13.18
BH-09083	1 1/2	£18.38
BH-09084	2	£30.61
BH-09085	2 1/2	£129.42
BH-09086	3"	£189.48

Solid Plug

Male Thread BSPP



PGC: 408	BSPP	Price
BH-09025	1/8	£1.53
BH-09026	1/4	£1.58
BH-09027	3/8	£2.16
BH-09028	1/2	£2.31
BH-09029	5/8	£3.31
BH-09030	3/4	£3.63
BH-09031	1"	£5.52
BH-09032	1 1/4	£12.45
BH-09033	1 1/2	£17.07
BH-09034	2"	£26.78
BH-09036	2 1/2	£130.31
BH-09037	3"	£105.37

Coned Plug

Male Thread BSPP



PGC: 408	BSPP	Price
BH-09050	1/8	£1.53
BH-09051	1/4	£1.58
BH-09052	3/8	£2.16
BH-09053	1/2	£2.37
BH-09054	5/8	£3.36
BH-09055	3/4	£3.73
BH-09056	1	£5.67
BH-09057	1 1/4	£12.60
BH-09058	1 1/2	£17.64
BH-09059	2	£27.20
BH-09060	2 1/2	£73.40
BH-09061	3	£105.37
BH-09062	4	£189.48

Push-in Hose Inserts

Female Push-In Hose Insert

Female Thread BSPP



PGC: 408	ID (")	BSPP	Price
BH-09240	1/4	1/4	£2.58
BH-09246	1/4	3/8	£9.98
BH-09241	3/8	3/8	£3.29
BH-09242-06	3/8	1/2	£4.47
BH-09242	1/2	1/2	£4.26
BH-09243	5/8	5/8	£5.94
BH-09244	3/4	3/4	£8.14
BH-09245	1	1	£13.90

Male Push-In Hose Insert

Male Thread BSPP



PGC: 408	ID (")	BSPP	Price
BH-09220	1/4	1/4	£3.36
BH-09221	3/8	3/8	£4.02
BH-09222	1/2	1/2	£4.94
BH-09225	5/8	5/8	£6.62
BH-09223	3/4	3/4	£8.46
BH-09224	1	1	£16.02

Male Push-In Hose Insert

Male Thread BSPT



PGC: 408	ID (")	BSPT	Price
BH-09258	1/4	1/8	£4.41
BH-09250	1/4	1/4	£4.41
BH-09251	3/8	3/8	£7.14
BH-09256	3/8	1/2	£8.98
BH-09252	1/2	3/8	£8.98
BH-09253	1/2	1/2	£5.17
BH-09254	3/4	3/4	£11.66
BH-09255	1	1	£19.59

Female 90° Push-In Hose Insert

Female Thread BSPP



PGC: 408	ID (")	BSPP	Price
BH-09280	1/4	1/4	£9.87
BH-09281	3/8	3/8	£11.50
BH-09282	1/2	1/2	£15.20
BH-09283	5/8	5/8	£18.90
BH-09284	3/4	3/4	£20.85
BH-09285	1	1	£39.69

Female 135° Push-In Hose Insert

Female Thread BSPP



PGC: 408	ID (")	BSPP	Price
BH-19280	1/4	1/4	£9.87
BH-19281	3/8	3/8	£11.50
BH-19282	1/2	1/2	£13.86
BH-19283	5/8	5/8	£18.90
BH-19284	3/4	3/4	£20.85
BH-19285	1	1	£39.69



BSP Adaptors



- Manufactured to BS 5200
- BSP thread to BS 2779
- Trivalent passivate surface plating for ELVD (2000/53/EC) compliancy
- Male threads are capped for full protection

Working Pressure Range:



350 bar (5076 psi) up to 450 bar (6526 psi) according to NB* (see table)

*Does not apply to swept elbows

Male Adaptors

Male Adaptor

BSP to BSPT
60° Cone



PGC: 283	BSP	BSPT	Price
MM2PT	1/8	1/8	£1.40
MM2P4T	1/8	1/4	£1.84
MM2P6T	1/8	3/8	£2.27
MM2P8T	1/8	1/2	£6.85
MM4P2T	1/4	1/8	£5.66
MM4P4T	1/4	1/4	£1.14
MM4P6T	1/4	3/8	£1.40
MM4P8T	1/4	1/2	£2.60
MM4P12T	1/4	3/4	£5.66
MM6P2T	3/8	1/8	£2.52
MM6P4T	3/8	1/4	£1.59
MM6P6T	3/8	3/8	£1.52
MM6P8T	3/8	1/2	£1.90
MM6P12T	3/8	3/4	£5.66
MM6P16T	3/8	1	£10.05
MM8P2T	1/2	1/8	£4.40
MM8P4T	1/2	1/4	£2.60
MM8P6T	1/2	3/8	£1.71
MM8P8T	1/2	1/2	£1.71
MM8P12T	1/2	3/4	£3.53
MM8P16T	1/2	1	£7.67
MM10P8T	5/8	1/2	£3.71
MM10PT	5/8	5/8	£3.71
MM12P4T	3/4	1/4	£4.97
MM12P6T	3/4	3/8	£4.53
MM12P8T	3/4	1/2	£3.27
MM12P10T	3/4	5/8	£5.66
MM12PT	3/4	3/4	£2.79
MM12P16T	3/4	1	£7.86
MM12P20T	3/4	1 1/4	£17.90
MM12P24T	3/4	1 1/2	£27.56
MM16P4T	1	1/4	£27.56
MM16P6T	1	3/8	£9.75
MM16P8T	1	1/2	£7.86
MM16P12T	1	3/4	£6.04
MM16PT	1	1	£6.04
MM16P20T	1	1 1/4	£16.89
MM16P24T	1	1 1/2	£20.03
MM20P12T	1 1/4	3/4	£17.51
MM20P16T	1 1/4	1	£17.51
MM20PT	1 1/4	1 1/4	£11.30
MM20P24T	1 1/4	1 1/2	£20.72
MM24P16T	1 1/2	1	£10.37
MM24P20T	1 1/2	1 1/4	£20.72
MM24PT	1 1/2	1 1/2	£11.62
MM24P32T	1 1/2	2	£33.88
MM32P20T	2	1 1/4	£34.50
MM32P24T	2	1 1/2	£33.88
MM32PT	2	2	£33.25

NB Diameter	Working Pressure (bar / psi)
5 mm (1/8")	350 / 5076
6.3 mm (1/4")	450 / 6526
10 mm (3/8")	380 / 5511
12.5 mm (1/2")	310 / 4496
14.25 mm (9/16")	289 / 4191
16 mm (5/8")	280 / 4061
19 mm (3/4")	240 / 3480
25 mm (1")	210 / 3045
31.5 mm (1 1/4")	170 / 2465
37.5 mm (1 1/2")	136 / 1972
50 mm (2")	136 / 1972
62.5 mm (2 1/2")	84 / 1218

Male Adaptor

BSP to JIC
60° Cone



PGC: 283	Thread	BSP	Price
MM-J7/16-1/8P	7/16 JIC	1/8	£2.02
MM-J7/16-1/4P	7/16 JIC	1/4	£1.90
MM-J7/16-3/8P	7/16 JIC	3/8	£2.47
MM-J7/16-1/2P	7/16 JIC	1/2	£3.27
MM-J7/16-3/4P	7/16 JIC	3/4	£5.35
MM-J1/2-1/8P	1/2 JIC	1/8	£3.48
MM-J1/2-1/4P	1/2 JIC	1/4	£1.59
MM-J1/2-3/8P	1/2 JIC	3/8	£1.59
MM-J1/2-1/2P	1/2 JIC	1/2	£3.48
MM-J9/16-1/8P	9/16 JIC	1/8	£3.48
MM-J9/16-1/4P	9/16 JIC	1/4	£1.59
MM-J9/16-3/8P	9/16 JIC	3/8	£1.59
MM-J9/16-1/2P	9/16 JIC	1/2	£1.96
MM-J9/16-3/4P	9/16 JIC	3/4	£5.35
MM-J9/16-1P	9/16 JIC	1	£12.00
MM-J3/4-1/4P	3/4 JIC	1/4	£2.34
MM-J3/4-3/8P	3/4 JIC	3/8	£1.90
MM-J3/4-1/2P	3/4 JIC	1/2	£1.90
MM-J3/4-3/4P	3/4 JIC	3/4	£3.27
MM-J3/4-1P	3/4 JIC	1	£1.90
MM-J7/8-1/4P	7/8 JIC	1/4	£5.35
MM-J7/8-3/8P	7/8 JIC	3/8	£2.34
MM-J7/8-1/2P	7/8 JIC	1/2	£2.34
MM-J7/8-3/4P	7/8 JIC	3/4	£3.27
MM-J7/8-1P	7/8 JIC	1	£8.49
MM-J11/16-1/4P	11/16 JIC	1/4	£9.75
MM-J11/16-3/8P	11/16 JIC	3/8	£4.91
MM-J11/16-1/2P	11/16 JIC	1/2	£2.96
MM-J11/16-3/4P	11/16 JIC	3/4	£3.03
MM-J11/16-1P	11/16 JIC	1	£5.54
MM-J11/16-1 1/4P	11/16 JIC	1 1/4	£18.51
MM-J11/16-1 1/2P	11/16 JIC	1 1/2	£27.73
MM-J13/16-3/4P	13/16 JIC	3/4	£6.41
MM-J15/16-1/4P	15/16 JIC	1/4	£9.75
MM-J15/16-3/8P	15/16 JIC	3/8	£8.17
MM-J15/16-1/2P	15/16 JIC	1/2	£8.17
MM-J15/16-3/4P	15/16 JIC	3/4	£5.54
MM-J15/16-1P	15/16 JIC	1	£5.54
MM-J15/16-1 1/4P	15/16 JIC	1 1/4	£18.51
MM-J15/16-1 1/2P	15/16 JIC	1 1/2	£28.56
MM-J15/8-3/4P	1 5/8 JIC	3/4	£22.04
MM-J15/8-1P	1 5/8 JIC	1	£19.39
MM-J15/8-1 1/4P	1 5/8 JIC	1 1/4	£19.39
MM-J15/8-1 1/2P	1 5/8 JIC	1 1/2	£28.18
MM-J17/8-1P	1 7/8 JIC	1	£28.18
MM-J17/8-1 1/4P	1 7/8 JIC	1 1/4	£28.18
MM-J17/8-1 1/2P	1 7/8 JIC	1 1/2	£28.18
MM-J21/2-2P	2 1/2 JIC	2	£42.79

Male Adaptor

BSP to BSPP
60° Cone



PGC: 283	BSP 1	BSP 2	Price
MM2P	1/8	1/8	£1.09
MM4-2P	1/4	1/8	£1.02
MM4P	1/4	1/4	£0.96
MM6-2P	3/8	1/8	£1.59
MM6-4P	3/8	1/4	£1.14
MM6P	3/8	3/8	£1.09
MM8-2P	1/2	1/8	£2.22
MM8-4P	1/2	1/4	£1.71
MM8-6P	1/2	3/8	£1.64
MM8P	1/2	1/2	£1.59
MM10-8P	5/8	1/2	£2.27
MM10P	5/8	5/8	£2.27
MM12-4P	3/4	1/4	£3.22
MM12-6P	3/4	3/8	£2.52
MM12-8P	3/4	1/2	£2.39
MM12-10P	3/4	5/8	£2.60
MM12P	3/4	3/4	£2.34
MM16-4P	1	1/4	£8.54
MM16-6P	1	3/8	£4.40
MM16-8P	1	1/2	£4.40
MM16-12P	1	3/4	£4.16
MM16P	1	1	£4.16
MM20-4P	1 1/4	1/4	£27.30
MM20-6P	1 1/4	3/8	£21.90
MM20-8P	1 1/4	1/2	£21.90
MM20-12P	1 1/4	3/4	£9.75
MM20-16P	1 1/4	1	£9.11
MM20P	1 1/4	1 1/4	£9.11
MM24-4P	1 1/2	1/4	£35.45
MM24-6P	1 1/2	3/8	£25.80
MM24-8P	1 1/2	1/2	£27.05
MM24-12P	1 1/2	3/4	£10.37
MM24-16P	1 1/2	1	£10.37
MM24-20P	1 1/2	1 1/4	£16.89
MM24P	1 1/2	1 1/2	£9.75
MM32-8P	2	1 1/2	£34.19
MM32-12P	2	3/4	£32.75
MM32-16P	2	1	£26.92
MM32-20P	2	1 1/4	£24.98
MM32-24P	2	1 1/2	£24.60
MM32P	2	2	£18.51

Male Adaptor

BSP to SAE
60° Cone



* Supplied complete with O-ring

PGC: 283	Thread	BSP	Price
MM-S7/16-1/4P	7/16 SAE	1/4	£1.64
MM-S7/16-3/8P	7/16 SAE	3/8	£1.96
MM-S9/16-1/4P	9/16 SAE	1/4	£1.96
MM-S9/16-3/8P	9/16 SAE	3/8	£1.90
MM-S9/16-1/2P	9/16 SAE	1/2	£3.71
MM-S3/4-3/8P	3/4 SAE	3/8	£2.47
MM-S3/4-1/2P	3/4 SAE	1/2	£2.47
MM-S3/4-3/4P	3/4 SAE	3/4	£5.66
MM-S7/8-3/8P	7/8 SAE	3/8	£4.53
MM-S7/8-1/2P	7/8 SAE	1/2	£2.78
MM-S7/8-5/8P	7/8 SAE	5/8	£4.53
MM-S7/8-3/4P	7/8 SAE	3/4	£5.61
MM-S11/16-1/2P	11/16 SAE	1/2	£5.78
MM-S11/16-3/4P	11/16 SAE	3/4	£4.22
MM-S11/16-1P	11/16 SAE	1	£8.67
MM-S15/16-3/4P	15/16 SAE	3/4	£8.67
MM-S15/16-1P	15/16 SAE	1	£8.67
MM-S15/8-1P	1 5/8 SAE	1	£20.15
MM-S17/8-1P	1 5/8 SAE	1	£30.87



Male Adaptor

BSP to Metric
60° Cone



PGC: 283	BSP	Thread	Price
MM4-M10P	1/4	M10 x 1	£3.48
MM4-M12P	1/4	M12 x 1.5	£1.78
MM4-M14P	1/4	M14 x 1.5	£1.78
MM4-M16P	1/4	M16 x 1.5	£1.96
MM4-M18P	1/4	M18 x 1.5	£4.09
MM4-M22P	1/4	M22 x 1.5	£4.35
MM6-M12P	3/8	M12 x 1.5	£3.71
MM6-M14P	3/8	M14 x 1.5	£2.84
MM6-M16P	3/8	M16 x 1.5	£2.84
MM6-M18P	3/8	M18 x 1.5	£2.02
MM6-M20P	3/8	M20 x 1.5	£4.48
MM6-M22P	3/8	M22 x 1.5	£4.48
MM8-M14P	1/2	M14 x 1.5	£4.28
MM8-M16P	1/2	M16 x 1.5	£2.34
MM8-M18P	1/2	M18 x 1.5	£2.34
MM8-M20P	1/2	M20 x 1.5	£3.16
MM8-M22P	1/2	M22 x 1.5	£2.52
MM8-M24P	1/2	M24 x 1.5	£5.03
MM8-M26P	1/2	M26 x 1.5	£5.03
MM10-M22P	5/8	M22 x 1.5	£5.03
MM12-M18P	3/4	M18 x 1.5	£5.03
MM12-M22P	3/4	M22 x 1.5	£5.03
MM12-M24P	3/4	M24 x 1.5	£5.66
MM12-M26P	3/4	M26 x 1.5	£5.03
MM16-M26P	1	M26 x 1.5	£9.54
MM16-M30P	1	M30 x 1.5	£9.75
MM20-M30P	1 1/4	M30 x 1.5	£19.77

Male Adaptor

BSP to NPT
60° Cone



Part No.	BSP	NPT	Price
MM2PN	1/8	1/8	£2.22
MM2P4N	1/8	1/4	£3.65
MM2P6N	1/8	3/8	£3.65
MM4P2N	1/4	1/8	£2.52
MM4P4N	1/4	1/4	£1.40
MM4P6N	1/4	3/8	£2.84
MM4P8N	1/4	1/2	£3.48
MM6P2N	3/8	1/8	£3.22
MM6P4N	3/8	1/4	£2.90
MM6P6N	3/8	3/8	£1.84
MM6P8N	3/8	1/2	£2.96
MM6P12N	3/8	3/4	£5.98
MM8P2N	1/2	1/8	£4.73
MM8P4N	1/2	1/4	£3.65
MM8P6N	1/2	3/8	£3.65
MM8P8N	1/2	1/2	£2.22
MM8P12N	1/2	3/4	£5.28
MM12P4N	3/4	1/4	£5.98
MM12P6N	3/4	3/8	£5.73
MM12P8N	3/4	1/2	£4.73
MM12PN	3/4	3/4	£3.48
MM12P16N	3/4	1	£8.49
MM16P12N	1	3/4	£8.49
MM16PN	1	1	£6.23
MM16P20N	1	1 1/4	£17.27
MM20P16N	1 1/4	1	£17.64
MM20PN	1 1/4	1 1/4	£15.38
MM24P20N	1 1/2	1 1/4	£20.41
MM24PN	1 1/2	1 1/2	£21.72
MM32P24N	2	1 1/2	£36.52
MM32PN	2	2	£32.00

Blanking Plugs

Female Swivel Cap

BSP
60° Cone



Part No.	BSP	Price
BP2PC	1/8	£1.02
BP4PC	1/4	£0.96
BP6PC	3/8	£1.09
BP8PC	1/2	£1.40
BP10PC	5/8	£2.96
BP12PC	3/4	£2.22
BP16PC	1	£3.53
BP20PC	1 1/4	£7.53
BP24PC	1 1/2	£9.87
BP32PC	2	£18.77

Blanking Plug

Solid

BSP



Part No.	BSP	Price
BP2PS	1/8	£1.09
BP4PS	1/4	£1.14
BP6PS	3/8	£1.47
BP8PS	1/2	£1.59
BP10PS	5/8	£3.27
BP12PS	3/4	£2.52
BP16PS	1	£3.77
BP20PS	1 1/4	£11.30
BP24PS	1 1/2	£15.76
BP32PS	2	£24.47

Male Adaptor

Metric to Metric
60° Cone



PGC: 283	Thread 1	Thread 2	Price
MM-M10-M10P	M10 x 1	M10 x 1	£3.48
MM-M10-M12P	M10 x 1	M12 x 1.5	£3.71
MM-M12-M12P	M12 x 1.5	M12 x 1.5	£2.71
MM-M12-M14P	M12 x 1.5	M14 x 1.5	£2.71
MM-M12-M16P	M12 x 1.5	M16 x 1.5	£4.09
MM-M12-M18P	M12 x 1.5	M18 x 1.5	£4.73
MM-M14-M14P	M14 x 1.5	M14 x 1.5	£2.71
MM-M14-M16P	M14 x 1.5	M16 x 1.5	£2.78
MM-M14-M18P	M14 x 1.5	M18 x 1.5	£3.97
MM-M14-M20P	M14 x 1.5	M20 x 1.5	£4.73
MM-M14-M22P	M14 x 1.5	M22 x 1.5	£4.73
MM-M16-M16P	M16 x 1.5	M16 x 1.5	£2.78
MM-M16-M18P	M16 x 1.5	M18 x 1.5	£3.09
MM-M16-M20P	M16 x 1.5	M20 x 1.5	£4.22
MM-M16-M22P	M16 x 1.5	M22 x 1.5	£3.40
MM-M16-M26P	M16 x 1.5	M26 x 1.5	£4.97
MM-M18-M18P	M18 x 1.5	M18 x 1.5	£3.09
MM-M18-M20P	M18 x 1.5	M20 x 1.5	£4.22
MM-M18-M22P	M18 x 1.5	M22 x 1.5	£3.48
MM-M18-M26P	M18 x 1.5	M26 x 1.5	£4.97
MM-M20-M20P	M20 x 1.5	M20 x 1.5	£4.16
MM-M20-M22P	M20 x 1.5	M22 x 1.5	£4.16
MM-M20-M24P	M20 x 1.5	M24 x 1.5	£5.78
MM-M22-M22P	M22 x 1.5	M22 x 1.5	£3.48
MM-M22-M24P	M22 x 1.5	M24 x 1.5	£4.97
MM-M22-M26P	M22 x 1.5	M26 x 1.5	£3.85
MM-M24-M24P	M24 x 1.5	M24 x 1.5	£4.97
MM-M26-M26P	M26 x 1.5	M26 x 1.5	£3.85
MM-M30-M30P	M30 x 1.5	M30 x 1.5	£7.48

Male Adaptor

BSPT to BSPT



Part No.	BSPT 1	BSPT 2	Price
MM2T	1/8	1/8	£2.71
MM4-2T	1/4	1/8	£5.66
MM4T	1/4	1/4	£2.60
MM6-2T	3/8	1/8	£2.60
MM6-4T	3/8	1/4	£3.91
MM6T	3/8	3/8	£2.71
MM8-6T	1/2	3/8	£4.28
MM8T	1/2	1/2	£3.03
MM12-8T	3/4	1/2	£7.24
MM12T	3/4	3/4	£4.65
MM16-12T	1	3/4	£11.30
MM16T	1	1	£5.73
MM20T	1 1/4	1 1/4	£13.76
MM24T	1 1/2	1 1/2	£29.18
MM32T	2	2	£47.37

Blanking Plug

BSPT



Part No.	BSPT	Price
HP2T	1/8	£1.09
HP4T	1/4	£1.14
HP6T	3/8	£1.52
HP8T	1/2	£1.59
HP10T	5/8	£3.40
HP12T	3/4	£2.60
HP16T	1	£3.91
HP20T	1 1/4	£2.60
HP24T	1 1/2	£12.24
HP32T	2	£20.58

Locknuts

Locknut

BSP



Part No.	BSP	Price
LN2HP	1/8	£1.14
LN4HP	1/4	£0.90
LN6HP	3/8	£0.96
LN8HP	1/2	£1.14
LN10HP	5/8	£1.90
LN12HP	3/4	£1.47
LN16HP	1	£2.60
LN20HP	1 1/4	£6.92
LN24HP	1 1/2	£7.86
LN32HP	2	£15.38

Female Caps

Female Swivel Cap

BSPP
60° Cone



PGC: 283	BSPP	Price
CAP2FS	1/8	£2.90
CAP4FS	1/4	£1.47
CAP6FS	3/8	£1.52
CAP8FS	1/2	£1.96
CAP10FS	5/8	£3.85
CAP12FS	3/4	£3.48
CAP16FS	1	£5.47
CAP20FS	1 1/4	£9.11
CAP24FS	1 1/2	£16.01
CAP32FS	2	£31.70

Female Swivel Cap

Metric
60° Cone



PGC: 283	Thread	Price
CAPM12FS	M12 x 1.5	£2.47
CAPM14FS	M14 x 1.5	£2.78
CAPM16FS	M16 x 1.5	£3.09
CAPM18FS	M18 x 1.5	£4.09
CAPM20FS	M20 x 1.5	£4.78
CAPM22FS	M22 x 1.5	£5.35

Female Elbows

Swivel Female Elbow Swept 45°

BSPP
60° Cone



PGC: 283	BSPP	Price
E4FS45	1/4	£8.41
E6FS45	3/8	£10.18
E8FS45	1/2	£12.44
E10FS45	5/8	£16.89
E12FS45	3/4	£19.33
E16FS45	1	£30.87
E20FS45	1 1/4	£48.37
E24FS45	1 1/2	£115.97
E32FS45	2	£168.21

Swivel Female Elbow Swept 90°

BSPP
60° Cone



PGC: 283	BSPP	Price
E4FS	1/4	£8.41
E6FS	3/8	£10.18
E8FS	1/2	£12.44
E10FS	5/8	£16.89
E12FS	3/4	£19.33
E16FS	1	£30.87
E20FS	1 1/4	£48.37
E24FS	1 1/2	£115.97
E32FS	2	£168.21

Swivel Female Elbow Compact 90°

BSPP
60° Cone



PGC: 283	BSPP	Price
E2FC	1/8	£7.86
E4FC	1/4	£4.73
E6FC	3/8	£5.85
E8FC	1/2	£6.92
E10FC	5/8	£18.65
E12FC	3/4	£11.30
E16FC	1	£15.14
E20FC	1 1/4	£37.58
E24FC	1 1/2	£68.69

Fixed Female Elbow 90°

BSPP



PGC: 283	BSPP	Price
E2F	1/8	£7.24
E4F	1/4	£4.60
E6F	3/8	£5.98
E8F	1/2	£7.48
E12F	3/4	£10.62
E16F	1	£15.01

Male Elbows

Male Elbow Compact 90°

BSPP
60° Cone



PGC: 283	BSPP	Price
E2MC	1/8	£9.49
E4MC	1/4	£3.77
E6MC	3/8	£5.35
E8MC	1/2	£5.78
E10MC	5/8	£16.01
E12MC	3/4	£9.23
E16MC	1	£13.93
E20MC	1 1/4	£53.27

Male Elbow Compact 90°

BSPP to BSPT
60° Cone



PGC: 283	BSPP	BSPT	Price
E2PTMC	1/8	1/8	£7.30
E4PTMC	1/4	1/4	£7.30
E6PTMC	3/8	3/8	£8.36
E8PTMC	1/2	1/2	£9.87
E12PTMC	3/4	3/4	£14.68
E16PTMC	1	1	£21.34

Male Adjustable Elbow Compact 90°

BSPP to SAE
60° Cone



PGC: 283	BSPP	SAE	Price
E4-7/16SAE-MC-ADJ	1/4	7/16	£18.28
E4-9/16SAE-MC-ADJ	1/4	9/16	£18.28
E6-9/16SAE-MC-ADJ	3/8	9/16	£21.95
E6-3/4SAE-MC-ADJ	3/8	3/4	£26.98
E6-7/8SAE-MC-ADJ	3/8	7/8	£29.31
E8-3/4SAE-MC-ADJ	1/2	3/4	£26.86
E8-7/8SAE-MC-ADJ	1/2	7/8	£27.42
E10-3/4-MC-ADJ	5/8	3/4	£31.70
E10-7/8-MC-ADJ	5/8	7/8	£31.70
E10-11/16-MC-ADJ	5/8	11/16	£34.32
E12-3/4SAE-MC-ADJ	3/4	3/4	£39.34
E12-7/8SAE-MC-ADJ	3/4	7/8	£30.81
E12-15/16SAE-MC-ADJ	3/4	15/16	£50.18
E16-11/16SAE-MC-ADJ	1	11/16	£49.68
E16-15/16SAE-MC-ADJ	1	15/16	£50.68
E20-1-5/8SAE-MC-ADJ	1 1/4	1 5/8	£88.88

Male Adjustable Elbow Compact 90°
BSPP
60° Cone



PGC: 283	BSPP 1	BSPP 2	Price
E2MC-ADJ	1/8	1/8	£24.10
E2-4MC-ADJ	1/8	1/4	£36.70
E4-2MC-ADJ	1/4	1/8	£24.10
E4MC-ADJ	1/4	1/4	£7.86
E4-6MC-ADJ	1/4	3/8	£12.06
E4-8MC-ADJ	1/4	1/2	£26.30
E6MC-ADJ	3/8	3/8	£8.79
E6-8MC-ADJ	3/8	1/2	£12.24
E8-6MC-ADJ	1/2	3/8	£12.24
E8MC-ADJ	1/2	1/2	£10.68
E8-12MC-ADJ	1/2	3/4	£18.21
E10MC-ADJ	5/8	5/8	£39.22
E12-8MC-ADJ	3/4	1/2	£32.06
E12MC-ADJ	3/4	3/4	£14.75
E12-16MC-ADJ	3/4	1	£48.25
E16-12MC-ADJ	1	3/4	£53.64
E16MC-ADJ	1	1	£19.90
E20MC-ADJ	1 1/4	1 1/4	£35.70
E24MC-ADJ	1 1/2	1 1/2	£55.70

Male Female Elbows

Swivel Male Female Elbow Compact 90°
BSPP
60° Cone



PGC: 283	BSPP 1	BSPP 2	Price
E4-4MFC	1/4	1/4	£3.77
E6-2MFC	3/8	1/8	£7.74
E6-6MFC	3/8	3/8	£4.97
E6-8MFC	3/8	1/2	£8.74
E8-6MFC	1/2	3/8	£8.74
E8-8MFC	1/2	1/2	£5.66
E12-12MFC	3/4	3/4	£9.11
E16-16MFC	1	1	£14.45
E20-20MFC	1 1/4	1 1/4	£27.11
E24-24MFC	1 1/2	1 1/2	£43.90
E32-32MFC	2	2	£101.60

Swivel Male Female Elbow Swept 90°
BSPP
60° Cone



PGC: 283	BSPP	Price
E4MFS	1/4	£7.41
E6MFS	3/8	£8.23
E8MFS	1/2	£10.37
E10MFS	5/8	£18.33
E12MFS	3/4	£17.07
E16MFS	1	£26.92
E20MFS	1 1/4	£48.37
E24MFS	1 1/2	£115.97
E32MFS	2	£168.21

Male Adjustable Elbow Compact 45°
BSPP
60° Cone



• Supplied complete with O-ring and retaining ring

PGC: 283	BSPP	Price
E2MC45-ADJ	1/8	£9.42
E4MC45-ADJ	1/4	£8.11
E6MC45-ADJ	3/8	£9.11
E8MC45-ADJ	1/2	£11.62
E12MC45-ADJ	3/4	£15.44
E16MC45-ADJ	1	£23.54
E20MC45-ADJ	1 1/4	£94.40

Swivel Male Female Elbow Compact 45°
BSPP
60° Cone



PGC: 283	BSPP	Price
E4MFC45	1/4	£4.40
E6MFC45	3/8	£5.47
E8MFC45	1/2	£5.98
E10MFC45	5/8	£23.85
E12MFC45	3/4	£8.79
E16MFC45	1	£17.27
E20MFC45	1 1/4	£37.76
E24MFC45	1 1/2	£68.24
E32MFC45	2	£238.65

Swivel Male Female Elbow Compact 90°
BSPP
60° Cone



• To suit bonded washer

PGC: 283	BSPP	Price
E2MFC	1/8	£5.98
E4MFC	1/4	£5.98
E6MFC	3/8	£5.35
E8MFC	1/2	£6.66
E12MFC	3/4	£12.62
E16MFC	1	£18.45

Swivel Male Female Elbow Swept 45°
BSPP
60° Cone



PGC: 283	BSPP	Price
E4MFS45	1/4	£8.41
E6MFS45	3/8	£10.18
E8MFS45	1/2	£12.44
E10MFS45	5/8	£16.89
E12MFS45	3/4	£19.33
E16MFS45	1	£30.87
E20MFS45	1 1/4	£48.37
E24MFS45	1 1/2	£115.97
E32MFS45	2	£168.21

Female Tees

Fixed Female Compact Tee
BSPP



PGC: 283	BSPP	Price
T2F	1/8	£5.03
T4F	1/4	£5.17
T6F	3/8	£6.92
T8F	1/2	£8.92
T12F	3/4	£12.55
T16F	1	£17.27

Male Tees

Male Tee

BSP
60° Cone



PGC: 283	BSP	Price
T2M	1/8	£7.79
T4M	1/4	£5.10
T6M	3/8	£6.23
T8M	1/2	£8.05
T10M	5/8	£15.06
T12M	3/4	£10.80
T16M	1	£14.06
T20M	1 1/4	£56.57
T24M	1 1/2	£166.53

Swivel Tees

Swivel Female Tee

BSP
60° Cone



PGC: 283	BSP	Price
T2S	1/8	£8.30
T4S	1/4	£7.67
T6S	3/8	£8.49
T8S	1/2	£10.30
T10S	5/8	£19.52
T12S	3/4	£15.94
T16S	1	£21.03
T20S	1 1/4	£55.14
T24S	1 1/2	£73.08

Female Swivel Male Female Swivel Tee

BSP
60° Cone



PGC: 283	BSP 1	BSP 2	BSP 3	Price
T4S-4M-4S	1/4	1/4	1/4	£10.80
T6S-6M-6S	3/8	3/8	3/8	£11.88
T8S-8M-8S	1/2	1/2	1/2	£15.38
T12S-12M-12S	3/4	3/4	3/4	£24.17
T16S-16M-16S	1	1	1	£29.43

Adjustable Tees

Male Adjustable Branch Tee

BSP
60° Cone



PGC: 283	BSP	Price
T4M-B-ADJ	1/4	£14.14
T6M-B-ADJ	3/8	£16.32
T8M-B-ADJ	1/2	£18.14
T12M-B-ADJ	3/4	£20.41
T16M-B-ADJ	1	£32.00

Male Male Female Swivel Tee

BSP
60° Cone



PGC: 283	BSP 1	BSP 2	BSP 3	Price
T2M-2M-2S	1/8	1/8	1/8	£8.74
T4M-4M-4S	1/4	1/4	1/4	£5.85
T6M-6M-6S	3/8	3/8	3/8	£6.41
T8M-8M-8S	1/2	1/2	1/2	£9.05
T10M-10M-10S	5/8	5/8	5/8	£19.46
T12M-12M-12S	3/4	3/4	3/4	£14.38
T16M-16M-16S	1	1	1	£20.20
T20M-20S-20S	1 1/4	1 1/4	1 1/4	£56.57
T24M-20S-20S	1 1/2	1 1/2	1 1/2	£82.92

Female Swivel Female Swivel Male Tee

BSP
60° Cone



PGC: 283	BSP 1	BSP 2	BSP 3	Price
T4S-4S-4M	1/4	1/4	1/4	£8.86
T6S-6S-6M	3/8	3/8	3/8	£10.18
T8S-8S-8M	1/2	1/2	1/2	£12.00
T12S-12S-12M	3/4	3/4	3/4	£18.71
T16S-16S-16M	1	1	1	£26.04

Male Adjustable Run Tee

BSP
60° Cone



PGC: 283	BSP	Price
T4M-R-ADJ	1/4	£14.14
T6M-R-ADJ	3/8	£16.32
T8M-R-ADJ	1/2	£18.14
T12M-R-ADJ	3/4	£20.41
T16M-R-ADJ	1	£32.00

Male Female Swivel Male Tee

BSP
60° Cone



PGC: 283	BSP 1	BSP 2	BSP 3	Price
T2M-2S-2M	1/8	1/8	1/8	£11.01
T4M-4S-4M	1/4	1/4	1/4	£5.85
T6M-6S-6M	3/8	3/8	3/8	£6.41
T8M-8S-8M	1/2	1/2	1/2	£9.05
T10M-10S-10M	5/8	5/8	5/8	£26.35
T12M-12S-12M	3/4	3/4	3/4	£14.38
T16M-16S-16M	1	1	1	£23.21
T20M-20S-20M	1 1/4	1 1/4	1 1/4	£61.17
T24M-20S-20M	1 1/2	1 1/2	1 1/2	£104.18

Bulkheads

Bulkhead

BSP Thread
60° Cone



* Supplied complete with locknut assembled

PGC: 283	BSP 1	BSP 2	Price
BH2HP	1/8	1/8	£6.16
BH4HP	1/4	1/4	£3.53
BH6HP	3/8	3/8	£4.09
BH8-8HP	3/8	1/2	£10.43
BH8-6HP	1/2	3/8	£10.43
BH8HP	1/2	1/2	£4.40
BH10HP	5/8	5/8	£9.23
BH12-8HP	3/4	1/2	£17.64
BH12HP	3/4	3/4	£8.67
BH16HP	1	1	£9.37
BH20HP	1 1/4	1 1/4	£20.20
BH24HP	1 1/2	1 1/2	£35.52
BH32HP	2	2	£50.81

Adaptors

Swivel Male Female Adaptor

BSPP
60° Cone



PGC: 283	BSPP 1	BSPP 2	Price
MF2-2S	1/8	1/8	£2.96
MF2-4S	1/8	1/4	£2.96
MF2-6S	1/8	3/8	£3.48
MF4-2S	1/4	1/8	£2.96
MF4-4S	1/4	1/4	£1.84
MF4-6S	1/4	3/8	£2.22
MF4-8S	1/4	1/2	£4.09
MF4-12S	1/4	3/4	£8.79
MF6-2S	3/8	1/8	£3.71
MF6-4S	3/8	1/4	£2.22
MF6-6S	3/8	3/8	£2.34
MF6-8S	3/8	1/2	£2.78
MF6-12S	3/8	3/4	£7.24
MF8-4S	1/2	1/4	£3.85
MF8-6S	1/2	3/8	£2.78
MF8-8S	1/2	1/2	£3.03
MF8-12S	1/2	3/4	£4.16
MF8-16S	1/2	1	£9.42
MF10-10S	5/8	5/8	£5.10
MF10-12S	5/8	3/4	£8.23
MF12-6S	3/4	3/8	£8.23
MF12-8S	3/4	1/2	£3.95
MF12-12S	3/4	3/4	£4.91
MF12-16S	3/4	1	£6.79
MF12-20S	3/4	1 1/4	£21.46
MF12-24S	3/4	1 1/2	£30.74
MF16-6S	1	3/8	£9.99
MF16-8S	1	1/2	£9.99
MF16-12S	1	3/4	£7.67
MF16-16S	1	1	£7.16
MF16-20S	1	1 1/4	£19.46
MF16-24S	1	1 1/2	£30.06
MF20-8S	1 1/4	1/2	£20.72
MF20-12S	1 1/4	3/4	£19.46
MF20-16S	1 1/4	1	£19.04
MF20-20S	1 1/4	1 1/4	£16.20
MF20-24S	1 1/4	1 1/2	£29.81
MF24-16S	1 1/2	1	£29.81
MF24-20S	1 1/2	1 1/4	£29.81
MF24-24S	1 1/2	1 1/2	£23.73
MF32-24S	2	1 1/2	£51.57
MF32-32S	2	2	£39.65

Fixed Male Female Adaptor

BSPP
60° Cone



PGC: 283	BSPP 1	BSPP 2	Price
MF2-2HPC	1/8	1/8	£3.97
MF2-4HPC	1/8	1/4	£2.65
MF2-6HPC	1/8	3/8	£5.98
MF2-8HPC	1/8	1/2	£9.37
MF4-2HPC	1/4	1/8	£2.84
MF4-4HPC	1/4	1/4	£2.47
MF4-6HPC	1/4	3/8	£2.65
MF4-8HPC	1/4	1/2	£3.65
MF4-12HPC	1/4	3/4	£10.75
MF6-4HPC	3/8	1/4	£2.65
MF6-6HPC	3/8	3/8	£2.65
MF6-8HPC	3/8	1/2	£2.96
MF6-12HPC	3/8	3/4	£11.12
MF8-6HPC	1/2	3/8	£2.96
MF8-8HPC	1/2	1/2	£2.96
MF12-6HPC	3/4	3/8	£6.10
MF12-8HPC	3/4	1/2	£10.80
MF12-12HPC	3/4	3/4	£4.03
MF12-16HPC	3/4	1	£9.24
MF16-8HPC	1	1/2	£10.24
MF16-12HPC	1	3/4	£7.86
MF16-16HPC	1	1	£7.86
MF16-20HPC	1	1 1/4	£35.70
MF16-24HPC	1	1 1/2	£37.58
MF20-20HPC	1 1/4	1 1/4	£20.58
MF24-24HPC	1 1/2	1 1/2	£37.96
MF32-32HPC	2	2	£45.24

Female Sockets

Fixed Female Socket

BSPP

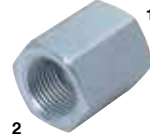

PGC: 283	BSPP 1	BSPP 2	Price
S2FF	1/8	1/8	£1.84
S4-2FF	1/4	1/8	£5.40
S4FF	1/4	1/4	£1.64
S6-4FF	3/8	1/4	£5.78
S6FF	3/8	3/8	£2.02
S8-6FF	1/2	3/8	£6.23
S8FF	1/2	1/2	£2.27
S10FF	5/8	5/8	£10.18
S12-8FF	3/4	1/2	£9.18
S12FF	3/4	3/4	£4.97
S16-12FF	1	3/4	£15.57
S16FF	1	1	£7.61
S20FF	1 1/4	1 1/4	£21.78
S24FF	1 1/2	1 1/2	£35.08
S32FF	2	2	£57.33

Swivel Female Socket

BSPP
60° Cone



PGC: 283	BSPP 1	BSPP 2	Price
S2-2S	1/8	1/8	£2.65
S4-2S	1/4	1/8	£2.84
S4-4S	1/4	1/4	£2.22
S6-4S	3/8	1/4	£2.96
S6-6S	3/8	3/8	£2.60
S8-4S	1/2	1/4	£3.48
S8-6S	1/2	3/8	£3.48
S8-8S	1/2	1/2	£3.71
S10-8S	5/8	1/2	£5.73
S10-10S	5/8	5/8	£5.73
S12-8S	3/4	1/2	£5.47
S12-12S	3/4	3/4	£5.40
S16-12S	1	3/4	£10.37
S16-16S	1	1	£8.67
S20-20S	1 1/4	1 1/4	£18.02
S24-24S	1 1/2	1 1/2	£27.61
S32-32S	2	2	£52.26

Reducing Bushes

Reducing Bush

BSPP



PGC: 283	BSPP 1	BSPP 2	Price
RB6-2HP	3/8	1/8	£2.47
RB6-4HP	3/8	1/4	£2.47
RB8-2HP	1/2	1/8	£4.53
RB8-4HP	1/2	1/4	£2.52
RB8-6HP	1/2	3/8	£2.52
RB12-4HP	3/4	1/4	£5.10
RB12-6HP	3/4	3/8	£3.65
RB12-8HP	3/4	1/2	£3.65
RB16-4HP	1	1/4	£6.41
RB16-6HP	1	3/8	£6.41
RB16-8HP	1	1/2	£6.41
RB20-8HP	1 1/4	1/2	£15.14
RB20-12HP	1 1/4	3/4	£15.14
RB20-16HP	1 1/4	1	£15.14
RB24-8HP	1 1/2	1/2	£34.83
RB24-12HP	1 1/2	3/4	£34.83
RB24-16HP	1 1/2	1	£34.83
RB32-16HP	2	1	£44.22
RB32-20HP	2	1 1/4	£44.22
RB32-24HP	2	1 1/2	£44.22



JIC Adaptors

37 Series Adaptor Range

The Vale® range of Flare JIC fittings is ideal for arduous duties. Conforming to the SAE J 514 standard, all the elbows, tees and crosses are produced from forgings, eliminating the potential leak path of brazed components.

The 37 Series is ideal for metric or imperial tubing by changing the free-floating sleeve to suit the application, thus providing a permanent leakproof seal which can be re-assembled repeatedly. The product performs very well under severe vibration and any pressure peaks.

- Manufactured to SAE J514 Standard
- Trivalent passivate surface plating for ELVD (2000/53/EC) compliancy
- Male threads are capped for full protection

Surface Plating

All fittings are coated with trivalent passivate which achieves a blue/silver colour. The salt spray resistance of the trivalent is 72-90 hours to first white corrosion. The trivalent passivate used is more environmentally acceptable and is in keeping with the End of Life Vehicle Directive (2000/53/EC).



Thread Protection

All our 37 Series JIC adaptor range is capped on all male threads for full protection.



Working Pressure:
Up to 345 bar (5000 psi)

Torque Chart

JIC Thread Size	Torque (Nm)
7/16-20	15
1/2-20	20
9/16-18	30
3/4-16	60
7/8-14	75
1 1/16-12	110
1 3/16-12	135
1 5/16-12	155
1 5/8-12	215
1 7/8-12	250
2 1/2-12	340

⚠ Torque values of components may vary during installation. Factors contributing to this are different types of manufacture forging / braze construction, plating and tolerances of male and female threads.

JIC to JIC

Adaptors

Unions

Female Swivel Union

Female Thread JIC



PGC: 283	JIC 1	JIC 2	Price
S4-4SJ	7/16-20	7/16-20	£5.35
S5-5SJ	1/2-20	1/2-20	£5.35
S6-4SJ	9/16-18	7/16-20	£5.35
S6-5SJ	9/16-18	1/2-20	£5.35
S6-6SJ	9/16-18	9/16-18	£5.35
S8-6SJ	3/4-16	9/16-18	£5.66
S8-8SJ	3/4-16	3/4-16	£5.66
S10-6SJ	7/8-14	9/16-18	£6.92
S10-8SJ	7/8-14	3/4-16	£6.92
S10-10SJ	7/8-14	7/8-14	£6.92
S12-12SJ	1 1/16-12	1 1/16-12	£13.19
S14-14SJ	1 3/16-12	1 3/16-12	£15.06
S16-12SJ	1 5/16-12	1 1/16-12	£16.64
S16-16SJ	1 5/16-12	1 5/16-12	£16.64
S20-20SJ	1 5/8-12	1 5/8-12	£33.88
S24-24SJ	1 7/8-12	1 7/8-12	£43.90

Male Adaptor

Male Thread JIC



PGC: 283	JIC 1	JIC 2	Price
MM4-4J	7/16-20	7/16-20	£1.64
MM5-4J	1/2-20	7/16-20	£2.34
MM5-5J	1/2-20	1/2-20	£1.78
MM6-4J	9/16-18	7/16-20	£2.34
MM6-5J	9/16-18	1/2-20	£2.34
MM6-6J	9/16-18	9/16-18	£1.71
MM8-4J	3/4-16	7/16-20	£3.15
MM8-5J	3/4-16	1/2-20	£3.15
MM8-6J	3/4-16	9/16-18	£2.71
MM8-8J	3/4-16	3/4-16	£2.34
MM10-4J	7/8-14	7/16-20	£4.48
MM10-6J	7/8-14	9/16-18	£3.15
MM10-8J	7/8-14	3/4-16	£2.78
MM10-10J	7/8-14	7/8-14	£2.60
MM12-5J	1 1/16-12	1/2-20	£6.98
MM12-6J	1 1/16-12	9/16-18	£5.78
MM12-8J	1 1/16-12	3/4-16	£4.73
MM12-10J	1 1/16-12	7/8-14	£3.85
MM12-12J	1 1/16-12	1 1/16-12	£3.65
MM14-14J	1 3/16-12	1 1/16-12	£7.24
MM14-12J	1 3/16-12	1 3/16-12	£5.35
MM16-10J	1 5/16-12	7/8-14	£6.85
MM16-12J	1 5/16-12	1 1/16-12	£5.23
MM16-16J	1 5/16-12	1 5/16-12	£5.23
MM20-20J	1 5/8-12	1 5/8-12	£11.12
MM24-20J	1 7/8-12	1 7/8-12	£18.33
MM24-24J	1 7/8-12	1 5/8-12	£15.69
MM32-32J	2 1/2-12	2 1/2-12	£37.58

Male Female Adaptor

Male Thread JIC

Female Thread JIC



PGC: 283	JIC 1	JIC 2	Price
MF4-4J	7/16-20	7/16-12	£4.09
MF4-6J	7/16-20	9/16-12	£4.09
MF5-5J	1/2-20	1/2-20	£4.09
MF5-6J	1/2-20	9/16-18	£4.09
MF6-4J	9/16-18	7/16-20	£4.09
MF6-6J	9/16-18	9/16-18	£4.09
MF6-8J	9/16-18	3/4-16	£4.40
MF8-6J	3/4-16	9/16-18	£4.40
MF8-8J	3/4-16	3/4-16	£4.40
MF8-10J	3/4-16	7/8-14	£4.73
MF8-12J	3/4-16	1 1/16-12	£7.24
MF10-8J	7/8-14	3/4-16	£4.73
MF10-10J	7/8-14	7/8-14	£4.73
MF10-12J	7/8-14	1 1/16-12	£7.24
MF12-8J	1 1/16-12	3/4-16	£6.28
MF12-10J	1 1/16-12	7/8-14	£6.28
MF12-12J	1 1/16-12	1 1/16-12	£6.92
MF16-12J	1 5/16-12	1 1/16-12	£11.62
MF16-16J	1 5/16-12	1 5/16-12	£11.62
MF20-20J	1 5/8-12	1 5/8-12	£28.56
MF24-24J	1 7/8-12	1 7/8-12	£41.72

Tees

Male Union Tee

Male Thread JIC



PGC: 283	JIC	Price
T4MJ	7/16-20	£4.09
T5MJ	1/2-20	£6.92
T6MJ	9/16-18	£4.22
T8MJ	3/4-16	£5.35
T10MJ	7/8-14	£6.28
T12MJ	1 1/16-12	£9.49
T14MJ	1 3/16-12	£21.95
T16MJ	1 5/16-12	£12.55
T20MJ	1 5/8-12	£50.51
T24MJ	1 7/8-12	£62.92
T32MJ	2 1/2-12	£169.03

Female Swivel Run Tee

Female Thread JIC



PGC: 283	JIC	Price
T4FJ-RT	7/16-20	£5.91
T5FJ-RT	1/2-20	£9.11
T6FJ-RT	9/16-18	£6.61
T8FJ-RT	3/4-16	£7.30
T10FJ-RT	7/8-14	£9.05
T12FJ-RT	1 1/16-12	£14.31
T14FJ-RT	1 3/16-12	£103.49
T16FJ-RT	1 5/16-12	£19.59
T20FJ-RT	1 5/8-12	£83.42
T24FJ-RT	1 7/8-12	£108.00
T32FJ-RT	2 1/2-12	£250.74

Female Swivel Branch Tee

Female Thread JIC



PGC: 283	JIC	Price
T4FJ-BT	7/16-20	£5.91
T5FJ-BT	1/2-20	£9.11
T6FJ-BT	9/16-18	£6.61
T8FJ-BT	3/4-16	£7.30
T10FJ-BT	7/8-14	£9.05
T12FJ-BT	1 1/16-12	£14.31
T14FJ-BT	1 3/16-12	£113.52
T16FJ-BT	1 5/16-12	£19.59
T20FJ-BT	1 5/8-12	£83.42
T24FJ-BT	1 7/8-12	£108.00
T32FJ-BT	2 1/2-12	£250.74

Female Swivel Tee

Female Thread JIC



PGC: 283	JIC	Price
T4SJ	7/16-20	£10.05
T5SJ	1/2-20	£10.54
T6SJ	9/16- 8	£19.21
T8SJ	3/4-16	£11.62
T10SJ	7/8-14	£15.57
T12SJ	1 1/16-12	£25.66
T16SJ	1 5/16-12	£37.71

Male Elbows

Male Compact Elbow 90°

Male Thread JIC



PGC: 283	JIC 1	JIC 2	Price
E4MCJ	7/16-20	7/16-20	£4.78
E5MCJ	1/2-20	1/2-20	£4.78
E6MCJ	9/16-18	9/16-18	£5.10
E8MCJ	3/4-16	3/4-16	£7.24
E10-8MCJ	7/8-14	3/4-16	£7.67
E10MCJ	7/8-14	7/8-14	£18.51
E12-8MCJ	1 1/16-12	3/4-16	£9.75
E12MCJ	1 1/16-12	1 1/16-12	£22.28
E14MCJ	1 3/16-12	1 3/16-12	£16.95
E16MCJ	1 5/16-12	1 5/16-12	£18.28
E20MCJ	1 5/8-12	1 5/8-12	£37.14
E24MCJ	1 7/8-12	1 7/8-12	£59.22
E32MCJ	2 1/2-12	2 1/2-12	£312.95

Female Elbows

Male Female Compact Swivel Elbow 90°

Male Thread JIC
Female Thread JIC



PGC: 283	JIC	Price
E4MFCJ	7/16-20	£5.61
E5MFCJ	1/2-20	£6.98
E6MFCJ	9/16-18	£5.67
E8MFCJ	3/4-16	£6.61
E10MFCJ	7/8-14	£8.67
E12MFCJ	1 1/16-12	£13.25
E14MFCJ	1 3/16-12	£27.61
E16MFCJ	1 5/16-12	£19.52
E20MFCJ	1 5/8-12	£40.40
E24MFCJ	1 7/8-12	£73.64
E32MFCJ	2 1/2-12	£179.50

Female Swivel Compact Elbow 90°

Female Thread JIC



PGC: 283	JIC	Price
E4FCJ	7/16-20	£7.61
E5FCJ	1/2-20	£7.86
E6FCJ	9/16-18	£8.23
E8FCJ	3/4-16	£10.62
E10FCJ	7/8-14	£13.50
E12FCJ	1 1/16-12	£17.20
E14FCJ	1 3/16-12	£25.80
E16FCJ	1 5/16-12	£31.49
E20FCJ	1 5/8-12	£40.23
E24FCJ	1 7/8-12	£87.94

Male Female Swivel Elbows

Male Female Swivel Compact Elbow 45°

Male Thread JIC
Female Thread JIC



PGC: 283	JIC	Price
E4MFCJ45	7/16-20	£6.28
E5MFCJ45	1/2-20	£7.67
E6MFCJ45	9/16-18	£5.98
E8MFCJ45	3/4-16	£6.61
E10MFCJ45	7/8-14	£9.42
E12MFCJ45	1 1/16-12	£14.31
E16MFCJ45	1 5/16-12	£25.10
E20MFCJ45	1 5/8-12	£56.78
E24MFCJ45	1 7/8-12	£76.52
E32MFCJ45	2 1/2-12	£230.80

Crosses

Male Equal Cross

Male Thread JIC



PGC: 283	JIC	Price
X4MJ	7/16-20	£12.39
X6MJ	9/16-18	£12.84
X8MJ	3/4-16	£14.61
X10MJ	7/8-14	£17.63
X12MJ	1 1/16-12	£27.56
X16MJ	1 5/16-12	£46.19
X20MJ	1 5/8-12	£91.80
X24MJ	1 7/8-12	£178.63

JIC Bulkheads

02

Male Bulkhead Adaptors

Male Bulkhead Adaptor

Complete with Locknut
Male Thread JIC



PGC: 283	JIC	Price
BH4HPJ	7/16-20	£4.53
BH5HPJ	1/2-20	£8.11
BH6HPJ	9/16-18	£4.53
BH8HPJ	3/4-16	£4.91
BH10HPJ	7/8-14	£6.61
BH12HPJ	1 1/16-12	£10.49
BH14HPJ	1 3/16-12	£28.18
BH16HPJ	1 5/16-12	£16.76
BH20HPJ	1 5/8-12	£39.22
BH24HPJ	1 7/8-12	£67.44

Male Bulkhead Adaptor

Complete with Locknut
Male Thread JIC to NPT



PGC: 283	JIC	NPT	Price
BH4J-4N	7/16-20	1/4	£17.20
BH6J-6N	9/16-18	3/8	£13.63
BH8J-8N	3/4-16	1/2	£17.70
BH10J-8N	7/8-14	1/2	£20.08
BH12J-12N	1 1/16-12	3/4	£20.65
BH16J-16N	1 5/16-12	1	£26.98
BH20J-20N	1 5/8-12	1 1/4	£74.64
BH24J-24N	1 7/8-12	1 1/2	£165.76

Male Bulkhead Branch Tees

Male Bulkhead Branch Tee

Complete with Locknut
Male Thread JIC



PGC: 283	JIC	Price
BHBT4HPJ	7/16-20	£25.43
BHBT5HPJ	1/2-20	£31.06
BHBT6HPJ	9/16-18	£27.61
BHBT8HPJ	3/4-16	£29.81
BHBT10HPJ	7/8-14	£42.41
BHBT12HPJ	1 1/16-12	£50.81
BHBT16HPJ	1 5/16-12	£72.46

Male Bulkhead Run Tees

Male Bulkhead Run Tee

Complete with Locknut
Male Thread JIC



PGC: 283	JIC	Price
BHRT4HPJ	7/16-20	£25.43
BHRT6HPJ	9/16-18	£27.61
BHRT8HPJ	3/4-16	£29.81
BHRT10HPJ	7/8-14	£42.41
BHRT12HPJ	1 1/16-12	£50.81
BHRT16HPJ	1 5/16-12	£72.46

Male Bulkhead Elbows

Male Bulkhead Elbow 45°

Complete with Locknut
Male Thread JIC



PGC: 283	JIC	Price
BHE4-45HPJ	7/16-20	£14.14
BHE5-45HPJ	1/2-20	£22.91
BHE6-45HPJ	9/16-18	£26.35
BHE8-45HPJ	3/4-16	£32.63
BHE10-45HPJ	7/8-14	£46.42
BHE12-45HPJ	1 1/16-12	£53.01
BHE16-45HPJ	1 5/16-12	£94.71

Male Bulkhead Elbow 90°

Complete with Locknut
Male Thread JIC



PGC: 283	JIC	Price
BHE4HPJ	7/16-20	£10.05
BHE5HPJ	1/2-20	£13.19
BHE6HPJ	9/16-18	£12.62
BHE8HPJ	3/4-16	£13.50
BHE10HPJ	7/8-14	£21.66
BHE12HPJ	1 1/16-12	£31.12
BHE16HPJ	1 5/16-12	£42.15
BHE20HPJ	1 5/8-12	£76.52
BHE24HPJ	1 7/8-12	£266.86

NPT Bulkheads

Male Female Bulkheads

Male Female Bulkhead NPT

Male Thread JIC
Female Thread NPT



PGC: 283	JIC	NPT	Price
FBH4MJ-2N	7/16-20	1/8	£11.12
FBH6MJ-4N	9/16-18	1/4	£23.85
FBH6MJ-6N	9/16-18	3/8	£24.47
FBH8MJ-6N	3/4-16	3/8	£22.59
FBH8MJ-8N	3/4-16	1/2	£22.59
FBH10MJ-8N	7/8-14	1/2	£24.72
FBH12MJ-12N	1 1/16-12	3/4	£30.62
FBH16MJ-16N	1 5/16-12	1	£39.14
FBH20MJ-20N	1 5/8-12	1 1/4	£174.35

JIC to NPT

Adaptors

Male Female Swivel Adaptor

Male Thread NPT
Female Thread JIC



PGC: 283	JIC	NPT	Price
MF4J-2N	7/16-20	1/8	£3.85
MF4J-4N	7/16-20	1/4	£5.35
MF4J-6N	7/16-20	3/8	£5.54
MF5J-4N	1/2-20	1/4	£9.11
MF6J-4N	9/16-18	1/4	£3.48
MF6J-6N	9/16-18	3/8	£4.12
MF8J-4N	3/4-16	1/4	£15.38
MF8J-6N	3/4-16	3/8	£3.48
MF8J-8N	3/4-16	1/2	£8.49
MF10J-6N	7/8-14	3/8	£17.58
MF10J-8N	7/8-14	1/2	£4.85
MF12J-8N	1 1/16-12	1/2	£19.15
MF12J-12N	1 1/16-12	3/4	£7.04
MF16J-16N	1 5/16-12	1	£8.11
MF20J-20N	1 5/8-12	1 1/4	£53.01
MF24J-24N	1 7/8-12	1 1/2	£113.52

Male Female Fixed Reducing Adaptor

Male Thread JIC
Female Thread NPT



PGC: 283	JIC	NPT	Price
MF4MJ-2NF	7/16-20	1/8	£7.53
MF4MJ-4NF	7/16-20	1/4	£6.36
MF4MJ-6NF	7/16-20	3/8	£14.75
MF5MJ-2NF	1/2-20	1/8	£17.27
MF5MJ-4NF	1/2-20	1/4	£17.27
MF6MJ-4NF	9/16-18	1/4	£4.73
MF6MJ-6NF	9/16-18	3/8	£4.40
MF6MJ-8NF	9/16-18	1/2	£10.68
MF8MJ-4NF	3/4-16	1/4	£11.44
MF8MJ-6NF	3/4-16	3/8	£6.04
MF8MJ-8NF	3/4-16	1/2	£6.04
MF10MJ-8NF	7/8-14	1/2	£11.06
MF12MJ-8NF	1 1/16-12	1/2	£13.63
MF12MJ-12NF	1 1/16-12	3/4	£12.31
MF16MJ-16NF	1 5/16-12	1	£29.18
MF20MJ-20NF	1 5/8-12	1 1/4	£50.38
MF24MJ-24NF	1 7/8-12	1 1/2	£66.93
MF32MJ-32NF	2 1/2-12	2	£108.51

Male Adaptor

Male Thread JIC
Male Thread NPT



PGC: 283	JIC	NPT	Price
MM4J-2N	7/16-20	1/8	£1.47
MM4J-4N	7/16-20	1/4	£1.52
MM4J-6N	7/16-20	3/8	£2.02
MM4J-8N	7/16-20	1/2	£4.48
MM5J-2N	1/2-20	1/8	£1.47
MM5J-4N	1/2-20	1/4	£1.52
MM5J-6N	1/2-20	3/8	£2.02
MM6J-2N	9/16-18	1/8	£2.39
MM6J-4N	9/16-18	1/4	£1.59
MM6J-6N	9/16-18	3/8	£1.64
MM6J-8N	9/16-18	1/2	£2.39
MM6J-12N	9/16-18	3/4	£4.28
MM8J-4N	3/4-16	1/4	£2.27
MM8J-6N	3/4-16	3/8	£2.02
MM8J-8N	3/4-16	1/2	£2.27
MM8J-12N	3/4-16	3/4	£4.28
MM10J-6N	7/8-14	3/8	£2.39
MM10J-8N	7/8-14	1/2	£2.39
MM10J-12N	7/8-14	3/4	£4.28
MM10J-16N	7/8-14	1	£8.49
MM12J-6N	1 1/16-12	3/8	£4.28
MM12J-8N	1 1/16-12	1/2	£3.85
MM12J-12N	1 1/16-12	3/4	£4.09
MM12J-16N	1 1/16-12	1	£5.66
MM14J-12N	1 3/16-12	3/4	£11.62
MM16J-12N	1 5/16-12	3/4	£5.66
MM16J-16N	1 5/16-12	1	£5.66
MM16J-20N	1 5/16-12	1 1/4	£15.32
MM16J-24N	1 5/16-12	1 1/2	£25.29
MM20J-16N	1 5/8-12	1	£15.32
MM20J-20N	1 5/8-12	1 1/4	£12.55
MM20J-24N	1 5/8-12	1 1/2	£18.07
MM24J-20N	1 7/8-12	1 1/4	£25.29
MM24J-24N	1 7/8-12	1 1/2	£17.64
MM32J-32N	2 1/2-12	2	£38.27

Male Tees

Male Run Tee

Male Thread JIC
Male Thread NPT



PGC: 283	JIC	NPT	Price
T4MJ-2N-RT	7/16-20	1/8	£12.88
T4MJ-4N-RT	7/16-20	1/4	£12.88
T6MJ-4N-RT	9/16-18	1/4	£13.50
T6MJ-6N-RT	9/16-18	3/8	£13.50
T8MJ-6N-RT	3/4-16	3/8	£21.78
T8MJ-8N-RT	3/4-16	1/2	£21.78
T10MJ-8N-RT	7/8-14	1/2	£24.10
T12MJ-12N-RT	1 1/16-12	3/4	£31.12
T16MJ-16N-RT	1 5/16-12	1	£49.63
T20MJ-20N-RT	1 5/8-12	1 1/4	£146.83
T24MJ-24N-RT	1 7/8-12	1 1/2	£187.39
T32MJ-32N-RT	2 1/2-12	2	£388.82

Male Branch Tee

Male Thread JIC
Male Thread NPT



PGC: 283	JIC	NPT	Price
T4MJ-2N-BT	7/16-20	1/8	£12.88
T4MJ-4N-BT	7/16-20	1/4	£12.88
T6MJ-4N-BT	9/16-18	1/4	£13.50
T6MJ-6N-BT	9/16-18	3/8	£13.50
T8MJ-6N-BT	3/4-16	3/8	£21.78
T8MJ-8N-BT	3/4-16	1/2	£21.78
T10MJ-8N-BT	7/8-14	1/2	£24.10
T12MJ-12N-BT	1 1/16-12	3/4	£31.12
T16MJ-16N-BT	1 5/16-12	1	£49.63
T20MJ-20N-BT	1 5/8-12	1 1/4	£146.83
T24MJ-24N-BT	1 7/8-12	1 1/2	£187.39
T32MJ-32N-BT	2 1/2-12	2	£388.82

Female Tees

Fixed Male Female Branch Tee

Male Thread JIC
Female Thread NPT



PGC: 283	JIC	NPT	Price
T4MJ-4MJ-2N	7/16-20	1/8	£30.44
T8MJ-8MJ-6N	3/4-16	3/8	£37.01
T10MJ-10MJ-8N	7/8-14	1/2	£48.30
T12MJ-12MJ-12N	1 1/16-12	3/4	£66.88
T16MJ-16MJ-16N	1 5/16-12	1	£119.79
T20MJ-20MJ-20N	1 5/8-12	1 1/4	£177.11
T24MJ-24MJ-24N	1 7/8-12	1 1/2	£217.31

Male Female Fixed Elbow 90°

Male Thread JIC
Female Thread NPT



PGC: 283	JIC	NPT	Price
E4MJ-2NF	7/16-12	1/8	£13.81
E4MJ-4NF	7/16-12	1/4	£13.81
E6MJ-4NF	9/16-18	1/4	£15.06
E6MJ-6NF	9/16-18	3/8	£15.06
E8MJ-6NF	3/4-16	3/8	£16.64
E8MJ-8NF	3/4-16	1/2	£17.90
E10MJ-8NF	7/8-14	1/2	£23.59
E12MJ-12NF	1 1/16-12	3/4	£28.56
E16MJ-16NF	1 5/16-12	1	£70.58
E20MJ-20NF	1 5/8-12	1 1/4	£100.35

Male Elbows

Male Elbow 45°

Male Thread JIC
Male Thread NPT



PGC: 283	JIC	NPT	Price
E4MJ-2N-45	7/16-20	1/8	£6.04
E4MJ-4N-45	7/16-20	1/4	£3.48
E5MJ-2N-45	1/2-20	1/8	£18.51
E5MJ-4N-45	1/2-20	1/4	£18.51
E6MJ-2N-45	9/16-18	1/8	£18.51
E6MJ-4N-45	9/16-18	1/4	£5.98
E6MJ-6N-45	9/16-18	3/8	£4.35
E6MJ-8N-45	9/16-18	1/2	£12.88
E8MJ-12N-45	3/4-16	3/4	£15.38
E8MJ-4N-45	3/4-16	1/4	£12.88
E8MJ-6N-45	3/4-16	3/8	£3.85
E8MJ-8N-45	3/4-16	1/2	£5.03
E10MJ-6N-45	7/8-14	3/8	£17.58
E10MJ-8N-45	7/8-14	1/2	£4.03
E10MJ-12N-45	7/8-4	3/4	£33.57
E12MJ-12N-45	1 1/16-12	3/4	£8.30
E12MJ-8N-45	1 1/16-12	1/2	£15.38
E16MJ-12N-45	1 5/16-12	3/4	£31.75
E16MJ-16N-45	1 5/16-12	1	£11.93
E20MJ-20N-45	1 5/8-12	1 1/4	£51.20
E24MJ-24N-45	1 7/8-12	1 1/2	£103.81
E32MJ-32N-45	2 1/2-12	2	£245.22

Male Elbow 90°

Male Thread JIC
Male Thread NPT



PGC: 283	JIC	NPT	Price
E4MJ-2N	7/16-20	1/8	£5.61
E4MJ-4N	7/16-20	1/4	£5.66
E4MJ-6N	7/16-20	3/8	£5.73
E4MJ-8N	7/16-20	1/2	£7.48
E5MJ-2N	1/2-20	1/8	£5.03
E5MJ-4N	1/2-20	1/4	£5.66
E6MJ-2N	9/16-18	1/8	£6.92
E6MJ-4N	9/16-18	1/4	£5.66
E6MJ-6N	9/16-18	3/8	£5.66
E6MJ-8N	9/16-18	1/2	£6.92
E8MJ-4N	3/4-20	1/4	£6.92
E8MJ-6N	3/4-20	3/8	£6.92
E8MJ-8N	3/4-20	1/2	£6.92
E8MJ-12N	3/4-20	3/4	£11.44
E10MJ-12N	7/8-14	3/4	£11.44
E10MJ-16N	7/8-14	1	£20.08
E10MJ-6N	7/8-14	3/8	£9.11
E10MJ-8N	7/8-14	1/2	£9.11
E12MJ-8N	1 1/16-12	1/2	£13.50
E12MJ-12N	1 1/16-12	3/4	£11.62
E12MJ-16N	1 1/16-12	1	£16.95
E16MJ-12N	1 5/16-12	3/4	£16.95
E16MJ-16N	1 5/16-12	1	£19.77
E16MJ-20N	1 5/16-12	1 1/4	£33.88
E20MJ-16N	1 5/8-12	1	£38.27
E20MJ-20N	1 5/8-12	1 1/4	£37.64
E24MJ-24N	1 7/8-12	1 1/2	£63.80
E32MJ-32N	2 1/2-12	2	£113.01

JIC to BSPP

Male Female Adaptors

Male Female Fixed Reducing Adaptor

Male Thread JIC
Female Thread BSPP



PGC: 283	JIC	BSPP	Price
MF4MJ-2PF	7/16-20	1/8	£8.74
MF4MJ-4PF	7/16-20	1/4	£8.74
MF4MJ-6PF	7/16-20	3/8	£10.30
MF4MJ-8PF	7/16-20	1/2	£21.84
MF6MJ-4PF	9/16-18	1/4	£7.98
MF6MJ-6PF	9/16-18	3/8	£10.75
MF6MJ-8PF	9/16-18	1/2	£13.25
MF8MJ-6PF	3/4-16	3/8	£11.24
MF8MJ-8PF	3/4-16	1/2	£11.24
MF10MJ-6PF	7/8-14	3/8	£13.31
MF10MJ-8PF	7/8-14	1/2	£12.00
MF12MJ-8PF	1 1/16-12	1/2	£32.32
MF12MJ-12PF	1 1/16-12	3/4	£23.91
MF16MJ-16PF	1 5/16-12	1	£32.00
MF20MJ-20PF	1 5/8-12	1 1/4	£51.13
MF24MJ-24PF	1 7/8-12	1 1/2	£63.61

Male Female Swivel Adaptor

Male Thread JIC
Female Thread BSPP



PGC: 283	JIC	BSPP	Price
MF4J-2P	7/16-20	1/8	£4.97
MF4J-4P	7/16-20	1/4	£4.97
MF4J-6P	7/16-20	3/8	£6.04
MF4J-8P	7/16-20	1/2	£6.04
MF5J-4P	1/2-20	1/4	£4.97
MF5J-6P	1/2-20	3/8	£6.04
MF5J-8P	1/2-20	1/2	£6.04
MF6J-4P	9/16-18	1/4	£4.97
MF6J-6P	9/16-18	3/8	£5.35
MF6J-8P	9/16-18	1/2	£5.35
MF8J-6P	3/4-16	3/8	£5.35
MF8J-8P	3/4-16	1/2	£5.66
MF8J-12P	3/4-16	3/4	£8.49
MF10J-6P	7/8-14	3/8	£5.98
MF10J-8P	7/8-14	1/2	£5.98
MF10J-10P	7/8-14	5/8	£9.11
MF10J-12P	7/8-14	3/4	£9.11
MF12J-12P	1 1/16-12	3/4	£9.11
MF12J-16P	1 1/16-12	1	£13.25
MF16J-12P	1 5/16-12	3/4	£13.50
MF16J-16P	1 5/16-12	1	£13.50
MF20J-20P	1 5/8-12	1 1/4	£30.18
MF24J-24P	1 7/8-12	1 1/2	£44.67

Male Adaptors

Male Adaptor

Male Thread JIC
Male Thread BSPP



• Supplied complete with O-ring and retaining ring

PGC: 283	JIC	BSPP	Price
MF2P-4J	7/16-20	1/8	£5.10
MF4P-4J	7/16-20	1/4	£5.10
MF6P-4J	7/16-20	3/8	£5.10
MF4P-5J	1/2-20	1/4	£5.10
MF6P-5J	1/2-20	3/8	£5.35
MF8P-4J	7/16-20	1/2	£5.35
MF4P-6J	9/16-18	1/4	£5.35
MF6P-6J	9/16-18	3/8	£5.35
MF8P-6J	9/16-18	1/2	£5.10
MF4P-8J	3/4-16	1/4	£6.10
MF6P-8J	3/4-16	3/8	£5.10
MF8P-8J	3/4-16	1/2	£5.35
MF8P-10J	7/8-14	1/2	£5.98
MF12P-10J	7/8-14	3/4	£9.49
MF6P-12J	1 1/16-12	3/8	£22.28
MF8P-12J	1 1/16-12	1/2	£10.75
MF12P-12J	1 1/16-12	3/4	£10.75
MF16P-12J	1 1/16-12	1	£19.15
MF12P-14J	1 3/16-12	3/4	£15.06
MF12P-16J	1 5/16-12	3/4	£14.94
MF16P-16J	1 5/16-12	1	£19.15
MF20P-16J	1 5/16-12	1 1/4	£30.81
MF20P-20J	1 5/8-12	1 1/4	£30.81
MF24P-24J	1 7/8-12	1 1/2	£45.49

Male Elbows

Adjustable Elbow 45°

Male Thread JIC
Male Thread BSPP



• Supplied complete with O-ring and retaining ring

PGC: 283	JIC	BSPP	Price
E4J-2P-ADJ-45	7/16-20	1/8	£17.27
E4J-4P-ADJ-45	7/16-20	1/4	£20.08
E6J-4P-ADJ-45	9/16-18	1/4	£19.15
E6J-6P-ADJ-45	9/16-18	3/8	£23.85
E8J-6P-ADJ-45	3/4-16	3/8	£27.93
E8J-8P-ADJ-45	3/4-16	1/2	£28.36
E12MJ-8P-ADJ-45	7/8-14	5/8	£29.31
E12J-12P-ADJ-45	1 1/16-12	3/4	£31.49
E16J-16P-ADJ-45	1 5/16-12	1	£37.76

Adjustable Elbow 90°

Male Thread JIC / BSPP



- Supplied complete with O-ring and retaining ring

PGC: 283	JIC	BSPP	Price
E4J-2P-ADJ	7/16-20	1/8	£12.50
E4J-4P-ADJ	7/16-20	1/4	£6.92
E5J-4P-ADJ	1/2-20	1/4	£17.58
E5J-6P-ADJ	1/2-20	3/8	£18.28
E6J-4P-ADJ	9/16-18	1/4	£7.36
E6J-6P-ADJ	9/16-18	3/8	£8.05
E6J-8P-ADJ	9/16-18	1/2	£16.01
E8J-4P-ADJ	3/4-16	1/4	£30.36
E8J-6P-ADJ	3/4-16	3/8	£8.05
E8J-8P-ADJ	3/4-16	1/2	£10.54
E8J-12P-ADJ	3/4-16	3/4	£24.60
E10J-6P-ADJ	7/8-14	3/8	£22.04
E10J-8P-ADJ	7/8-14	1/2	£10.75
E10J-12P-ADJ	7/8-14	3/4	£32.32
E12J-8P-ADJ	1 1/16-12	1/2	£25.29
E12J-12P-ADJ	1 1/16-12	3/4	£14.31
E12J-16P-ADJ	1 1/16-12	1	£56.34
E16J-12P-ADJ	1 5/16-12	3/4	£50.88
E16J-16P-ADJ	1 5/16-12	1	£22.72
E16J-20P-ADJ	1 5/16-12	1 1/4	£85.00
E20J-16P-ADJ	1 5/8-12	1	£84.24
E20J-20P-ADJ	1 5/8-12	1 1/4	£43.03
E24J-24P-ADJ	1 7/8-12	1 1/2	£70.82
E32J-24P-ADJ	2 1/2-12	1 1/2	£418.30
E32J-32P-ADJ	2 1/2-12	2	£427.15

Tees

Male Adjustable

Run Tee
Male Thread JIC / BSPP



- Supplied complete with O-ring and retaining ring

PGC: 283	JIC	BSPP	Price
T4MJ-2P-RT	7/16-20	1/8	£28.56
T5MJ-4P-RT	1/2-20	1/4	£31.70
T6MJ-4P-RT	9/16-18	1/4	£26.98
T6MJ-6P-RT	9/16-18	3/8	£32.13
T8MJ-6P-RT	3/4-16	3/8	£38.59
T8MJ-8P-RT	3/4-16	1/2	£38.84
T10MJ-6P-RT	7/8-14	3/8	£50.06
T10MJ-8P-RT	7/8-14	1/2	£47.99
T12MJ-12P-RT	1 1/16-12	3/4	£50.06
T14MJ-12P-RT	1 3/16-12	3/4	£76.15
T16MJ-16P-RT	1 5/16-12	1	£86.75
T20MJ-20P-RT	1 5/8-12	1 1/4	£120.74
T24MJ-24P-RT	1 7/8-12	1 1/2	£176.68

Male Adjustable

Branch Tee BSPP
Male Thread JIC / BSPP



- Supplied complete with O-ring and retaining ring

PGC: 283	JIC	BSPP	Price
T4MJ-2P-BT	7/16-20	1/8	£28.56
T4MJ-4P-BT	7/16-20	1/4	£31.49
T6MJ-4P-BT	9/16-18	1/4	£17.32
T8MJ-6P-BT	3/4-16	3/8	£38.59
T10MJ-8P-BT	7/8-14	1/2	£47.99
T12MJ-12P-BT	1 1/16-12	3/4	£50.06
T14MJ-12P-BT	1 3/16-12	3/4	£76.15
T16MJ-16P-BT	1 5/16-12	1	£86.75
T20MJ-20P-BT	1 5/8-12	1 1/4	£120.74
T24MJ-24P-BT	1 7/8-12	1 1/2	£176.68

JIC to Metric

Male Adaptors

Male Adaptor

Male Thread JIC
Male Thread Metric



PGC: 283	JIC	Thread	Price
MM4J-M10	7/16-20	M10 x 1	£8.74
MM4J-M12	7/16-20	M12 x 1.5	£5.98
MM5J-M14	1/2-20	M14 x 1.5	£5.98
MM6J-M14	9/16-18	M14 x 1.5	£5.98
MM6J-M16	9/16-18	M16 x 1.5	£6.61
MM6J-M18	9/16-18	M18 x 1.5	£6.61
MM8J-M16	3/4-16	M16 x 1.5	£6.61
MM8J-M18	3/4-16	M18 x 1.5	£6.61
MM8J-M22	3/4-16	M22 x 1.5	£7.24
MM10J-M18	7/8-14	M18 x 1.5	£7.24
MM10J-M22	7/8-14	M22 x 1.5	£7.24
MM12J-M22	1 1/16-12	M22 x 1.5	£7.24
MM12J-M27	1 1/16-12	M27 x 1.5	£29.18
MM16J-M33	1 5/16-12	M33 x 1.5	£15.14

JIC to BSPT

Male Adaptors

Male Adaptor

Male Thread JIC / BSPT



PGC: 283	JIC	BSPT	Price
MM4J-2T	7/16-20	1/8	£2.39
MM4J-4T	7/16-20	1/4	£2.02
MM4J-6T	7/16-20	3/8	£2.96
MM5J-2T	1/2-20	1/8	£2.65
MM5J-4T	1/2-20	1/4	£3.03
MM6J-4T	9/16-18	1/4	£2.71
MM6J-6T	9/16-18	3/8	£3.03
MM6J-8T	9/16-18	1/2	£3.91
MM8J-4T	3/4-16	1/4	£3.48
MM8J-6T	3/4-16	3/8	£3.15
MM8J-8T	3/4-16	1/2	£3.15
MM8J-12T	3/4-16	3/4	£5.54
MM10J-6T	7/8-14	3/8	£4.22
MM10J-8T	7/8-14	1/2	£2.05
MM10J-12T	7/8-14	3/4	£6.23
MM12J-8T	1 1/16-12	1/2	£5.73
MM12J-12T	1 1/16-12	3/4	£4.60
MM16J-12T	1 5/16-12	3/4	£7.24
MM16J-16T	1 5/16-12	1	£7.53
MM20J-20T	1 5/8-12	1 1/4	£24.60
MM24J-24T	1 7/8-12	1 1/2	£52.44
MM32J-32T	2 1/2-12	2	£87.18

Male Elbows

Male Elbow

Male Thread JIC / BSPT



PGC: 283	JIC	BSPT	Price
E4J-2MT	7/16-20	1/8	£5.98
E4J-4MT	7/16-20	1/4	£6.36
E5J-2MT	1/2-20	1/8	£10.37
E5J-4MT	1/2-20	1/4	£11.62
E6J-4MT	9/16-18	1/4	£6.61
E6J-6MT	9/16-18	3/8	£6.61
E6J-8MT	9/16-18	1/2	£15.38
E8J-4MT	3/4-16	1/4	£7.86
E8J-6MT	3/4-16	3/8	£7.86
E8J-8MT	3/4-16	1/2	£8.11
E10J-8MT	7/8-14	1/2	£14.45
E10J-12MT	7/8-14	3/4	£13.19
E12J-12MT	1 1/16-12	3/4	£11.93
E16J-16MT	1 5/16-12	1	£20.78
E20J-20MT	1 5/8-12	1 1/4	£46.74

JIC to UNF

02

Adaptors & Adjustable Elbows

Male Adaptor

Male Thread JIC / UNF



PGC: 283	JIC	UNF	Price
MM4J-4UNF	7/16-20	7/16-20	£1.90
MM4J-6UNF	7/16-20	9/16-18	£2.15
MM5J-5UNF	1/2-20	1/2-20	£2.15
MM6J-4UNF	9/16-18	7/16-20	£2.15
MM6J-6UNF	9/16-18	9/16-18	£2.15
MM6J-8UNF	9/16-18	3/4-16	£2.96
MM6J-10UNF	9/16-18	7/8-14	£3.15
MM8J-6UNF	3/4-16	9/16-18	£2.60
MM8J-8UNF	3/4-16	3/4-16	£2.39
MM8J-10UNF	3/4-16	7/8-14	£2.90
MM10J-8UNF	7/8-14	3/4-16	£2.78
MM10J-10UNF	7/8-14	7/8-14	£2.84
MM10J-12UNF	7/8-14	1 1/16-12	£5.03
MM12J-10UNF	1 1/16-12	7/8-14	£4.53
MM12J-12UNF	1 1/16-12	1 1/16-12	£4.03
MM12J-16UNF	1 1/16-12	1 5/16-12	£9.11
MM14J-14UNF	1 3/16-12	1 3/16-12	£8.11
MM16J-12UNF	1 5/16-12	1 1/16-12	£6.23
MM16J-16UNF	1 5/16-12	1 5/16-12	£6.36
MM20J-16UNF	1 5/8-12	1 5/8-12	£13.19
MM20J-20UNF	1 5/8-12	1 5/8-12	£11.55
MM20J-24UNF	1 7/8-12	1 7/8-12	£18.45
MM32J-32UNF	2 1/2-12	2 1/2-12	£39.97

Male Female Swivel Adaptor

Female Thread JIC
Male Thread UNF



PGC: 283	JIC	UNF	Price
MF4UNF-4J	7/16-20	7/16-20	£7.86
MF6UNF-6J	9/16-18	9/16-18	£8.86
MF8UNF-8J	3/4-16	3/4-16	£9.80
MF10UNF-10J	7/8-14	7/8-14	£13.19
MF12UNF-12J	1 1/16-12	1 1/16-12	£16.07
MF16UNF-16J	1 5/16-12	1 5/16-12	£24.85
MF20UNF-20J	1 5/8-12	1 5/8-12	£61.48
MF24UNF-24J	1 7/8-12	1 7/8-12	£166.01
MF32UNF-32J	2 1/2-12	2 1/2-12	£194.75

Adjustable Elbow 90°

Male Thread JIC / UNF



• Complete with O-ring

PGC: 283	JIC	UNF	Price
E4J-4UNF-ADJ	7/16-20	7/16-20	£5.98
E4J-6UNF-ADJ	7/16-20	9/16-18	£12.31
E4J-8UNF-ADJ	7/16-20	3/4-16	£15.38
E5J-4UNF-ADJ	1/2-20	7/16-20	£16.32
E5J-5UNF-ADJ	1/2-20	1/2-20	£12.44
E5J-6UNF-ADJ	1/2-20	9/16-18	£17.82
E6J-4UNF-ADJ	9/16-18	7/16-20	£9.49
E6J-5UNF-ADJ	9/16-18	1/2-20	£13.50
E6J-6UNF-ADJ	9/16-18	9/16-18	£5.66
E6J-8UNF-ADJ	9/16-18	3/4-16	£12.06
E6J-10UNF-ADJ	9/16-18	7/8-14	£15.38
E6J-12UNF-ADJ	9/16-18	1 1/16-12	£21.59
E8J-6UNF-ADJ	3/4-16	9/16-18	£12.44
E8J-8UNF-ADJ	3/4-16	3/4-16	£8.17
E8J-10UNF-ADJ	3/4-16	7/8-14	£14.75
E8J-12UNF-ADJ	3/4-16	1 1/16-12	£21.03
E8J-16UNF-ADJ	3/4-16	1 5/16-12	£60.54
E10J-6UNF-ADJ	7/8-14	9/16-18	£16.01
E10J-8UNF-ADJ	7/8-14	3/4-16	£14.75
E10J-10UNF-ADJ	7/8-14	7/8-14	£11.88
E10J-12UNF-ADJ	7/8-14	1 1/16-12	£17.64
E12J-8UNF-ADJ	1 1/16-12	3/4-16	£23.47
E12J-10UNF-ADJ	1 1/16-12	7/8-14	£24.55
E12J-12UNF-ADJ	1 1/16-12	1 1/16-12	£15.38
E12J-16UNF-ADJ	1 1/16-12	1 5/16-12	£27.30
E14J-12UNF-ADJ	1 3/16-12	1 1/16-12	£37.52
E14J-14UNF-ADJ	1 3/16-12	1 3/16-12	£36.77
E16J-12UNF-ADJ	1 5/16-12	1 1/16-12	£30.25
E16J-16UNF-ADJ	1 5/16-12	1 5/16-12	£21.90
E16J-20UNF-ADJ	1 5/8-12	1 5/8-12	£73.71
E20J-16UNF-ADJ	1 5/8-12	1 5/16-12	£69.68
E20J-20UNF-ADJ	1 5/8-12	1 5/8-12	£56.83
E24J-20UNF-ADJ	1 7/8-12	1 5/8-12	£75.59
E24J-24UNF-ADJ	1 7/8-12	1 7/8-12	£76.60
E24J-24UNF-ADJ	1 7/8-12	1 7/8-12	£75.96
E32J-24UNF-ADJ	2 1/2-12	1 7/8-12	£213.48
E32J-32UNF-ADJ	2 1/2-12	2 1/2-12	£205.78

Adjustable Elbow 45°

Male Thread JIC / UNF



• Complete with O-ring

PGC: 283	JIC	UNF	Price
E4J-4UNF-ADJ-45	7/16-20	7/16-20	£6.41
E4J-6UNF-ADJ-45	7/16-20	9/16-18	£22.91
E5J-5UNF-ADJ-45	1/2-20	1/2-20	£18.71
E6J-4UNF-ADJ-45	9/16-18	7/16-20	£22.91
E6J-6UNF-ADJ-45	9/16-18	9/16-18	£6.61
E6J-8UNF-ADJ-45	9/16-18	3/4-16	£30.57
E6J-10UNF-ADJ-45	9/16-18	7/8-14	£37.52
E8J-6UNF-ADJ-45	3/4-16	9/16-18	£30.57
E8J-8UNF-ADJ-45	3/4-16	3/4-16	£8.62
E8J-10UNF-ADJ-45	3/4-16	7/8-14	£37.96
E10J-8UNF-ADJ-45	7/8-14	3/4-16	£37.96
E10J-10UNF-ADJ-45	7/8-14	7/8-14	£10.37
E10J-12UNF-ADJ-45	7/8-14	1 1/16-12	£44.23
E12J-10UNF-ADJ-45	1 1/16-12	7/8-14	£44.23
E12J-12UNF-ADJ-45	1 1/16-12	1 1/16-12	£14.31
E12J-16UNF-ADJ-45	1 1/16-12	1 5/16-12	£43.79
E14J-14UNF-ADJ-45	1 3/16-12	1 3/16-12	£94.71
E16J-12UNF-ADJ-45	1 5/16-12	1 1/16-12	£57.40
E16J-16UNF-ADJ-45	1 5/16-12	1 5/16-12	£22.85
E20J-16UNF-ADJ-45	1 5/8-12	1 5/16-12	£90.63
E20J-20UNF-ADJ-45	1 5/8-12	1 5/8-12	£65.55
E24J-24UNF-ADJ-45	1 7/8-12	1 7/8-12	£90.02
E32J-32UNF-ADJ-45	2 1/2-12	2 1/2-12	£265.66

Tees

Ancillary Components

Male Adjustable Run Tee

Male Thread JIC / UNF



PGC: 283	JIC	UNF	Price
T4MJ-4UNF-RT	7/16-20	7/16-20	£14.14
T5MJ-5UNF-RT	1/2-20	1/2-20	£21.03
T6MJ-6UNF-RT	9/16-18	9/16-18	£18.45
T8MJ-8UNF-RT	3/4-16	3/4-16	£24.22
T10MJ-10UNF-RT	7/8-14	7/8-14	£28.61
T12MJ-12UNF-RT	1 1/16-12	1 1/16-12	£37.52
T14MJ-14UNF-RT	1 3/16-12	1 3/16-12	£119.04
T16MJ-16UNF-RT	1 5/16-12	1 5/16-12	£60.22
T20MJ-20UNF-RT	1 5/8-12	1 5/8-12	£138.30

Male Adjustable Branch Tee

Male Thread JIC / UNF



PGC: 283	JIC	UNF	Price
T4MJ-4UNF-BT	7/16-20	7/16-20	£14.14
T5MJ-5UNF-BT	1/2-20	1/2-20	£21.03
T6MJ-6UNF-BT	9/16-18	9/16-18	£18.45
T8MJ-8UNF-BT	3/4-16	3/4-16	£36.14
T8MJ-8UNF-BT	3/4-16	3/4-16	£24.22
T10MJ-10UNF-BT	7/8-14	7/8-14	£28.61
T12MJ-12UNF-BT	1 1/16-12	1 1/16-12	£37.52
T14MJ-14UNF-BT	1 3/16-12	1 3/16-12	£119.04
T16MJ-16UNF-BT	1 5/16-12	1 5/16-12	£60.22
T20MJ-20UNF-BT	1 5/8-12	1 5/8-12	£138.30

Gauge Adaptor BSPP

 Male Thread JIC
 Female Thread BSPP

PGC: 283	JIC	BSPP	Price
GC4J-4P	7/16-20	1/4	£23.85
GC5J-4P	1/2-20	1/4	£23.85
GC6J-4P	9/16-18	1/4	£23.85
GC8J-4P	3/4-16	1/4	£23.85

Tube End Reducer

 Male Thread JIC
 Female Thread JIC

PGC: 283.	JIC 1	JIC 2	Price
R4-5J	7/16-20	1/2-20	£15.51
R4-6J	7/16-20	9/16-18	£7.30
R4-8J	7/16-20	3/4-6	£6.98
R4-10J	7/16-20	7/8-14	£11.80
R4-12J	7/16-20	1 1/16-12	£17.32
R4-16J	7/16-20	1 5/16-12	£23.21
R5-6J	1/2-20	9/16-18	£10.11
R5-8J	1/2-20	3/4-16	£29.86
R6-8J	9/16-18	3/4-16	£6.41
R6-10J	9/16-18	7/8-14	£10.11
R6-12J	9/16-18	1 1/16-12	£17.32
R6-16J	9/16-18	1 5/16-12	£29.99
R8-10J	3/4-16	7/8-14	£10.43
R8-12J	3/4-16	1 1/16-12	£8.41
R8-16J	3/4-16	1 5/16-12	£18.45
R8-20J	3/4-16	1 5/8-12	£32.75
R10-12J	7/8-14	1 1/16-12	£16.20
R10-16J	7/8-14	1 5/16-12	£20.41
R10-20J	7/8-14	1 5/8-12	£34.13
R10-24J	7/8-14	1 7/8-12	£74.26
R12-14J	1 1/16-12	1 3/16-12	£28.48
R12-16J	1 1/16-12	1 5/16-12	£15.14
R12-20J	1 1/16-12	1 5/8-12	£30.81
R12-24J	1 1/16-12	1 7/8-12	£48.43
R16-20J	1 5/16-12	1 5/8-12	£19.71
R16-24J	1 5/16-12	1 7/8-12	£36.39
R20-24J	1 5/8-12	1 7/8-12	£51.57
R24-32J	1 7/8-12	2 1/2-12	£100.91

Bulkhead Locknut

Female Thread JIC



PGC: 283	JIC	Price
LN4J	7/16-20	£1.02
LN5J	1/2-20	£1.21
LN6J	9/16-18	£1.34
LN8J	3/4-16	£0.37
LN10J	7/8-14	£1.90
LN12J	1 1/16-12	£4.16
LN14J	1 3/16-12	£5.66
LN16J	1 5/16-12	£5.61
LN20J	1 5/8-12	£7.36
LN24J	1 7/8-12	£8.49

Male Plug

Male Thread JIC



PGC: 283	JIC	Price
HP4MJ	7/16-20	£1.26
HP5MJ	1/2-20	£1.47
HP6MJ	9/16-18	£1.26
HP8MJ	3/4-16	£1.69
HP10MJ	7/8-14	£1.96
HP12MJ	1 1/16-12	£2.52
HP14MJ	1 3/16-12	£6.16
HP16MJ	1 5/16-12	£6.61
HP20MJ	1 5/8-12	£10.80
HP24MJ	1 7/8-12	£13.93
HP32MJ	2 1/2-12	£31.06

Female Cap

Female Thread JIC



PGC: 283	JIC	Price
C4FJ	7/16-20	£1.84
C5FJ	1/2-20	£2.22
C6FJ	9/16-18	£1.90
C8FJ	3/4-16	£2.15
C10FJ	7/8-14	£2.47
C12FJ	1 1/16-12	£4.22
C14FJ	1 3/16-12	£4.22
C16FJ	1 5/16-12	£6.16
C20FJ	1 5/8-12	£10.05
C24FJ	1 7/8-12	£15.82
C32FJ	2 1/2-12	£44.04



X65 Series 165 Couplings

- Flat-Face design
- One hand operated
- Extra security locking

CEJN® Series 165 is a Flat-Face quick-connect coupling for low- and medium-pressure hydraulic applications.

The Flat-Face design minimises spillage during connection and disconnection.

Series 165 couplings require only one hand for operation, making connection and disconnection fast and easy. Series 165 couplings feature manual security locking as added protection against involuntary disconnection.



Temperature Range:
-30°C to +100°C



Maximum Working Pressure:
400 bar
(5800 psi)

Technical Data Summary

Specification Details	
Nominal Flow Diameter	5.0 mm
Coupling Material	Steel
Nipple Material	Hardened steel
Environmental	
Temperature Range	-30°C to +100°C
Flow Rate	
Maximum Flow Rate @ 1 bar (0.1 p.d.)	3.6 l/min (0.8 gpm uk)
Pressure Rating	
Minimum Burst Pressure	26105 psi (1800 bar)

CEJN® Series 165 Female Coupling

Female Thread BSPP



PGC: 546	BSPP	Price
101651201	1/8	£38.02

CEJN® Series 165 Female Adaptor

Female Thread BSPP



PGC: 546	BSPP	Price
101656201	1/8	£17.39



X65 Series 265 Couplings

- Flat-Face design
- One hand operated
- Extra security locking

CEJN® Series 265 is a Flat-Face quick-connect coupling according to and exceeding the ISO 16028 Standard for low- and medium-pressure hydraulic applications.

The Flat-Face design minimises spillage during connection and disconnection. Series 265 couplings require only one hand for operation, making connection and disconnection fast and easy. Dust caps are available as accessories for both the coupling and nipple when disconnected to prevent dust and debris from entering the system. Series 265 couplings feature manual security locking as added protection against involuntary disconnection.



Technical Data Summary

Specification Details	
Nominal Flow Diameter	6.3 mm
Coupling Material	Steel
Nipple Material	Hardened steel
Environmental	
Temperature Range	-30°C to +100°C
Flow Rate	
Maximum Flow Rate @ 1 bar (0.1 p.d.)	12 l/min (6.6 cfm)
Pressure Rating	
Minimum Burst Pressure	2170 psi (1500 bar)

 **Temperature Range:**
-30°C to +100°C

 **Maximum Working Pressure:**
500 bar; (720 psi)

**CEJN® Series 265
Female Coupling**
Female Thread BSPT



PGC: 546	BSPT	Price
102651102	1/4	£23.34

**CEJN® Series 265
Female Coupling**
Female Thread BSPP



PGC: 546	BSPP	Price
102651202	1/4	£22.44

**CEJN® Series 265
Female Coupling
(FPM Seal)**
Female Thread BSPP



PGC: 546	BSPP	Price
102651212	1/4	£23.58

**CEJN® Series 265
Female Nipple**
Female Thread BSPT



PGC: 546	BSPT	Price
102656102	1/4	£11.97

**CEJN® Series 265
Female Nipple**
Female Thread BSPP



PGC: 546	BSPP	Price
102656202	1/4	£11.64

**CEJN® Series 265
Female Nipple
(FPM Seal)**
Female Thread BSPP



PGC: 546	BSPP	Price
102656212	1/4	£12.21



X65 Series 365 Couplings

- Flat-Face design
- One hand operated
- Extra security locking

CEJN® Series 365 is a Flat-Face quick-connect coupling according to and exceeding the ISO 16028 Standard for low- and medium-pressure hydraulic applications.

The Flat-Face design minimises spillage during connection and disconnection. Series 365 couplings require only one hand for operation, making connection and disconnection fast and easy. Dust caps are available as accessories for both the coupling and nipple when disconnected to prevent dust and debris from entering the system. Series 365 couplings feature manual security locking as added protection against involuntary disconnection.



Temperature Range:
-30°C to +100°C



Maximum Working Pressure:
400 bar; (5800 psi)



Technical Data Summary

Specification Details	
Nominal Flow Diameter	10.0 mm
Coupling Material	Steel
Nipple Material	Hardened steel
Environmental	
Temperature Range	-30°C to +100°C
Flow Rate	
Maximum Flow Rate @ 1 bar (0.1 p.d.)	74 l/min (16 gpm uk)
Pressure Rating	
Minimum Burst Pressure	17000 psi (1200 bar)

CEJN® Series 365 Female Coupling

Female Thread BSPT



PGC: 546	BSPT	Price
103651104	3/8	£27.06

CEJN® Series 365 Female Coupling (FPM Seal)

Female Thread BSPP



PGC: 546	BSPP	Price
103651214	3/8	£27.19
103651215	1/2	£27.19

CEJN® Series 365 Female Coupling (FPM Seal)

Female Thread BSPP



PGC: 546	BSPP	Price
103651204	3/8	£25.92
103651205	1/2	£25.92

CEJN® Series 365 Female Adaptor

Female Thread BSPP



PGC: 546	BSPP	Price
103656204	3/8	£13.51
103656205	1/2	£25.92

CEJN® Series 365 Female Adaptor

Female Thread BSPT



PGC: 546	BSPT	Price
103656104	3/8	£14.25

CEJN® Series 365 Female Adaptor (FPM Seal)

Female Thread BSPP



PGC: 546	BSPP	Price
103656214	3/8	£14.18
103656215	1/2	£15.15



X65 Series 565 Couplings

- Flat-Face design
- One hand operated
- Extra security locking

CEJN® Series 565 is a Flat-Face quick-connect coupling according to and exceeding the ISO 16028 Standard for low- and medium-pressure hydraulic applications. The Flat-Face design minimises spillage during connection and disconnection.

Series 565 couplings require only one hand for operation, making connection and disconnection fast and easy. Dust caps are available as accessories for both the coupling and nipple when disconnected to prevent dust and debris from entering the system. Series 565 couplings feature manual security locking as added protection against involuntary disconnection.



Technical Data Summary

 **Temperature Range:**
-30°C to +100°C

 **Maximum Working Pressure:**
400 bar; (5800 psi)

Specification Details	
Nominal Flow Diameter	6.3 mm
Coupling Material	Steel
Nipple Material	Hardened steel
Environmental	
Temperature Range	-30°C to +100°C
Flow Rate	
Maximum Flow Rate @ 1 bar (0.1 p.d.)	100 l/min (22 cfm)
Pressure Rating	
Minimum Burst Pressure	2170 psi (1500 bar)

**CEJN® Series 565
Female Coupling**
Female Thread BSPT



PGC: 546	BSPT	Price
105651105	1/2	£37.92

**CEJN® Series 565
Female Coupling (FPM Seal)**
Female Thread BSPP



PGC: 546	BSPP	Price
105651215	1/2	£38.36
105651217	3/4	£39.73

**CEJN® Series 565
Female Coupling**
Female Thread BSPP



PGC: 546	BSPP	Price
105651205	1/2	£36.52
105651207	3/4	£37.82

**CEJN® Series 565
Female Adaptor**
Female Thread BSPP



PGC: 546	BSPP	Price
105656205	1/2	£20.94
105656207	3/4	£22.74

**CEJN® Series 565
Female Adaptor**
Female Thread BSPT



PGC: 546	BSPT	Price
105656105	1/2	£21.54

**CEJN® Series 565
Female Adaptor (FPM Seal)**
Female Thread BSPP



PGC: 546	BSPP	Price
105656215	1/2	£21.94
105656217	3/4	£23.88



X65 Series 665 Couplings

- Flat-Face design
- One hand operated
- Extra security locking

CEJN® Series 665 is a Flat-Face quick-connect coupling according to and exceeding the ISO 16028 Standard for low- and medium-pressure hydraulic applications. The Flat-Face design minimises spillage during connection and disconnection.

Series 665 couplings require only one hand for operation, making connection and disconnection fast and easy. Dust caps are available as accessories for both the coupling and nipple when disconnected to prevent dust and debris from entering the system. Series 665 couplings feature manual security locking as added protection against involuntary disconnection.



Temperature Range:
-30°C to +100°C



Maximum Working Pressure:
720 bar; (10440 psi)



Technical Data Summary

Specification Details	
Nominal Flow Diameter	5.0 mm
Coupling Material	Steel
Nipple Material	Hardened steel
Environmental	
Temperature Range	-30°C to +100°C
Flow Rate	
Maximum Flow Rate @ 1 bar (0.1 p.d.)	3.6 l/min (0.8 gpm uk)
Pressure Rating	
Minimum Burst Pressure	26105 psi (1800 bar)

CEJN® Series 665 Female Coupling

Female Thread BSPP



PGC: 546	BSPP	Price
106651201	3/4	£52.84

CEJN® Series 665 Female Coupling (FPM Seal)

Female Thread BSPT



PGC: 546	BSPP	Price
106651211	3/4	£55.51

CEJN® Series 665 Female Adaptor

Female Thread BSPP



PGC: 546	BSPP	Price
106656201	3/4	£28.73

CEJN® Series 665 Female Adaptor (FPM Seal)

Female Thread BSPP



PGC: 546	BSPP	Price
106656211	3/4	£30.13



X65 Series 765 Couplings

- Flat-Face design
- One hand operated
- Extra security locking

CEJN® Series 765 is a Flat-Face quick-connect coupling according to and exceeding the ISO 16028 Standard for low- and medium-pressure hydraulic applications. The Flat-Face design minimises spillage during connection and disconnection.

Series 765 couplings require only one hand for operation, making connection and disconnection fast and easy. Dust caps are available as accessories for both the coupling and nipple when disconnected to prevent dust and debris from entering the system. Series 765 couplings feature manual security locking as added protection against involuntary disconnection.



Technical Data Summary

Specification Details	
Nominal Flow Diameter	6.3 mm
Coupling Material	Steel
Nipple Material	Hardened steel
Environmental	
Temperature Range	-30°C to +100°C
Flow Rate	
Maximum Flow Rate @ 1 bar (0.1 p.d.)	12 l/min (6.6 cfm)
Pressure Rating	
Minimum Burst Pressure	2170 psi (1500 bar)

 **Temperature Range:**
-30°C to +100°C

 **Maximum Working Pressure:**
500 bar; (720 psi)

CEJN® Series 765 Female Coupling

Female Thread BSPT



PGC: 546	BSPT	Price
107651103	1	£91.26

CEJN® Series 765 Female Coupling (FPM Seal)

Female Thread BSPP



PGC: 546	BSPP	Price
107651211	3/4	£95.41
107651213	1	£95.41

CEJN® Series 765 Female Coupling

Female Thread BSPP



PGC: 546	BSPP	Price
107651201	3/4	£90.90
107651203	1	£90.90

CEJN® Series 765 Female Adaptor

Female Thread BSPP



PGC: 546	ID (")	Price
107656201	3/4	£44.55
107656203	1	£90.90

CEJN® Series 765 Female Adaptor

Female Thread BSPT



PGC: 546	BSPP	Price
107656103	1	£45.28

CEJN® Series 765 Female Adaptor(FPM Seal)

Female Thread BSPP



PGC: 546	ID (")	Price
107656211	3/4	£46.79
107656213	1	£47.15



X66 Series 266, 366, 566, 766 Couplings

- All metal components made of AISI 316 stainless steel
- Minimize contamination of your hydraulic system
- Spill free connection
- High performance

CEJN® X66 Series 266, 366, 566 and 766 are Flat-Faced quick-connect couplings dimensionally in accordance to ISO 16028 Standard for low- and medium-pressure hydraulic applications. The Flat-Face design minimizes spillage during connection and disconnection. The stainless steel design makes it extra sturdy to fit applications in extreme environments.

Series X66 couplings require only one hand for operation, making connection and disconnection fast and easy. Dust caps are available as accessories for both the coupling and nipple to prevent dust and debris from entering the system. Series X66 couplings also feature manual security locking as added protection against involuntary disconnection.



Technical Data Summary

Specification Details	Series 266	Series 366	Series 566	Series 766
Maximum Flow Rate @ 1 bar (0.1 p.d.)	24 l/min (5.3 GPM)	44 l/min (9.7 GMP)	93 l/min (20.5 GMP)	188 l/min (41.4 GMP)
Body Size	1/4	3/8	1/2	3/4
Dia (mm)	16.1	18.7	24.5	30.0
Material	Stainless Steel	Stainless Steel	Stainless Steel	Stainless Steel
Material seal	Viton (FPM)	Viton (FPM)	Viton (FPM)	Viton (FPM)
Environmental				
Temperature Range	-20°C to +205°C	-20°C to +205°C	-20°C to +205°C	-20°C to +205°C
Pressure Rating				
Minimum Burst Pressure	14500 psi (1000 bar)	14500 psi (1000 bar)	14500 psi (1000 bar)	14500 psi (1000 bar)
Maximum Working Pressure	3630 psi (250 bar)	3630 psi (250 bar)	3630 psi (250 bar)	3630 psi (250 bar)



Temperature Range:
-20°C to +205°C



Maximum Working Pressure:
250 bar, (3630 psi)

CEJN® X Series 266, 366, 566 and 766 Female Coupling

Female Thread BSP



PGC: 546	BSP	Price
102661212	1/4	£200.66
103661214	3/8	£229.15
103661215	1/2	£231.92
105661215	1/2	£285.33
105661217	3/4	£288.81
107661211	3/4	£419.20

CEJN® X Series 266, 366, 566 and 766 Female Adaptor

Female Thread BSP



PGC: 546	BSP	Price
102666212	1/4	£116.41
103666214	3/8	£125.54
103666215	1/2	£156.78
105666217	1/2	£159.59
105666215	3/4	£156.78
107666211	3/4	£231.02



TLX Series 607, 707, 807 Couplings

- Extremely high resilience to surge flows.
- Handles the pressure impulses.
- Designated for the toughest construction and demolition applications.

New



CEJN® TLX Series 607, 707, 807 are a flat-face Twist Lock Coupling made of high alloy steel and critical components are hardened for maximum performance.

The surface treatment is Zinc-Nickel which is by far the best surface treatment of steel available. The TLX is a spill free coupling and fully in line with CEJN's ambition to supply products for clean and leak-free hydraulic systems.

The flow rate of the TLX is not limited to a certain level as it can handle really high flow without failures. The limitation is on the part of the machine as you don't want to get too high a pressure drop as this will lead to heat build-up in the hydraulic system. If you choose the appropriate size TLX for the flow rate the pump generates, the TLX will also handle the surge flow that can occur in certain applications.



Temperature Range:
-30°C to +100°C



Maximum Working Pressure:
5800 psi (400 bar)

Technical Data Summary

Specification Details	Series 607	Series 707	Series 807
Maximum Flow Rate @ 1 bar (0.1 p.d.)	169 l/min (6.6 cfm)	291 l/min (6.6 cfm)	400 l/min (6.6 cfm)
Material	High alloy steels with Zinc-Nickel surface	High alloy steels with Zinc-Nickel surface	High alloy steels with Zinc-Nickel surface
Media	Compressed air, neutral gas	Compressed air, neutral gas	Compressed air, neutral gas
Environmental			
Temperature Range	-30°C to +100°C	-30°C to +100°C	-30°C to +100°C
Pressure Rating			
Minimum Burst Pressure	2300 psi (1600 bar)	2300 psi (1600 bar)	2300 psi (1600 bar)
Maximum Working Pressure	5800 psi (400 bar)	5800 psi (400 bar)	5800 psi (400 bar)

CEJN® TLX Series 607 Female Coupling
Female Thread



PGC: 546	Thread	Price
106071101	Rc 3/4	£124.83
106071301	G 3/4	£121.20
106071203	G1	£123.02
106071231	G 3/4	£124.83
106071601	SAE 1 1/16-12	£124.83

CEJN® TLX Series 707 Female Coupling
Female Thread



PGC: 546	Thread	Price
107071103	Rc 1	£157.21
107071203	G 1	£150.44
107071204	G 1	£160.97
107071233	G 1	£157.21
107071403	NPT 1	£157.21
107071603	SAE 1 5/16-12	£157.21

CEJN® TLX Series 807 Female Coupling
Female Thread



PGC: 546	Thread	Price
108071104	Rc 1/4	£254.19
108071204	G 1 1/4	£239.80
108071205	G 1 1/2	£256.59
108071234	G 1 1/4	£254.19
108071404	NPT 1 1/4	£254.19
108071604	SAE 1 5/8-12	£254.19

CEJN® TLX Series 607 Female Adaptor
Female Thread



PGC: 546	Thread	Price
106076101	Rc 3/4	£142.08
106076301	G 3/4	£137.94
106076203	G 1	£140.01
106076231	G 3/4	£142.08
106076401	NPT 3/4	£142.08
106076601	SAE 1 1/16-12	£142.08

CEJN® TLX Series 707 Female Adaptor
Female Thread



PGC: 546	Thread	Price
107076203	Rc 1	£202.78
107076204	G 1 1/4	£210.89
107076233	G 1	£209.88
107076403	NPT 1	£209.88
107076603	SAE 1 5/16-12	£209.88

CEJN® TLX Series 807 Female Adaptor
Female Thread



PGC: 546	Thread	Price
108076204	G 1 1/4	£260.55
108076205	G 1 1/2	£278.79
108076234	G 1 1/4	£274.88
108076404	NPT 1 1/4	£274.88
108076604	SAE 1 5/8-12	£274.88



X64 Series Pressure Eliminator Adaptors

- Flat-Face design
- One hand operated
- Connection under pressure
- Meets and exceeds ISO 16028 Standard



Temperature Range:
-30°C to +100°C



Technical Data Summary

The pressure eliminator nipples are available in five sizes; DN 6.3 (Series 264), DN 10.0 (Series 364), DN 12.5 (Series 564), DN 16 (Series 664), DN 19 (Series 764).

CEJN Series X64 is a Flat-Face quick-connect nipple with a built-in pressure eliminator. The nipple is according to and exceeds the demands in the ISO 16028 Standard for low- and medium-pressure hydraulic applications. The Flat-Face design minimizes spillage during connection and disconnection. The pressure eliminator allows for connection with residual/trapped pressure on the nipple side.

For steel couplings in accordance with ISO 16028 see Series 365. Stainless steel versions of the standard are available in Series 366.

Specification Details	Series 264	Series 364
Nominal Flow Diameter	6.3 mm	6.0 mm
Material	Nitrile (NBR)	Nitrile (NBR)
Media	Hardened steel	Hardened steel
Environmental		
Temperature Range	-30°C to +100°C	-30°C to +100°C
Pressure Rating		
Maximum Working Pressure	7252 psi (500 bar)	5802 psi (400 bar)
Minimum Burst Pressure	21766 psi (1500 bar)	17405 psi (1200 bar)
Flow Rate		
Maximum Flow Rate @ 1 bar (0.1 p.d.)	9 l/min (2.0 gpm uk)	19 l/min (4.2 gpm uk)

Series X64 Adaptors



Series 264 connects with couplings in Series 265, Series 266 and Series 262. For steel couplings in accordance with ISO 16028 see Series 265. Stainless steel versions of the standard are available in Series 266. Series 262 feature an interchangeable steel coupling designed for lower pressures.

Series 364 connects with couplings in Series 365, Series 366 and Series 362. For steel couplings in accordance with ISO 16028 see Series 365. Stainless steel versions of the standard are available in Series 366. Series 362 feature an interchangeable steel coupling designed for lower pressures.

CEJN® Series 264 Female Adaptor Female Thread BSPP

PGC: 545	BSPP	Price
102646202	1/4	£36.62

CEJN® Series 264 Female Adaptor Female Thread NPT

PGC: 545	NPT	Price
102646402	1/4	£37.39

CEJN® Series 364 Female Adaptor Female Thread BSPP

PGC: 545	BSPP	Price
103646204	3/8	£37.32
103646205	1/2	£46.49

CEJN® Series 364 Female Adaptor Female Thread NPT

PGC: 545	NPT	Price
103646404	3/8	£37.19

Specification Details		
Series 564	Series 664	Series 764
12.5 mm	16 mm	19 mm
Nitrile (NBR)	Nitrile (NBR)	Nitrile (NBR)
Hardened steel	Hardened steel	Hardened steel
-30°C to +100°C	-30°C to +100°C	-30°C to +100°C
5802 psi (400 bar)	5802 psi (400 bar)	5802 psi (400 bar)
17405 psi (1200 bar)	17405 psi (1200 bar)	17405 psi (1200 bar)
43 l/min (9.5 gpm uk)	70 l/min (4.2 gpm uk)	105 l/min (9.5 gpm uk)

Series 564 connects with couplings in Series 565, Series 566 and Series 562. For steel couplings in accordance with ISO 16028 see Series 565. Stainless steel versions of the standard are available in Series 566. Series 562 feature an interchangeable steel coupling designed for lower pressures.

Series 664 The nipple Series 664 connects with couplings in Series 665. For steel couplings in accordance with ISO 16028 see Series 665.

Series 764 connects with couplings in Series 765 and Series 766. For steel couplings in accordance with ISO 16028 see Series 765. Stainless steel versions of the standard are available in Series 766.

CEJN® Series 564 Female Adaptor		
Female Thread BSPP		
PGC: 545	BSPP	Price
105646205	1/3	£46.49
105646207	3/4	£47.19

CEJN® Series 664 Female Adaptor		
Female Thread BSPP		
PGC: 545	BSPP	Price
106646201	3/4	£59.73

CEJN® Series 764 Female Adaptor		
Female Thread BSPP		
PGC: 545	BSPP	Price
107646201	3/4	£66.48

CEJN® Series 564 Female Adaptor		
Female Thread NPT		
PGC: 545	NPT	Price
105646405	1/2	£47.02

CEJN® Series 664 Female Adaptor		
Female Thread NPT		
PGC: 545	NPT	Price
106646401	3/4	£59.21

CEJN® Series 764 Female Adaptor		
Female Thread NPT		
PGC: 545	NPT	Price
107646203	1	£66.48



ISO Couplings

- Positive quick connection ensured by the snap together locking ball system
- When connected the male and female halves can rotate, even under pressure, avoiding any torsional stress in the flexible hose
- Designed to withstand high pressure peaks and pulses
- Poppet valves have balanced springs and calibrated oil flow passages to minimise the pressure drop
- Poppet valve seals have shockproof protective edges

ISO A Couplings

PULL BREAK hydraulic couplings - 1/4" - 2" poppet valve types to ISO 7241 SERIES A

Holbury ISO A Series couplings are the ideal choice where a tough, durable product of superior quality is required. They are perfectly suited to industrial and agricultural applications. A poppet valve is used to minimise the pressure drop characteristics and provide a positive sealing arrangement.

Construction

- Zinc-plated, heat treated carbon steel
- Nitrile O-ring seals are fitted as standard
- Viton® seals are available on request

ISO A Coupling

Female Thread BSPP

 **Working Pressure:**
130 bar to 350 bar
(1885 psi to 5076 psi)



PGC: 285	BSPP	Working Pressure (bar)	Price
HQR1/4F-ISO-A	1/4	350	£9.91
HQR3/8F-ISO-A	3/8	300	£11.92
HQR1/2F-ISO-A	1/2	250	£14.45
HQR3/4F-ISO-A	3/4	250	£27.82
HQR1F-ISO-A	1	230	£42.25
HQR11/4F-ISO-A	1 1/4	230	£89.14
HQR11/2F-ISO-A	1 1/2	190	£126.76
HQR2F-ISO-A	2	130	£94.52

ISO A Plug

Female Thread BSPP



Working Pressure:
130 bar to 350 bar
(1885 psi to 5076 psi)



PGC: 285	BSPP	Working Pressure (bar)	Price
HQR1/4M-ISO-A	1/4	350	£4.20
HQR3/8M-ISO-A	3/8	300	£5.24
HQR1/2M-ISO-A	1/2	250	£5.66
HQR3/4M-ISO-A	3/4	250	£11.56
HQR1M-ISO-A	1	230	£17.08
HQR11/4M-ISO-A	1 1/4	230	£36.22
HQR11/2M-ISO-A	1 1/2	190	£52.11
HQR2M-ISO-A	2	130	£248.98

ISO B Couplings

PULL BREAK hydraulic couplings - 1/8" - 1" poppet valve types to ISO 7241 SERIES B

Holbury ISO B Series couplings are designed to be tough, durable and of superior quality to competing ISO 7241 products. They are ideally suited to heavy industrial applications which would typically include:

- Food processing and manufacture
- Shipbuilding
- Offshore
- Machine tool/automation
- Oil refineries
- Steel mills
- Chemicals and pharmaceuticals

Construction

- Heat-treated, carbon steel, zinc-plated
- Nitrile O-ring seals with Teflon® backing rings

ISO B Coupling

Female Thread BSPP



Working Pressure:
230 bar to 350 bar
(3335 psi to 5076 psi)



PGC: 285	BSPP	Working Pressure (bar)	Price
HQR1/8F-ISO-B	1/8	350	£22.13
HQR1/4F-ISO-B	1/4	300	£22.13
HQR3/8F-ISO-B	3/8	250	£24.58
HQR1/2F-ISO-B	1/2	250	£31.18
HQR3/4F-ISO-B	3/4	230	£55.24
HQR1F-ISO-B	1	230	£84.95

ISO B Plug

Female Thread BSPP



Working Pressure:
230 bar to 350 bar
(3335 psi to 5076 psi)



PGC: 285	BSPP	Working Pressure (bar)	Price
HQR1/8M-ISO-B	1/8	350	£9.91
HQR1/4M-ISO-B	1/4	300	£9.91
HQR3/8M-ISO-B	3/8	250	£10.76
HQR1/2M-ISO-B	1/2	250	£11.27
HQR3/4M-ISO-B	3/4	230	£25.72
HQR1M-ISO-B	1	230	£37.99

Premier Range Couplings

FLAT FACE hydraulic couplings - 1/4" - 2" to ISO 16028 sizes

The Holbury FIRG Series Premier Range is used where clean connections are required despite dusty or dirty conditions. Uses include:

- Agriculture
- Construction plant
- Mobile equipment
- General industrial
- Nuclear
- Mining

Construction

- High working and burst pressure
- Excellent fatigue life
- Robust construction
- Female coupling seal swaged-in to prevent extrusion under pressure

Flat Face Coupling

Female Thread BSPP



Working Pressure:
180 bar to 315 bar
(2610 psi to 4568 psi)



PGC: 285	BSPP	Working Pressure (bar)	Price
HQR1/4F-FIRG	1/4	315	£28.64
HQR3/8F-FIRG	3/8	300	£29.98
HQR1/2F-FIRG	1/2	300	£31.22
HQR3/4F-FIRG	3/4	250	£53.97
HQR1F-FIRG	1	250	£127.17
HQR11/4F-FIRG	1 1/4	250	£180.16
HQR11/2F-FIRG	1 1/2	200	£688.11
HQR2F-FIRG	2	180	£1106.35

Flat Face Plug

Female Thread BSPP



Working Pressure:
180 bar to 315 bar
(2610 psi to 4568 psi)



PGC: 285	BSPP	Working Pressure (bar)	Price
HQR1/4M-FIRG	1/4	315	£17.38
HQR3/8M-FIRG	3/8	300	£17.74
HQR1/2M-FIRG	1/2	300	£19.46
HQR3/4M-FIRG	3/4	250	£36.47
HQR1M-FIRG	1	250	£64.96
HQR11/4M-FIRG	1 1/4	250	£108.51
HQR11/2M-FIRG	1 1/2	200	£400.60
HQR2M-FIRG	2	180	£577.44



ISO Couplings

Series A Interchange Couplings



Temperature Range:
-25°C to +120°C
(with standard nitrile seals)
-25°C to +175°C
(with standard viton seals)



Working Pressure:
200 bar to 350 bar
(2900 psi to 5076 psi)
for carbon steel



Working Pressure:
125 bar to 250 bar
(1800 psi to 3600 psi)
for stainless steel

ISO A Series couplings can be used when the fluid transfer lines need to be connected and disconnected for operation or maintenance of equipment. Rugged construction makes this series a good choice for mobile applications including dump trucks, snow plows, refuse hauling, mining, asphalt paving, truck trailer connections and many more.

This series couplings are used in a wide range of hydraulic applications including:

- Construction equipment,
- Manufacturing machinery
- In-plant systems.

ISO A Interchange Coupling

Carbon Steel with Nitrile Seal Female NPT



PGC: 284	NPT	Price
HQRC-1/4N-ISO-A	1/4	£10.38
HQRC-3/8N-ISO-A	3/8	£12.89
HQRC-1/2N-ISO-A	1/2	£13.38
HQRC-3/4N-ISO-A	3/4	£24.01
HQRC-1N-ISO-A	1"	£35.13

ISO A Interchange Coupling

Stainless Steel with Nitrile Seal Female NPT



PGC: 284	NPT	Price
HQRC-1/4N-ISO-A-316	1/4	£29.22
HQRC-3/8N-ISO-A-316	3/8	£45.12
HQRC-1/2N-ISO-A-316	1/2	£80.44
HQRC-3/4N-ISO-A-316	3/4	£120.88
HQRC-1N-ISO-A-316	1"	£179.88

ISO A Interchange Probe

Carbon Steel with Nitrile Seal Female NPT



PGC: 284	NPT	Price
HQRP-1/4N-ISO-A	1/4	£6.89
HQRP-3/8N-ISO-A	3/8	£7.28
HQRP-1/2N-ISO-A	1/2	£7.43
HQRP-3/4N-ISO-A	3/4	£11.51
HQRP-1N-ISO-A	1"	£18.40

ISO A Interchange Probe

Stainless Steel with Nitrile Seal Female NPT



PGC: 284	NPT	Price
HQRP-1/4N-ISO-A-316	1/4	£17.61
HQRP-3/8N-ISO-A-316	3/8	£21.75
HQRP-1/2N-ISO-A-316	1/2	£30.80
HQRP-3/4N-ISO-A-316	3/4	£48.86
HQRP-1N-ISO-A-316	1"	£72.32

ISO A Interchange Coupling

Carbon Steel with Nitrile Seal Female BSPP



PGC: 284	BSPP	Price
HQRC-1/4-ISO-A	1/4	£7.82
HQRC-3/8-ISO-A	3/8	£10.92
HQRC-1/2-ISO-A	1/2	£11.41
HQRC-3/4-ISO-A	3/4	£10.92
HQRC-1-ISO-A	1"	£33.16

ISO A Interchange Coupling

Stainless Steel with Viton Seal Female BSPP



PGC: 284	BSPP	Price
HQRC-1/4-ISO-A-316V	1/4	£27.26
HQRC-3/8-ISO-A-316V	3/8	£45.12
HQRC-1/2-ISO-A-316V	1/2	£80.44
HQRC-3/4-ISO-A-316V	3/4	£120.88
HQRC-1-ISO-A-316V	1"	£179.88

Dust Plug



PGC: 284	Size (")	Price
DP-ISO-A-1/4	1/4	£1.28
DP-ISO-A-3/8	3/8	£1.62
DP-ISO-A-1/2	1/2	£2.21
DP-ISO-A-3/4	3/4	£2.76
DP-ISO-A-1	1"	£3.44

ISO A Interchange Probe

Carbon Steel Nitrile Seal BSPP



PGC: 284	BSPP	Price
HQRP-1/4-ISO-A	1/4	£4.92
HQRP-3/8-ISO-A	3/8	£5.31
HQRP-1/2-ISO-A	1/2	£5.46
HQRP-3/4-ISO-A	3/4	£9.54
HQRP-1-ISO-A	1"	£16.43

ISO A Interchange Probe

Stainless Steel with Viton Seal Female BSPP



PGC: 284	BSPP	Price
HQRP-1/4-ISO-A-316V	1/4	£15.65
HQRP-3/8-ISO-A-316V	3/8	£19.78
HQRP-1/2-ISO-A-316V	1/2	£28.83
HQRP-3/4-ISO-A-316V	3/4	£46.89
HQRP-1-ISO-A-316V	1"	£70.36

Dust Cap



PGC: 284	Size (")	Price
DC-ISO-A-1/4	1/4	£1.28
DC-ISO-A-3/8	3/8	£1.62
DC-ISO-A-1/2	1/2	£2.21
DC-ISO-A-3/4	3/4	£2.76
DC-ISO-A-1	1"	£3.44

ISO B

ISO B Series general purpose couplings, are used across the spectrum of hydraulic applications. These Double Shut-Off couplings can be found anywhere that fluid transfer lines need to be connected and disconnected for operation or maintenance of equipment, and a loss of fluid is undesirable. Primarily used with hydraulic fluid, general purpose Double Shut-Off couplings are typically used in:

- Food processing and manufacture
- Shipbuilding
- Offshore



Temperature Range:
-25°C to +120°C
(with standard nitrile seals)
-25°C to +175°C
(with standard viton seals)



Working Pressure:
200 bar to 350 bar
(2900 psi to 5076 psi)
for carbon steel



Working Pressure:
125 bar to 250 bar
(1800 psi to 3600 psi)
for stainless steel

ISO B Interchange Coupling

Carbon Steel with Nitrile Seal Female BSPP



PGC: 284	BSPP	Price
HQRC-1/4-ISO-B	1/4	£13.78
HQRC-3/8-ISO-B	3/8	£16.24
HQRC-1/2-ISO-B	1/2	£25.98
HQRC-3/4-ISO-B	3/4	£30.65
HQRC-1-ISO-B	1"	£47.18

ISO B Interchange Probe

Carbon Steel with Nitrile Seal Female BSPP



PGC: 284	BSPP	Price
HQRP-1/4-ISO-B	1/4	£5.56
HQRP-3/8-ISO-B	3/8	£7.68
HQRP-1/2-ISO-B	1/2	£9.25
HQRP-3/4-ISO-B	3/4	£9.89
HQRP-1-ISO-B	1"	£16.09

ISO B Interchange Coupling

Carbon Steel Nitrile Seal NPT



PGC: 284	NPT	Price
HQRC-1/8N-ISO-B	1/8	£15.74
HQRC-1/4N-ISO-B	1/4	£15.74
HQRC-3/8N-ISO-B	3/8	£18.20
HQRC-1/2N-ISO-B	1/2	£27.95
HQRC-3/4N-ISO-B	3/4	£32.62
HQRC-1N-ISO-B	1"	£49.15

ISO B Interchange Probe

Carbon Steel with Nitrile Seal Female NPT



PGC: 284	NPT	Price
HQRP-1/4N-ISO-B	1/4	£7.53
HQRP-3/8N-ISO-B	3/8	£9.64
HQRP-1/2N-ISO-B	1/2	£11.27
HQRP-3/4N-ISO-B	3/4	£11.86
HQRP-1N-ISO-B	1"	£18.15

ISO B Interchange Coupling

Stainless Steel with Nitrile Seal Female BSPP



PGC: 284	BSPP	Price
HQRC-1/4-ISO-B-316	1/4	£43.89
HQRC-3/8-ISO-B-316	3/8	£60.07
HQRC-1/2-ISO-B-316	1/2	£95.79
HQRC-3/4-ISO-B-316	3/4	£117.10
HQRC-1-ISO-B-316	1"	£236.85

ISO B Interchange Probe

Stainless Steel with Nitrile Seal Female BSPP



PGC: 284	BSPP	Price
HQRP-1/4-ISO-B-316	1/4	£17.96
HQRP-3/8-ISO-B-316	3/8	£27.21
HQRP-1/2-ISO-B-316	1/2	£36.51
HQRP-3/4-ISO-B-316	3/4	£48.76
HQRP-1-ISO-B-316	1"	£94.81

ISO B Interchange Coupling

Stainless Steel with Nitrile Seal Female NPT



PGC: 284	NPT	Price
HQRC-1/4N-ISO-B-316	1/4	£45.66
HQRC-3/8N-ISO-B-316	3/8	£62.04
HQRC-1/2N-ISO-B-316	1/2	£97.76
HQRC-3/4N-ISO-B-316	3/4	£119.06
HQRC-1N-ISO-B-316	1"	£238.82

ISO B Interchange Probe

Stainless Steel with Nitrile Seal Female NPT



PGC: 284	NPT	Price
HQRP-1/4N-ISO-B-316	1/4	£17.37
HQRP-3/8N-ISO-B-316	3/8	£19.93
HQRP-1/2N-ISO-B-316	1/2	£29.18
HQRP-3/4N-ISO-B-316	3/4	£50.73
HQRP-1N-ISO-B-316	1"	£96.78

ISO B Interchange Coupling

Stainless Steel with Viton Seal Female BSPP



PGC: 284	BSPP	Price
HQRC-1/8-ISO-B-316V	1/8	£36.31
HQRC-1/4-ISO-B-316V	1/4	£46.30
HQRC-3/8-ISO-B-316V	3/8	£66.81
HQRC-1/2-ISO-B-316V	1/2	£105.19
HQRC-3/4-ISO-B-316V	3/4	£140.22
HQRC-1-ISO-B-316V	1	£222.09

ISO B Interchange Probe

Stainless Steel with Viton Seal Female BSPP



PGC: 284	BSPP	Price
HQRP-1/8-ISO-B-316V	1/8	£18.99
HQRP-1/4-ISO-B-316V	1/4	£19.88
HQRP-3/8-ISO-B-316V	3/8	£27.31
HQRP-1/2-ISO-B-316V	1/2	£38.97
HQRP-3/4-ISO-B-316V	3/4	£59.24
HQRP-1-ISO-B-316V	1"	£98.20

Dust Plug and Cap



PGC: 284	Size (")	Price
DCP-ISO-B-1/4	1/4	£1.53
DCP-ISO-B-3/8	3/8	£1.97
DCP-ISO-B-1/2	1/2	£2.61
DCP-ISO-B-3/4	3/4	£3.69
DCP-ISO-B-1	1"	£4.58

ISO B Interchange Coupling

Brass with Nitrile Seal Female BSPP



PGC: 284	BSPP	Price
HQRC-1/8-ISO-B-BR	1/8	£24.21
HQRC-1/4-ISO-B-BR	1/4	£24.21
HQRC-3/8-ISO-B-BR	3/8	£33.55
HQRC-1/2-ISO-B-BR	1/2	£53.43
HQRC-3/4-ISO-B-BR	3/4	£90.28
HQRC-1-ISO-B-BR	1"	£133.68

ISO B Interchange Probe

Brass with Nitrile Seal Female BSPP



PGC: 284	BSPP	Price
HQRP-1/8-ISO-B-BR	1/8	£7.68
HQRP-1/4-ISO-B-BR	1/4	£8.81
HQRP-3/8-ISO-B-BR	3/8	£11.91
HQRP-1/2-ISO-B-BR	1/2	£18.94
HQRP-3/4-ISO-B-BR	3/4	£30.41
HQRP-1-ISO-B-BR	1"	£50.77

ISO 16028

ISO B Series general purpose couplings, are used across the spectrum of hydraulic applications. These Double Shut-Off couplings can be found anywhere that fluid transfer lines need to be connected and disconnected for operation or maintenance of equipment, and a loss of fluid is undesirable. Primarily used with hydraulic fluid, general purpose Double Shut-Off couplings are typically used in:

- Food processing and manufacture
- Shipbuilding
- Offshore



Temperature Range:
 -25°C to +120°C
 (with standard nitrile seals)
 -25°C to +175°C
 (with standard viton seals)



Working Pressure:
 200 bar to 315 bar
 (2900 psi to 5076 psi)
 for carbon seal

Flat Face Coupling

Female BSPP



PGC: 284	BSPP	Price
HQRC-1/8-ISO-B-BR	1/8	£24.21
HQRC-1/4-ISO-B-BR	1/4	£24.21
HQRC-3/8-ISO-B-BR	3/8	£33.55
HQRC-1/2-ISO-B-BR	1/2	£53.43
HQRC-3/4-ISO-B-BR	3/4	£90.28
HQRC-1-ISO-B-BR	1"	£133.68

Flat Face Probe

Female BSPP



PGC: 284	BSPP	Price
HQRP-1/8-ISO-B-BR	1/8	£7.68
HQRP-1/4-ISO-B-BR	1/4	£8.81
HQRP-3/8-ISO-B-BR	3/8	£11.91
HQRP-1/2-ISO-B-BR	1/2	£18.94
HQRP-3/4-ISO-B-BR	3/4	£30.41
HQRP-1-ISO-B-BR	1"	£50.77

Probe Dust Cap



PGC: 284	Size (")	Price
DP-ISO-FF-1/4	1/4	£1.48
DP-ISO-FF-3/8	3/8	£1.77
DP-ISO-FF-1/2	1/2	£2.66
DP-ISO-FF-3/4	3/4	£3.99
DP-ISO-FF-1	1"	£5.56

Dust Plug



PGC: 284	Size (")	Price
DC-ISO-FF-1/4	1/4	£1.48
DC-ISO-FF-3/8	3/8	£1.77
DC-ISO-FF-1/2	1/2	£2.66
DC-ISO-FF-3/4	3/4	£3.99
DC-ISO-FF-1	1"	£5.56



Bonded Washers

Metric Threaded Washers

BSPP Threaded Washers

Bonded Washer

Nitrile Seal
Steel
To suit BSPP Threads



PGC: 286	BSPP	Price
DS2	1/8	£0.33
DS4	1/4	£0.33
DS6	3/8	£0.33
DS8	1/2	£0.37
DS10	5/8	£0.57
DS12	3/4	£0.51
DS14	7/8	£0.75
DS16	1	£0.76
DS20	1 1/4	£1.64
DS24	1 1/2	£1.86
DS32	2	£2.80

Viton Seal

PGC: 286	BSPP	Price
DS2V	1/8	£4.13
DS4V	1/4	£5.11
DS6V	3/8	£6.06
DS8V	1/2	£6.99
DS12V	3/4	£7.79
DS16V	1	£8.78
DS20V	1 1/4	£10.81
DS24V	1 1/2	£12.45
DS32V	2	£18.29

Bonded Washer

Nitrile Seal
Stainless Steel
To suit BSPP Threads



PGC: 286	BSPP	Price
DS2SS	1/8	£4.20
DS4SS	1/4	£4.34
DS6SS	3/8	£4.84
DS8SS	1/2	£5.74
DS12SS	3/4	£6.63
DS16SS	1	£13.98
DS20SS	1 1/4	£18.68
DS24SS	1 1/2	£24.63
DS32SS	2	£32.53

Viton Seal

PGC: 286	BSPP	Price
DS2VSS	1/8	£8.65
DS4VSS	1/4	£9.73
DS6VSS	3/8	£10.44
DS8VSS	1/2	£11.25
DS12VSS	3/4	£12.28
DS16VSS	1	£19.18
DS20VSS	1 1/4	£25.91
DS24VSS	1 1/2	£32.27
DS32VSS	2	£66.66

Bonded Washer

Nitrile Seal
Steel
To suit Metric Threads



PGC: 286	Thread	Price
DS6M	M6	£0.56
DS8M	M8	£0.56
DS10M	M10	£0.56
DS12M	M12	£0.45
DS14M	M14	£0.45
DS16M	M16	£0.51
DS18M	M18	£0.56
DS20M	M20	£0.59
DS22M	M22	£0.62
DS30M	M30	£1.23

Plastic Plugs & Caps

Plastic Plug



PGC: 328	BSPP	Price
PP2	1/8	£0.46
PP4	1/4	£0.55
PP6	3/8	£0.55
PP8	1/2	£0.55
PP12	3/4	£0.60
PP16	1	£0.83
PP20	1 1/4	£1.41
PP24	1 1/2	£1.44
PP32	2	£1.53

Plastic Cap



PGC: 328	BSPP	Price
PC2	1/8	£0.45
PC4	1/4	£0.52
PC6	3/8	£0.52
PC8	1/2	£0.52
PC12	3/4	£0.59
PC16	1	£0.82
PC20	1 1/4	£1.14
PC24	1 1/2	£1.17
PC32	2	£1.38

O-Ring Kits

O-Ring Kit



PGC: 223	Type	Price
ORK	Imperial	£17.96
ORKM	Metric	£17.96